

Operator's manual

TruConvert AC 3025
TruConvert System Control

TruConvert Modular

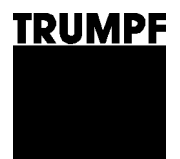

Operator's manual

TruConvert AC 3025
TruConvert System Control
TruConvert Modular

Original operator's manual

Edition **2023-07-10**

Order Information

Please specify when ordering this document:

Operator's manual

TruConvert AC 3025 TruConvert System Control

Edition 2023-07-10

Document number A67-0141-00.BKen-001-10

Address for orders

TRUMPF Hüttinger GmbH + Co. KG

Technische Redaktion

Bötzingen Straße 80

D-79111 Freiburg

Fon: +49 761 8971 - 0

Fax: +49 761 8971 - 1150

Internet: <http://www.trumpf-huettinger.com>

E-Mail: info.elektronik@de.trumpf.com

Good to know

Need help? Provide the **serial number** when you contact the Service department.

How to reach our Service department:

Telephone +49 761 8971-2170

Fax +49 761 8971-1178

E-Mail service.electronic@trumpf.com

Where can the serial number be found?

- On the name plate of the device (top).
- On the front and rear side of the device.
- Web GUI, menu path: >About, "Identification".

Position of the serial number

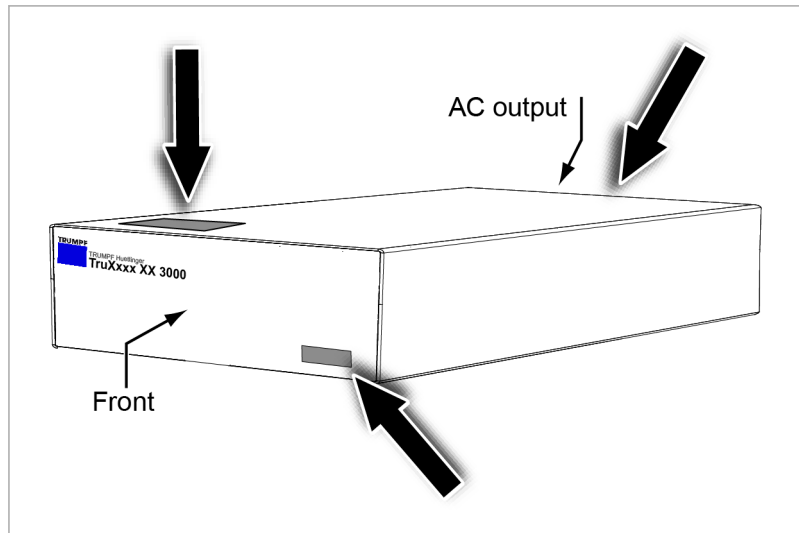

Position of the serial number on the TruConvert AC

Fig. 1

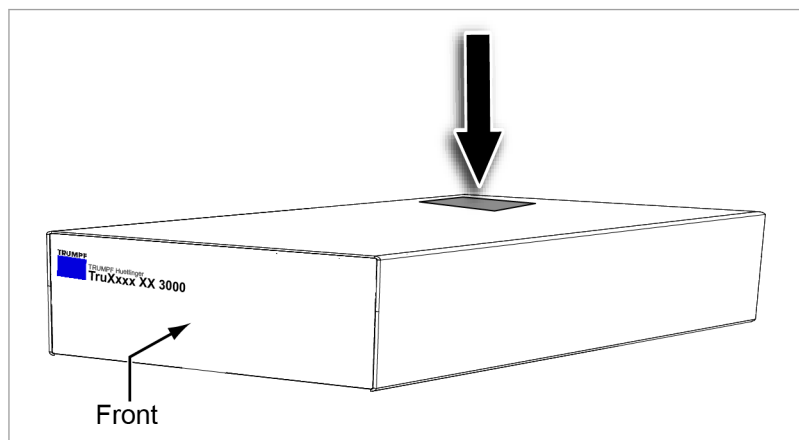

Position of the serial number on the TruConvert System Control

Fig. 2



Table of contents

1	Safety	5
1.1	Storing the operating instructions	5
1.2	Warning signs	5
1.3	Using the device	6
1.4	Authorized personnel	6
1.5	Warning signs on the AC-DC module	7
1.6	Meaning of the warning signs	7
1.7	Dangers from high voltages	8
	Protective measures taken by the manufacturer	9
1.8	Device damages from improper handling	9
1.9	Ensuring safe operation of the device	9
2	Description	11
2.1	Fields of application	11
2.2	Function description	11
2.3	Configurations	11
2.4	Construction	14
	Overview	15
	Rear side	15
	Display elements	16
3	Technical specifications	17
3.1	Data TruConvert AC 3025	17
3.2	TruConvert System Control data	25
4	Interfaces	27
4.1	Mains power connection	27
4.2	Potential equalization	28
4.3	DC link	28
4.4	Contactor release contact and mains voltage measurement	29
4.5	24 V supply voltage (DC)	30
4.6	Communication interfaces	30
4.7	Interfaces on the system control	31
	24 V supply voltage (DC)	31
	Ethernet	32



	RS-485	33
5	Standards and directives	34
5.1	CE certification	34
5.2	EU declaration of conformity TruConvert AC 3025	35
5.3	EU declaration of conformity TruConvert System Control	36
6	Installation	37
6.1	Inspecting the delivery	37
6.2	Disposing of packaging material	37
6.3	Transport	37
6.4	Storage conditions	37
6.5	Requirements for the site	38
6.6	Electrical connection	40
	Establishing electrical connection	40
	Connection diagram	44
	Connection acc. to IEC 62109-2	45
	Connection according to AS/NZS 4777.2	53
6.7	Requirements for grid-forming mode	57
6.8	Series-connected batteries on DC link	60
	Connecting 2 batteries in series	60
6.9	Dismantling	61
6.10	Shipping the module	62
6.11	Disposing of the module	62
7	Operation	63
7.1	Commissioning	63
	Performing initial commissioning	63
7.2	Active interface	69
7.3	Operation via web-based user interface	70
	Calling up the web GUI	70
	Orientation of the user interface	70
	Menu structure	74
7.4	Operation via Modbus	74
	Establishing a connection	75
	Addressing modules via Modbus	75
	Modbus Register Map	77
7.5	Transmission of power	91
	Switching the transmission of power on/off	91

7.6	Displaying and resetting messages	94
	Displaying messages of the web GUI	94
	Modbus: displaying and resetting messages	97
7.7	Overload	98
	Operating with overload	98
	Examples: Reduce and then again increase overload capacity	100
7.8	Actual values	100
	Display actual values	100
7.9	Process set values	101
	Set process set values	101
7.10	DC link	101
	Setting DC link with "voltage regulation" regulator type	101
	Setting DC link with "mains current regulation" regulator type	104
7.11	Operation with voltage regulation (grid-forming or grid-following mode)	106
	Function description "Operation with voltage regulation"	106
	Setting operation with voltage regulation	109
	Parameterization "Operation with voltage regulation"	111
	Further information on "Operation with voltage regulation"	114
7.12	Operation with series-connected batteries	117
	Function description "Operation with series-connected batteries"	117
	Setting "Operation with series-connected batteries"	118
	Parameterization "Operation with series-connected batteries"	119
7.13	Data backup	120
	Saving parameters and resetting to factory settings	120
7.14	System configuration	121
	Setting the system configuration	121
7.15	Setting grid codes	123
7.16	System settings	125
	Setting the system time	125
	Changing network settings	126
7.17	Software update	127
	Perform software update	127

7.18	Device information	128
	Displaying device information	128
7.19	State diagram	129
8	Maintenance	130
8.1	Periodic check of the environmental conditions	130
8.2	Cleaning	130
8.3	Exchanging fans	130
8.4	Performing software updates	130
9	Troubleshooting	131
9.1	Fault indication and messages	131
	Fault indication with the LEDs	131
9.2	Messages	131

1. Safety

1.1 Storing the operating instructions



IMPORTANT SAFETY INSTRUCTIONS

- SAVE THESE INSTRUCTIONS.
-

These operating instructions contain safety notices that must be observed during installation and maintenance. Therefore, keep the operating instructions in a safe place for the entire life cycle of the device.

Include the operating instructions if you sell the device or set it up at another location.

1.2 Warning signs

Certain activities can cause danger during operation. Corresponding warning signs concerning the dangers should precede instructions concerning the activities. Danger signs are located on the device.

A warning sign contains signal words which are explained in the following table:

Signal word	Description
DANGER (DANGER)	Indicates a major danger. If it is not avoided, serious injuries or death will result.
WARNING (WARNING)	Indicates a dangerous situation. If it is not avoided, it may lead to serious injuries.
CAUTION (CAUTION)	Indicates a potentially dangerous situation. If it is not avoided, injuries may occur.
NOTICE (NOTICE)	If such a situation is ignored, material damage may result.

Description of the signal words

Tab. 1

1.3 Using the device

- Typical fields of application** The device is a bidirectional inverter. It is used for charging a DC link from a three-phase grid and for feeding the grid from the DC link's energy.
- The power and the energy flow direction are adjustable.
 - The device draws sinusoidal current from the mains or delivers sinusoidal current to the mains. The power factor $\cos\phi$ is adjustable.
 - The DC link voltage is balanced to earth.
- Liability exclusion** Any use not listed under "Typical fields of application" contravenes the intended purpose. TRUMPF is not liable for any ensuing damages, in particular for property damage, personal injury and loss of production. The operator bears all risks. The warranty is rendered null and void.
- Impermissible uses** Impermissible uses include, for example:
- Use of incorrect components.
 - Operation on mains voltage outside the specification.
 - Faulty installation (e.g., cables reversed).
 - Use in unauthorized installation position.
 - Misuse by untrained personnel.
 - Use in unsuitable environmental conditions:
 - Condensation, icing.
 - Conductive soiling.
 - Corrosive conditions (e.g. battery fumes, salt spray).
 - Voltages outside of overvoltage category III (max. 4 kV impulse withstand voltage).
 - Operation at more than 2000 m above sea level.
 - Outdoors.
 - Failure to observe pollution degree 2 environmental condition.
 - In an explosive environment.

1.4 Authorized personnel

- Authorized personnel** Authorized persons must, given their authorization, training and instruction, be capable of understanding their tasks and recognizing potential dangers. Therefore, authorized persons must be trained and be familiar with the standards and regulations relevant to their tasks.
- It is the duty and responsibility of the operator to maintain the qualifications of the authorized personnel through regular training.

The following activities may only be performed by authorized persons:

- Positioning
- Connect
- Dismantling
- Operation

1.5 Warning signs on the AC-DC module

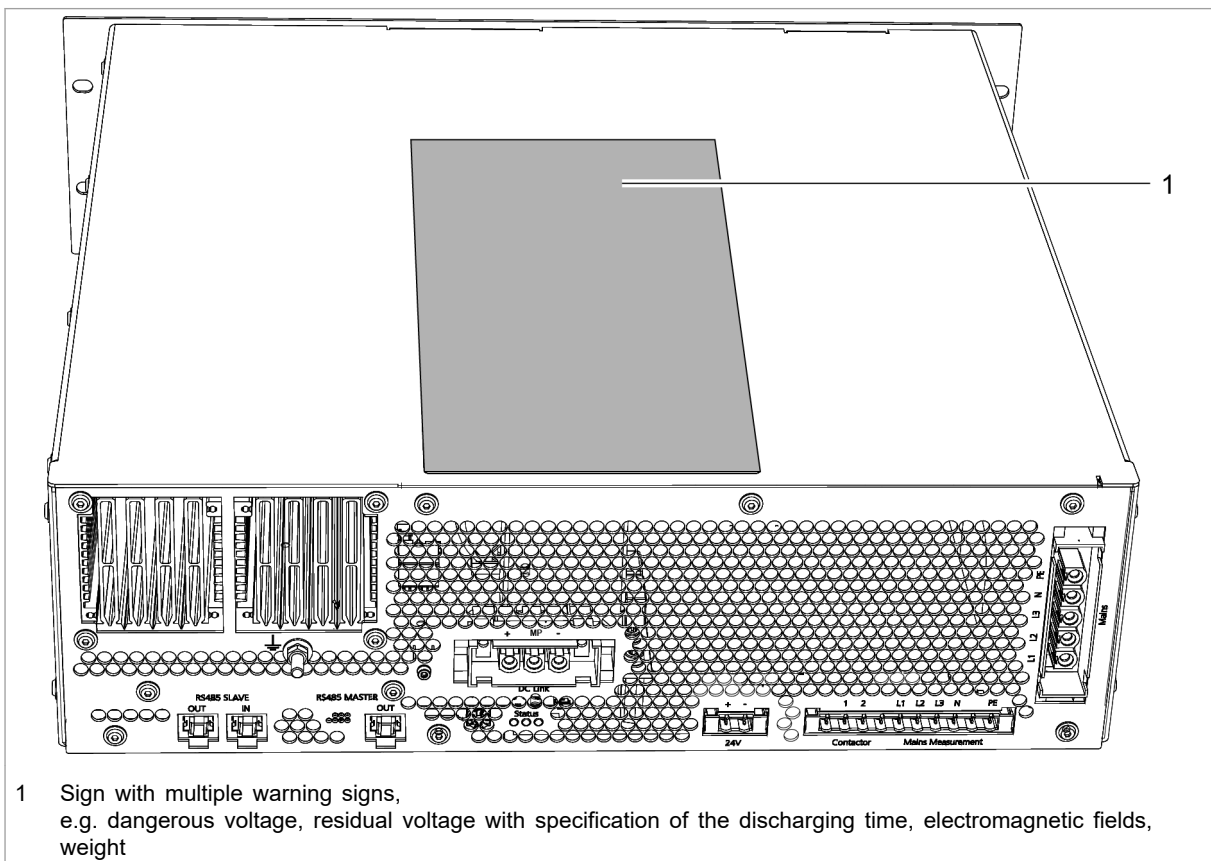

1 Sign with multiple warning signs, e.g. dangerous voltage, residual voltage with specification of the discharging time, electromagnetic fields, weight

Warning signs on the AC-DC module







Fig. 3

1.6 Meaning of the warning signs

Note

All warning signs must be present and legible.

If one or more of these warning signs is missing or not legible, contact TRUMPF to request new warning signs.

Warning sign			Meaning
<p>⚠ WARNING</p> <p>HAZARDOUS VOLTAGE Contact may cause electric shock or burn. Turn off and lock out power before servicing.</p>		<p>⚠ AVERTISSEMENT</p> <p>TENSION DANGEREUSE Le contact peut provoquer un choc électrique ou des brûlures. Couper et sécuriser l'alimentation électrique avant toute maintenance.</p>	Sign warns of hazardous voltage.
<p>⚠ WARNING</p> <p>RISK OF ELECTRIC SHOCK Do not remove cover. No user serviceable parts inside. Refer servicing to qualified personnel.</p>		<p>⚠ AVERTISSEMENT</p> <p>RISQUE DE CHOC ÉLECTRIQUE Ne pas retirer le capot. Aucune pièce réparable par l'utilisateur à l'intérieur. Confiez l'entretien à un personnel qualifié.</p>	Sign warns of electric shock.
<p>⚠ WARNING</p> <p>RISK OF ELECTRIC SHOCK AC and DC voltage sources are terminated inside this equipment. Disconnect each circuit individually. Service personnel must wait 5 minutes before servicing.</p>		<p>⚠ AVERTISSEMENT</p> <p>RISQUE DE CHOC ÉLECTRIQUE Les sources de tension CA et CC sont fermées à l'intérieur de l'équipement. Déconnectez chaque circuit individuellement. Le personnel de maintenance doit attendre 5 minutes avant d'intervenir.</p>	Sign warns of hazardous voltage. Sign warns of hazardous residual voltage.
<p>⚠ WARNING</p> <p>HEAVY OBJECT Can cause muscle strain or back injury. Use lifting aids and proper lifting techniques when removing or replacing.</p>		<p>⚠ AVERTISSEMENT</p> <p>OBJET LOURD Risque de claquage musculaire ou de blessure au dos. Utiliser des outils et des techniques de levage appropriées pour l'enlèvement ou le remplacement.</p>	This sign warns of dangers that arise from the weight of the device.
<p>⚠ CAUTION</p> <p>Touch current may be above 3.5 mA and can cause discomfort. Connecting the protective earth as described in the installation instruction will eliminate the hazard.</p>		<p>⚠ ATTENTION</p> <p>Le courant de contact peut être supérieur à 3,5 mA et peut causer des désagréments. Ce risque est éliminé en connectant le conducteur de terre de protection comme indiqué dans le manuel d'installation.</p>	Sign warns of contact current.
<p>NOTICE</p> <p>DESTRUCTION OF DEVICE A string optimizer is required, when connecting photovoltaic modules to the DC link.</p>		<p>AVIS</p> <p>DESTRUCTION DE L'APPAREIL Un optimiseur de string est nécessaire si des modules photovoltaïques sont connectés au circuit intermédiaire.</p>	Sign warns against connecting the photovoltaic modules without string optimizers.
<p>NOTICE</p> <p>Read the manual. Consult operator's manual for information of required external or ancillary equipment.</p>		<p>AVIS</p> <p>Lire le manuel d'utilisation. Consultez le manuel d'utilisation pour toute information relative à l'équipement extérieur ou auxiliaire nécessaire.</p>	This sign indicates that the operator's manual must be read.
<p>Note</p> <p>Specific Standards: UL 1741 – Second Edition 2016 Including SA IEEE 1547 – 2003 IEC 62109-1 IEEE 1547.1 – 2005 IEC 62109-2 IEEE 1547a – 2014 IEC 62477-1 Requirement for the site: Installation is prohibited in households or areas of similar type or use. WARNING – RCD type B is required on the AC port of the inverter.</p>		<p>Remarque</p> <p>Normes spécifiques : UL 1741 – Seconde édition 2016, y compris SA IEEE 1547 – 2003 IEC 62109-1 IEEE 1547.1 – 2005 IEC 62109-2 IEEE 1547a – 2014 IEC 62477-1 Exigences envers le site : L'installation est interdite dans les zones résidentielles et dans les zones de type ou d'utilisation similaires. AVERTISSEMENT - Un interrupteur différentiel de type B est nécessaire sur le port CA de l'onduleur.</p>	This sign indicates specific properties of the device.

Meaning of the warning signs

Tab. 2

1.7 Dangers from high voltages



Life threatening voltage!

The voltages present at the device are life-threatening.

- Have work on the device performed by trained personnel only.

The device produces voltages that can endanger human life and health. These voltages occur both in the device as well as at the outputs of the device.

The device's connection cables carry voltages that are life-threatening.

A person who comes into contact with live device parts may be killed or severely injured.

WARNING

Simultaneous control via web GUI and Modbus is possible!

Power transmission stopped using the user interface can be started again and reversed via Modbus.

- Before carrying out work on the device, deenergize all supply lines and secure against reenergizing.
 - Make sure that the device is controlled via one channel only (user interface or Modbus).
-

Protective measures taken by the manufacturer

The AC-DC module is installed in an enclosed metal casing.

1.8 Device damages from improper handling

NOTICE

Damage to impact-sensitive components

If the device is set down heavily or tips over, impact-sensitive components inside the device will be damaged (e.g. fans, circuit boards).

- Do **not** set down the device heavily or drop it.
 - Stand the device on its underside or on its side.
 - If necessary, secure the device against tipping over.
-

1.9 Ensuring safe operation of the device

1. Only operate the device within the conditions described in chapter "Technical specifications".
2. The device must not be opened.
3. Only operating personnel **without** pacemaker or implants may work in the operational site.

-
4. For the electrical connection, use only cables that are in perfect condition and have the correct dimensions.
 5. Periodically retest acc. to DGUV regulation 3 (DGUV = Deutsche Gesetzliche Unfallversicherung – German Statutory Accident Insurance Association).

2. Description

2.1 Fields of application

The fields of application are described in chapter **Safety**, (see "Typical fields of application", pg. 6).

Control The **TruConvert System Control** external control must be used to monitor and control the AC-DC module.

2.2 Function description

- Function modes**
- The AC-DC module draws energy from a three-phase grid and feeds it into a DC link.
 - The AC-DC module draws energy from a DC link and feeds it into a three-phase grid.

Description of principle

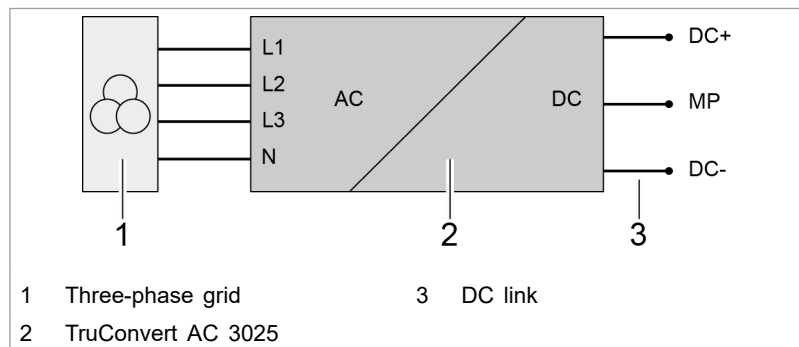

Description of principle

Fig. 4

Operation The AC-DC module can be operated:

- with a PC with a web browser
- via Modbus

In both cases, the **TruConvert System Control** control device must be connected upstream (see "Fig. 5", pg. 12).

2.3 Configurations

- Permissible configurations**
- The TruConvert AC 3025 must always be operated together with a TruConvert System Control.
 - TruConvert AC 3025 can be operated on its own on a DC link ("DC link").

- 16 TruConvert AC 3025 units can be operated simultaneously on the DC link.
- One TruConvert AC 3025 can be operated together with up to 4 TruConvert DC 1008.

Impermissible configurations

- The connection of other DC voltage converters is only permissible in consultation with TRUMPF.
- The parallel connection of TruConvert AC 3025 with other bidirectional inverters on the DC link side is permissible only in consultation with TRUMPF.

One TruConvert System Control controls one TruConvert AC 3025

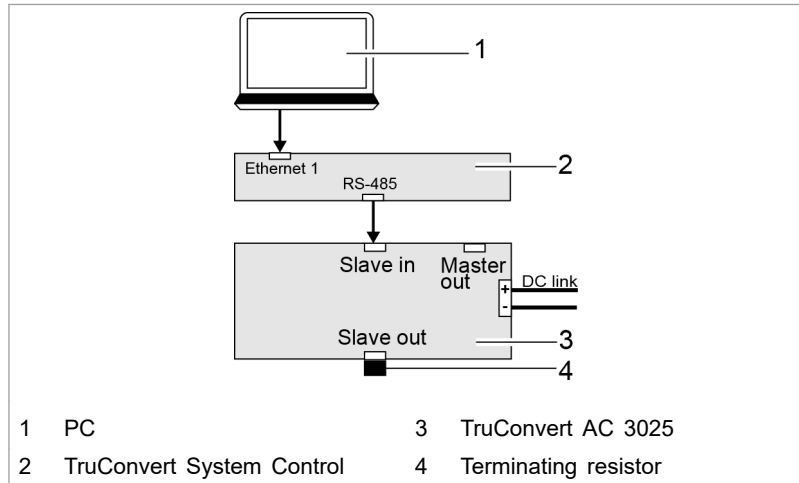

1 x TruConvert System Control, 1 x TruConvert AC 3025

Fig. 5

One TruConvert System Control controls several TruConvert AC 3025

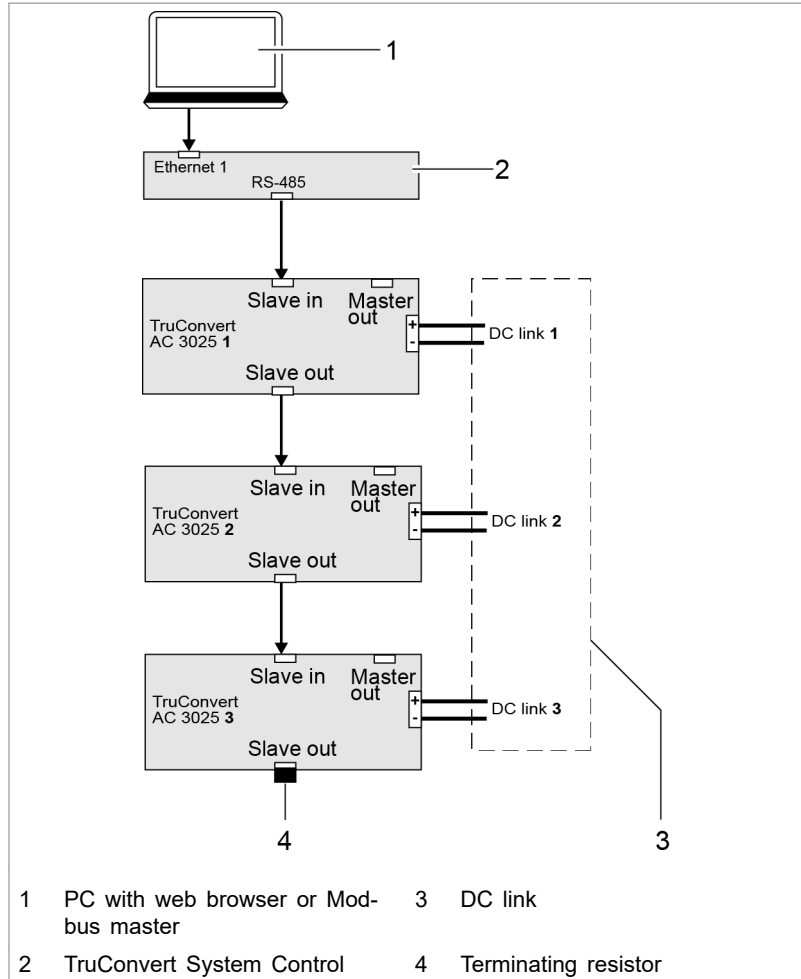

1 x TruConvert System Control, n x TruConvert AC 3025 (n ≤ 16)

Fig. 6

One TruConvert System Control controls one TruConvert AC 3025 and several TruConvert DC 10xx

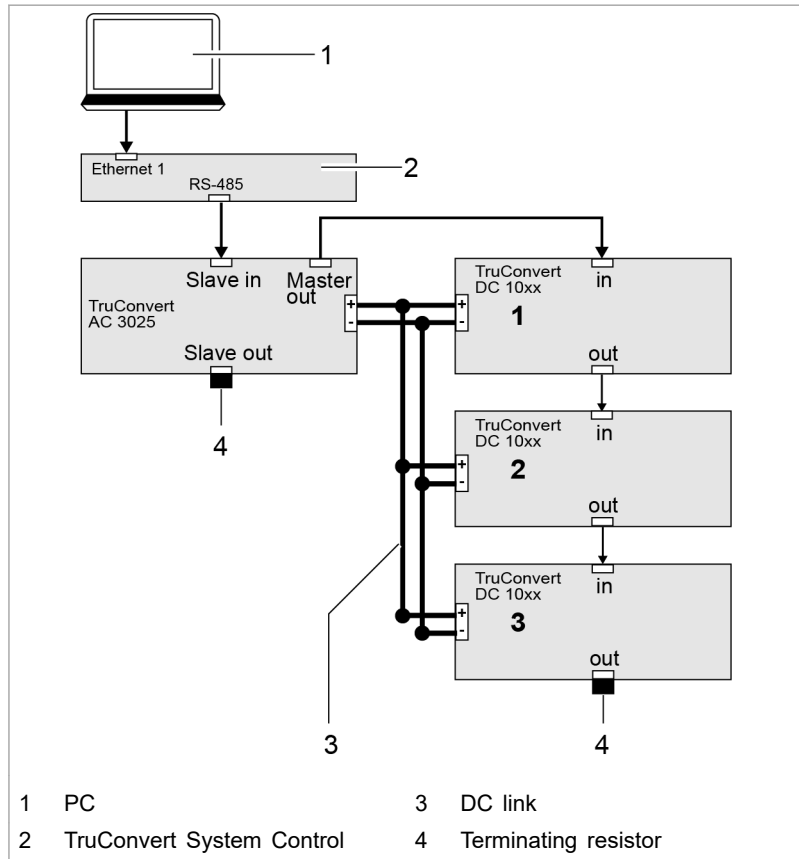

1 TruConvert System Control controls 1 TruConvert AC 3025 and m x TruConvert DC 10xx (m ≤ 4)

Fig. 7

2.4 Construction

The AC-DC module is housed in an enclosed 19-inch metal housing.

Overview

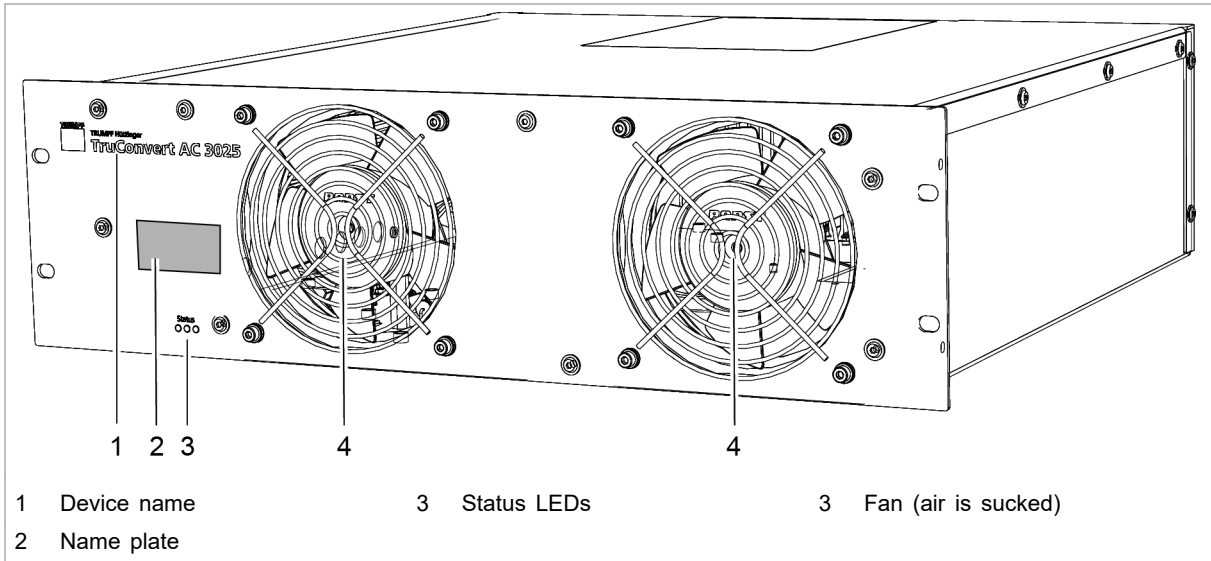

- | | | | | | |
|---|-------------|---|-------------|---|---------------------|
| 1 | Device name | 3 | Status LEDs | 3 | Fan (air is sucked) |
| 2 | Name plate | | | | |

Overall view of the TruConvert AC 3025

Fig. 8

Rear side

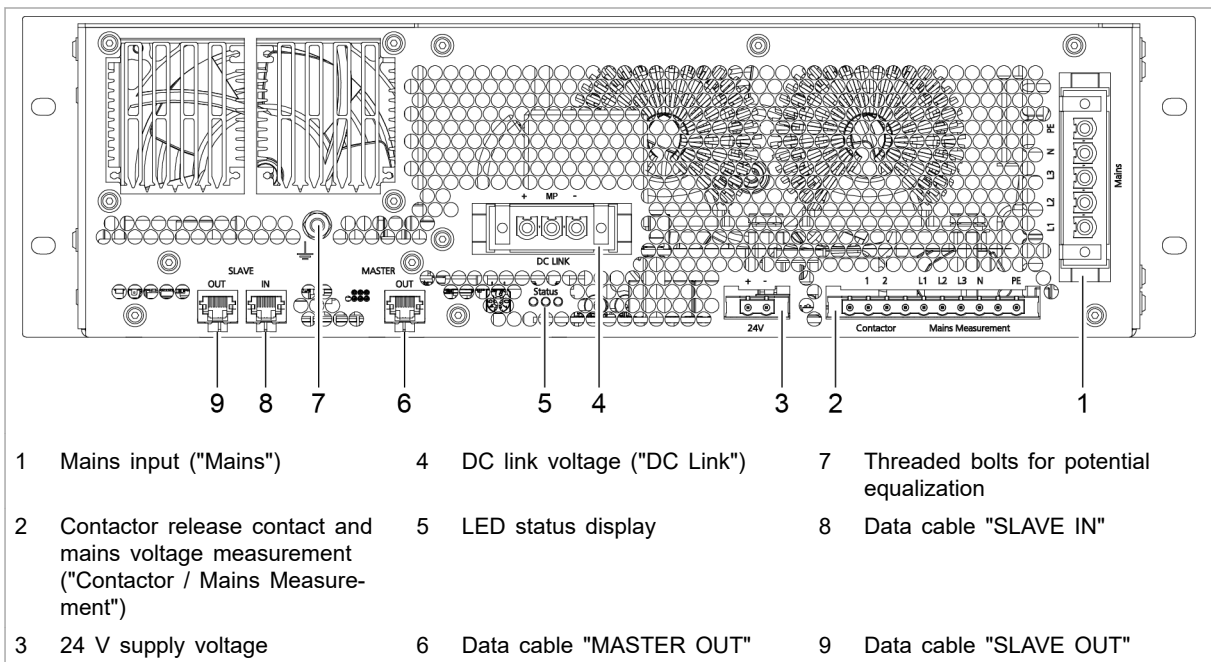

- | | | | | | |
|---|---|---|-----------------------------|---|---|
| 1 | Mains input ("Mains") | 4 | DC link voltage ("DC Link") | 7 | Threaded bolts for potential equalization |
| 2 | Contactor release contact and mains voltage measurement ("Contactor / Mains Measurement") | 5 | LED status display | 8 | Data cable "SLAVE IN" |
| 3 | 24 V supply voltage | 6 | Data cable "MASTER OUT" | 9 | Data cable "SLAVE OUT" |

TruConvert AC 3025 rear side

Fig. 9

Display elements

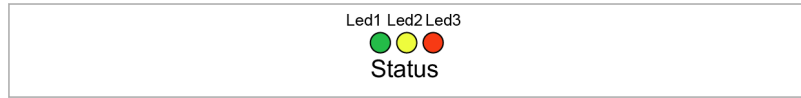

Status LEDs on TruConvert AC 3025 and TruConvert System Control

Fig. 10

LED	Device condition				
	Bootloader	Initialize	Errors	Idling	Operation
1 (green)	on	Flashing	off	Flashing	Flashing
2 (yellow)	Flashing	Flashing	off	off	LED indicates the energy direction. <ul style="list-style-type: none"> ▪ Illuminates if the energy flows from mains to the DC link. ▪ Flashes if the energy flows from the DC link to mains.
3 (red)	on	Flashing	Flashing	off	off

Status LEDs

Tab. 3

3. Technical specifications

3.1 Data TruConvert AC 3025

Entire device	Description	Value
	Max. efficiency	
Voltage supply		24 VDC \pm 10 % / 8 A Note Observe for external fuses: switch-on current is briefly 3 times the nominal current.
Decisive voltage class (DVC)		C
Reaction time for nominal power reversal		Mains current regulation: < 75 ms Voltage regulation: < 200 ms
Protection class according to 62109-1		I
Overvoltage category		III
Grid input		(max. impulse withstand voltage: 4 kV)
Overvoltage category		II
DC link (connection panels for PV system)		

Entire device

Tab. 4

Grid connection data	Description	Value
	Mains voltage range (3 phases)	
Decisive voltage class (DVC)		C
Phase sequence		L1, L2, L3 (required rotating field: clockwise)
Maximum permitted mains voltage		528 V
Mains frequency range		45 Hz to 65 Hz
Nominal mains frequency		50 Hz / 60 Hz
Charging/discharging nominal apparent power		25 kVA
Asymmetrical load		Up to 8.3 kVA/phase Note The nominal current on the neutral conductor must not be exceeded in the case of asymmetry!
Charging/discharging power factor (cos φ)		-1 to 1 Inductive and capacitive phase shift

Grid connection data

Description	Value
Nominal current for listed voltage	380 V: 38 A 400 V: 37 A 415 V: 35 A 440 V: 33 A 460 V: 32 A 480 V: 31 A
Overload capacity 125% (10 min)	32 kVA ¹
Overload capacity 150% (1 min)	37.5 kVA ¹
Excess current capacity 300% (0.5 s island operation)	<ul style="list-style-type: none"> ▪ Mains current regulation: rms value 80 A¹ ▪ Voltage regulation: Limited to absolute value: 125 A (0.5 s)¹
Distortion due to harmonics in nominal power	< 5 %
Maximum grid impedance for flicker (according to AS/NZS 4777.2)	$Z_{\max} = 0.04 \Omega + j0.04 \Omega$
Max. switch-on current	< nominal current
Recommended external fuses / power circuit breakers	380 V: 3 x 50 A 400 V: 3 x 50 A 415 V: 3 x 50 A 440 V: 3 x 40 A 460 V: 3 x 40 A 480 V: 3 x 40 A <ul style="list-style-type: none"> ▪ For region EN / IEC <ul style="list-style-type: none"> - Fuse: EN60127-1/ EN60269-1: gG - Power circuit breaker: IEC/EN 60947-2 - Rated switching capacity [Icu]: 15 kA IEC/EN 60947-2 - Rated current [In]: 50 A - Trigger characteristic: C - Smallest required prospective short-circuit current [Icp, mr]: 230 A (6 x In) ▪ For region UL / CSA <ul style="list-style-type: none"> - Fuse: UL248: Class J time-delay - Power circuit breaker: UL 489 / CSA-C22.2

¹ At ambient temperatures of: charging: -5°C to 35°C, discharging: -5°C to 40°C.

Grid connection data

Description	Value
Mains type	TN-S, TN-C-S, TN-C, 3-phase + N N conductor and PE conductor are not connected in the TruConvert AC 3025. N conductor and PE conductor must be connected outside of the TruConvert AC 3025.
Ground leakage current	< 3 mA (If residual current devices are used: use type B.)
AC short-circuit values	<ul style="list-style-type: none"> ▪ Conditional short-circuit current: Current regulation [I_{CC}]: 80 A rms Voltage regulation: [I_{CC}]: 125 A rms ▪ Rated short-time withstand current [I_{cw}]: 125 A/500 ms ▪ Surge current stability [I_{pk}]: 730 A/ <1 ms ▪ Maximum output residual current [I_{SC}] 24.05 A rms for 3 periods
Active stand-alone network detection	A slight, cyclical grid disturbance is imprinted on the connected AC grid and the corresponding grid response is monitored.

Grid connection data

Tab. 5

DC link

Description	Value
Nominal power charging/discharging (at 40°C / 104°F)	25 kW
Position to ground potential	The DC link is balanced to earth.
DC link nominal current at:	750 V: 36 A 800 V: 33 A 850 V: 31 A 900 V: 30 A 950 V: 28 A
Maximum output voltage	950 VDC
Decisive voltage class (DVC)	C
Maximum voltage between DC+ and PE or DC- and PE	650 VDC

DC link	Description	Value	
	Minimum voltages of the DC-link halves at specified mains voltage ²	Mains voltage	Minimum voltages of DC-link halves ³
	380 V (+10 %)	311 V (345 V)	
	400 V (+10 %)	327 V (360 V)	
	415 V (+10 %)	339 V (375 V)	
	440 V (+10 %)	360 V (400 V)	
	460 V (+10 %)	376 V (415 V)	
	480 V (+10 %)	392 V (435 V)	
DC short-circuit values	<ul style="list-style-type: none"> ▪ Sustained short-circuit current [I_{cc}]: current flow is sustained if: $U_{DC\ link} \geq (30\ V + 2 \times \sqrt{2} \times U_{AC, rms})$ ▪ Surge current stability [I_{pk}]: 4600 A duration < 0.1 ms 		
Allowed battery models	On request		
Allowed battery voltage range (input and output variable)	750 V – 950 V		

- 2 To operate on mains, the voltages of the DC-link halves (DC+ to MP or DC- to MP) must each be greater than the corresponding mains amplitudes.
- 3 Calculation of the minimum voltage of the DC link halves: $\sqrt{2} \times$ mains voltage $\div \sqrt{3}$



DC link

Description	Value
Recommended external fuses	<p>The DC fuses must be provided on-site by the customer.</p> <p>For an installation with max. 4 TruConvert DC 1008/1010, it is – after consulting with TRUMPF – possible to forego the use of DC fuses.</p> <p>The parameters required for dimensioning the fuses depend on the installation situation in the customer system.</p> <p>The following system parameters form the basis for dimensioning:</p> <ul style="list-style-type: none"> ▪ Internal resistances of the sources present in the DC link ▪ Capacitances present in the DC link ▪ Inductivities present in the DC link <p>Note</p> <p>The fuses must be dimensioned such that country-specific requirements are observed.</p> <p>Aging and peak current effects must be taken into consideration! In this case, contact your fuse manufacturer.</p> <p>The following dimensioning of the nominal fuse current yields:</p> $I_{Fuse} \geq I_{Rated} \times 1.56 = 36 \text{ A} \times 1.56 = 56.16 \text{ A}$ <p>The permissible operating voltage of the fuse must be higher than the DC link voltage.</p> <p>Fuse ratings:</p> $U_{Operation} = 1000 \text{ VDC}$ $I_{Rated} = 63 \text{ ADC}$ <p>Suitable model, e.g.: EATON Bussmann PV-63ANH1, size NH1 with suitable holders.</p>

DC link

Tab. 6

PV input variables

Description	Value
$U_{MAX PV}$ (absolute maximum value)	950 V
PV input voltage range	750 V – 950 V
PV input operating current (maximum continuous value) (determined by the TruConvert AC 3025)	36 A
$I_{SC PV}$ (absolute maximum value) (determined by the TruConvert AC 3025)	50 A
Maximum regenerative current of the inverter in the PV system	0 A

PV input variables

Description	Value
Recommended PV string optimizer	Ampt, LLC
PV module type	Class A acc. to IEC 61730

DC link

Tab. 7

Note

If the device is used in a PV system, other requirements must be met (see "Connection acc. to IEC 62109-2", pg. 45).

Derating operation

At ambient temperatures > 40 °C, the output apparent power is reduced.

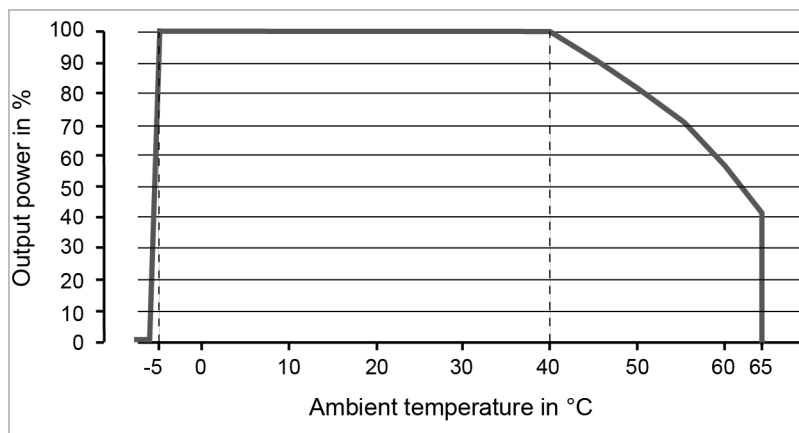

Derating

Fig. 11

Interfaces

Description	Connection
DC link	<ul style="list-style-type: none"> ▪ DC Link <ul style="list-style-type: none"> - PCB plug connector, 3-pin
24 V supply voltage (DC)	<ul style="list-style-type: none"> ▪ 24V <ul style="list-style-type: none"> - PCB plug connector, 2-pin
Mains power connection	<ul style="list-style-type: none"> ▪ L1, L2, L3, N, PE <ul style="list-style-type: none"> - PCB plug connector, 5-pin



Interfaces	Description	Connection
	Measurement of mains voltage and contact for contactor release	<ul style="list-style-type: none"> ▪ Contactor Mains Measurement <ul style="list-style-type: none"> - PCB plug connector, 10-pin Recommended external fuses ▪ Circuit breaker, 4-pin ▪ Current [I]: 1 A ▪ For region EN / IEC acc. to IEC/ EN60947-2: <ul style="list-style-type: none"> - Voltage [V]: 400 V - Rated switching capacity: 10 kA - Shutdown characteristics: Type B ▪ For region UL / CSA acc. to UL489: <ul style="list-style-type: none"> - Voltage [V]: 480Y/277 V - Rated switching capacity: 10 kA - Shutdown characteristics: Type B
	Data output master	<ul style="list-style-type: none"> ▪ MASTER <ul style="list-style-type: none"> - RJ-45
	Data output slave	<ul style="list-style-type: none"> ▪ SLAVE OUT <ul style="list-style-type: none"> - RJ-45
	Data input slave	<ul style="list-style-type: none"> ▪ SLAVE IN <ul style="list-style-type: none"> - RJ-45

Interfaces

Tab. 8

Housing	Description	Value
	Dimensions without connectors (W x H x D)	437 mm x 129 mm x 500 mm 17.20" x 5.08" x 19.69"
	Dimensions of front panel W x H	482 mm x 132 mm 19" x 5.20"
	Weight	27 kg
	Housing material	Body: galvanized sheet steel Front: stainless steel
	Protection class	IP 20

Housing data

Tab. 9

Dimensional drawing

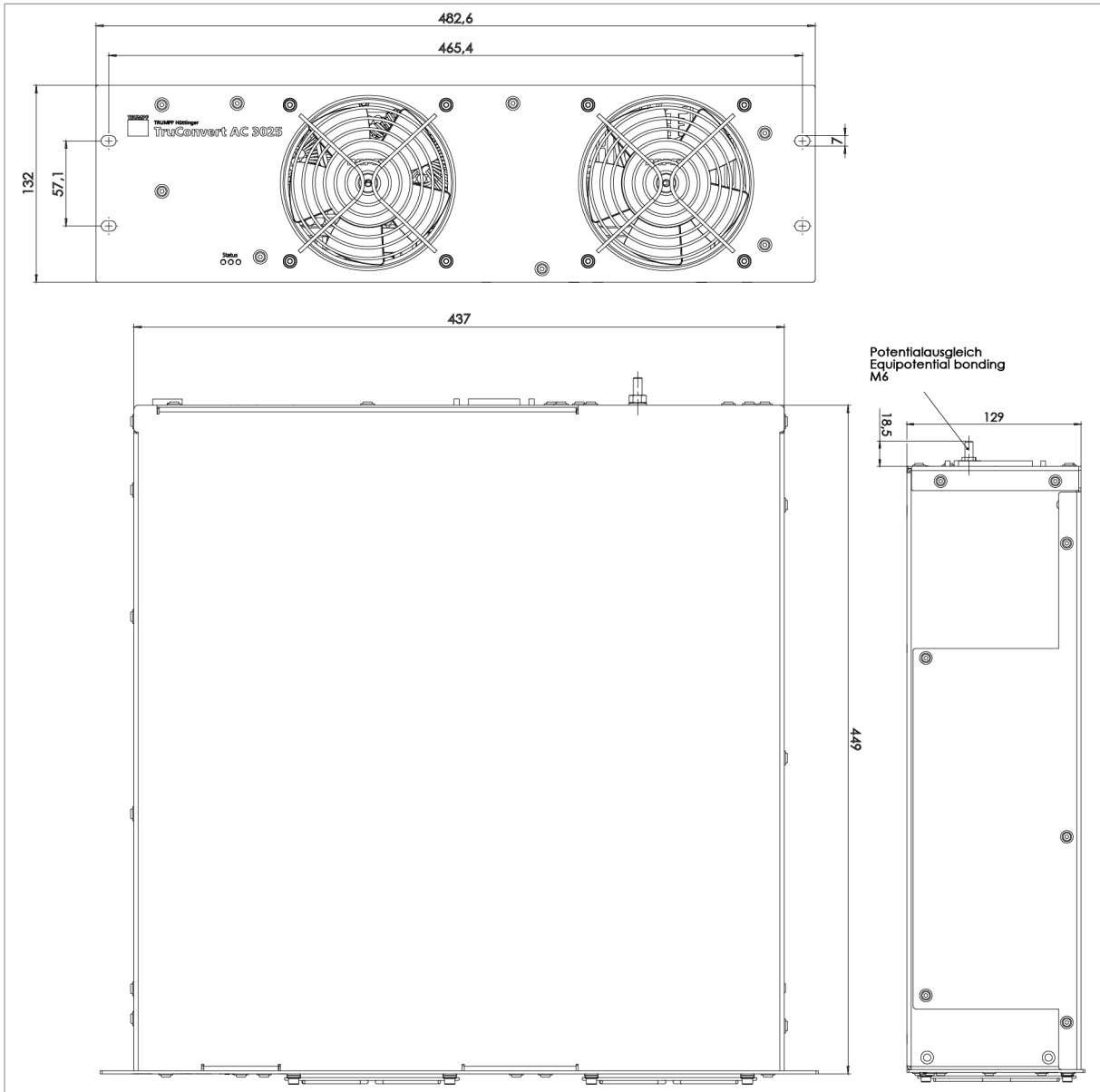

Dimensional drawing

Fig. 12



Environmental conditions

Condition	Temperature	Humidity ⁴	Air pressure	Contamination ⁵
Rated operation ⁶	-5 °C to +40 °C +23 °F to +104 °F	5 ... 90 %	Up to approx. 78 kPa (± 2000 m high above sea level)	Pollution degree 2
Limited power operation	+40 °C to +65 °C +104 °F to +149 °F			
Storage	-20 °C to +80 °C -4 °F to +176 °F	5 ... 90 %		
Transport	-20 °C to +80 °C -4 °F to +176 °F	< 90 %		

Environmental conditions

Tab. 10

3.2 TruConvert System Control data

Interfaces

Description	Value
24 V supply voltage, DC	24 V DC ± 10 % / 250 mA PCB plug connector, 2-pin
Ethernet interface 1	<ul style="list-style-type: none"> ▪ Connection for web-based user interface or Modbus TCP/UDP ▪ RJ-45
RS-485 interface	<ul style="list-style-type: none"> ▪ Connection for TruConvert AC 3025 or TruConvert DC series 1000 ▪ RJ-45
Reset button	Resetting the IP address
Display	3 status LEDs

TruConvert System Control interfaces

Tab. 11

Housing

Description	Value
Dimensions without connectors (W x H x D)	435 mm x 44.5 mm x 219 mm 17.13" x 1.75" x 8.62"
Dimensions of front panel W x H	482 mm x 44.5 mm 19" x 1.75"
Weight	1.6 kg

- 4 No condensation or icing
- 5 Micro-environment complies with IEC 62109-1
- 6 Applies to operation indoors with and without air conditioning.

Housing

Description	Value
Housing material	Body: galvanized sheet steel Front: stainless steel
Protection class	IP 20

Housing data

Tab. 12

Dimensional drawing

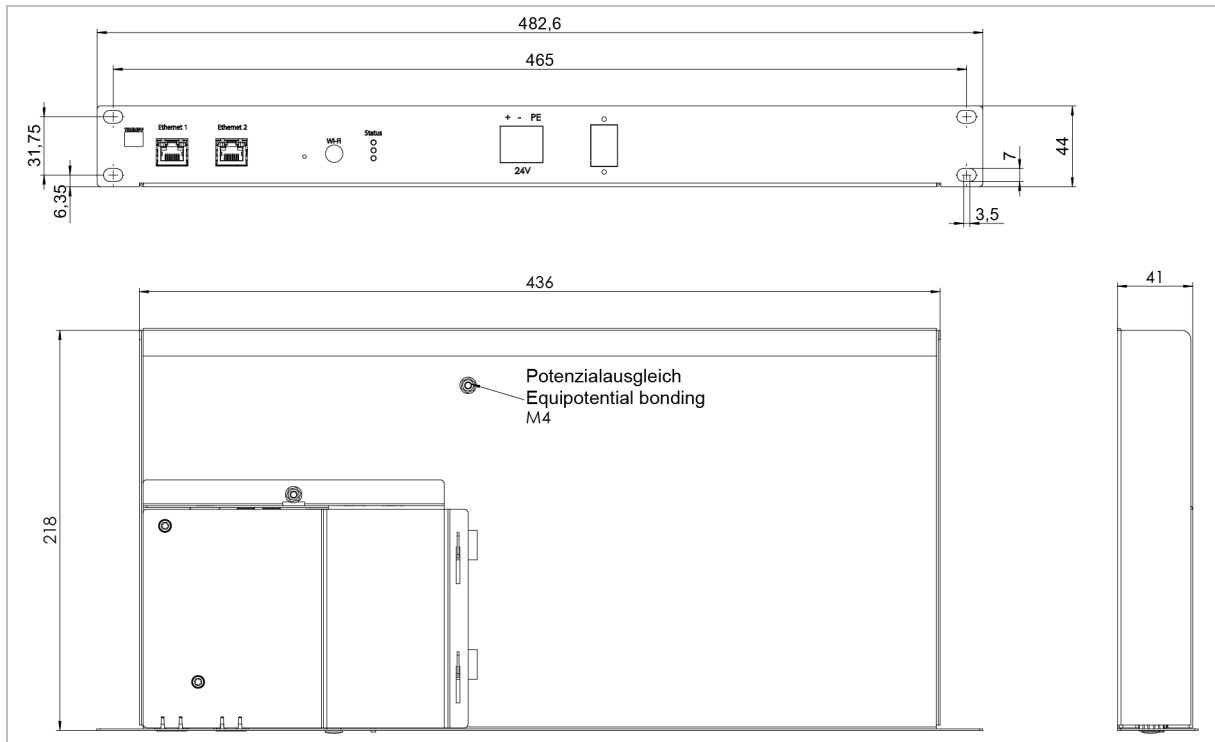

Dimensional drawing

Fig. 13

Environmental conditions

Condition	Temperature	Humidity ⁷	Air pressure	Contamination Micro-environment complies with IEC 62109-1
Operation ⁸	-5 °C to +65 °C 23 °F to +149 °C	5 ... 90 %	Up to approx. 78 kPa	Pollution degree 2
Storage	-20 °C to +80 °C -4 °F to +176 °F	5 ... 90 %	(Δ 2000 m high above sea level)	
Transport	-20 °C to +80 °C -4 °F to +176 °F	< 90 %		

Environmental conditions

Tab. 13

7 No condensation or icing

8 Applies to operation indoors with and without air conditioning.

4. Interfaces

4.1 Mains power connection

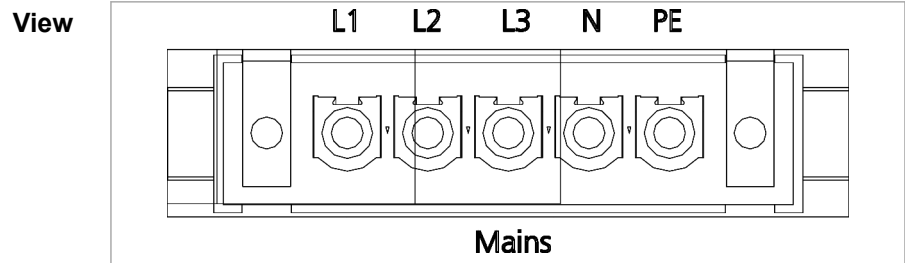

Fig. 14

- Connection**
- On AC 3025 module: Phoenix PCB plug connector
 - Required counterpart: 5-pin connector, 76A, IPC 16/ 5-STF-10, 16
 - Locking mechanism of male connector: Torque: **0.3 Nm**

Cable requirement

	For region EN / IEC	For region UL / CSA
With 50 A external fuse	5 x 10 mm ²	5 x AWG 8
With 40 A external fuse	5 x 6 mm ²	5 x AWG 10

Cable requirement for grid connection

Tab. 14

The information applies to:

- Ambient temperature 30 °C, 86 °F
- Cable operating temperature: 90 °C, 194 °F
- Installation type: Open air
- If the environmental conditions differ from those listed above, contact TRUMPF Service.

4.2 Potential equalization

View

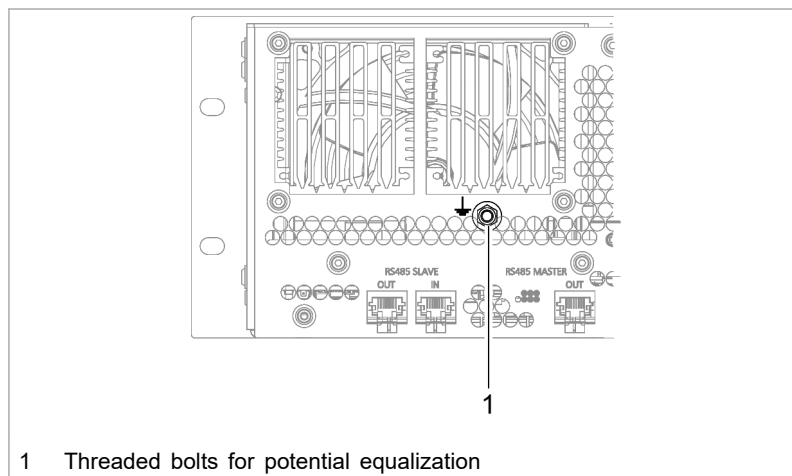

Potential equalization

Fig. 15

Connection ■ M6 threaded bolt, torque: **5 Nm**

Cable requirement ■ 1 x 4 mm² / 1 x AWG 10

4.3 DC link

View

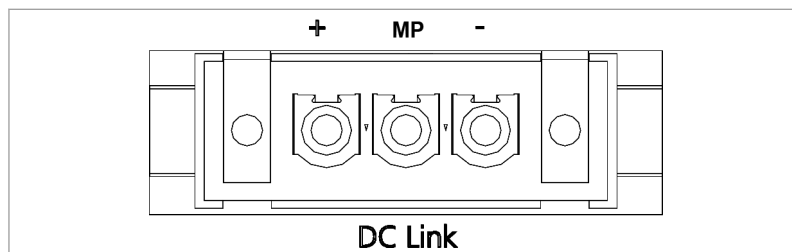
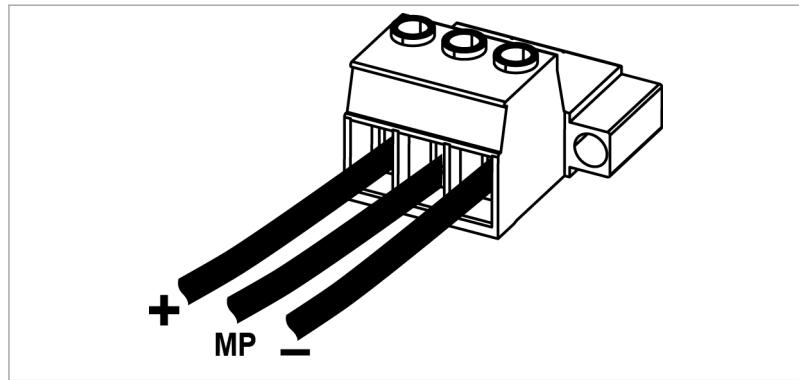

Fig. 16

Connection ■ At the AC-DC module: Phoenix PCB plug connector
 ■ Required counterpart: connector, 3pin, 76 A, IPC 16/ 3-STF-10.16
 ■ Locking mechanism of male connector: Torque: **0.3 Nm**



Connector for DC link voltage

Fig. 17

- Cable requirement**
- For region EN / IEC: 3 x 6 mm²
 - For region UL / CSA: 3 x AWG 10
 - The information applies to:
 - Ambient temperature 30 °C, 86 °F
 - Cable operating temperature: 90 °C, 194 °F
 - Installation type: Open air
 - If the environmental conditions differ from those listed above, contact TRUMPF Service.

Note

To keep inductivity at a minimum cables should be twisted.

4.4 Contactor release contact and mains voltage measurement

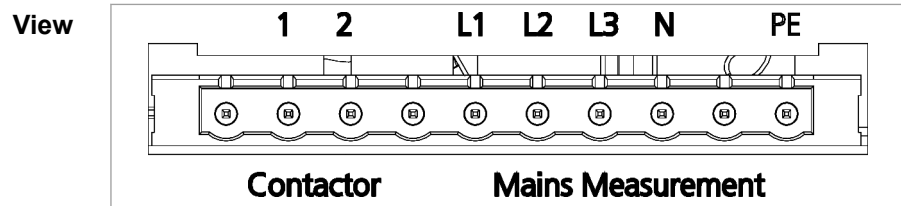

Contactor release contact and mains voltage measurement ("Contactor / Mains Measurement")

Fig. 18

- Connection**
- On AC 3025 module: Phoenix PCB plug connector
 - Required counterpart: 10-pin connector, 16A, GMSTB 2.5 HCV/ 10-ST-7.62-LR
- Cable requirement**
- 10 x 1.5 mm² / 10 x AWG 16

4.5 24 V supply voltage (DC)

NOTICE

Destruction of the device through improper grounding of the 24 V supply voltage source.

The negative terminal of the supply voltage is not connected to PE in the AC-DC module. If the incorrect terminal (positive terminal) of the external 24 V supply voltage source is grounded, the device will be damaged or destroyed.

- If grounding of the external 24 V supply voltage source is performed by the customer: ground the **negative terminal**.

View

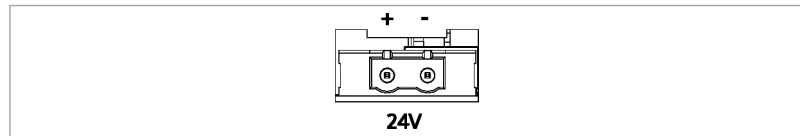

24 V supply voltage (DC)

Fig. 19

Connection

- At the AC-DC module: Phoenix PCB plug connector
- Required counterpart: 2-pin connector, 16A, GMSTB 2.5 HCV/ 2-ST-7.62-LR

Cable requirement

- 2 x 1.5 mm² / 2 x AWG 16

Use

The 24V supply voltage is necessary for supplying the following components of the AC-DC module:

- Control
- Fan
- Driver of power stages

4.6 Communication interfaces

View

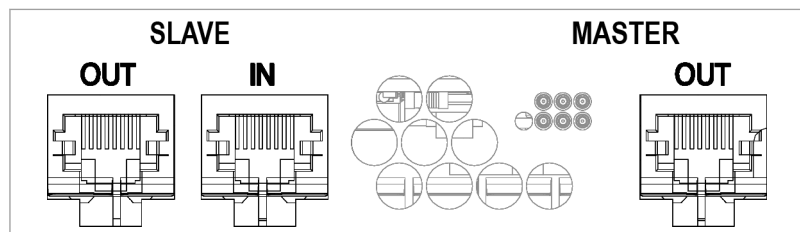

Communication interfaces

Fig. 20

Connection

- RJ-45

- Cable requirement**
- Twisted pair patch cable in accordance with standard TIA/EIA-568A/B
 - CAT 5 or higher
 - Max. length: 30 m

Use The use of the communication interfaces is dependent on the configuration (see "Configurations", pg. 11).

Example Connect system control (RS-485 connection) to the AC-DC module (RS-485 SLAVE IN connection).

Connect the AC-DC module (RS-485 SLAVE OUT connection) to the supplied terminating resistor.

A DC-DC module (RS-485 IN connection) is connected from the AC-DC module (RS-485 MASTER connection).

If further DC-DC modules are operated, the RS-485 OUT connection of the preceding DC-DC module is connected to the RS-485 IN connection of the following DC-DC module.

Notes

- The total length of the data cable from the system control to the last DC-DC module via the AC-DC module must not exceed 30 m.
- If no further DC-DC module is connected to the DC-DC module, the RS-485 OUT connection must be terminated with a terminating resistor.

4.7 Interfaces on the system control

TruConvert System Control These interfaces are located on the system control TruConvert System Control.

24 V supply voltage (DC)

NOTICE

Destruction of the device through improper grounding of the 24 V supply voltage source.

The negative terminal of the supply voltage is not connected to PE in the AC-DC module. If the incorrect terminal (positive terminal) of the external 24 V supply voltage source is grounded, the device will be damaged or destroyed.

- If grounding of the external 24 V supply voltage source is performed by the customer: ground the **negative terminal**.

View

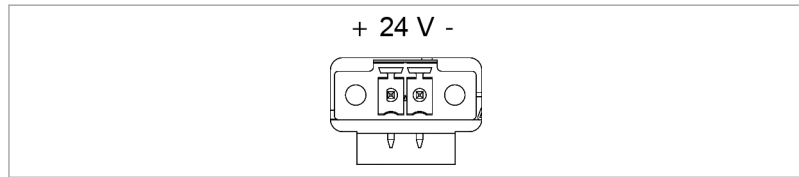

24 V supply voltage (DC)

Fig. 21

Connection

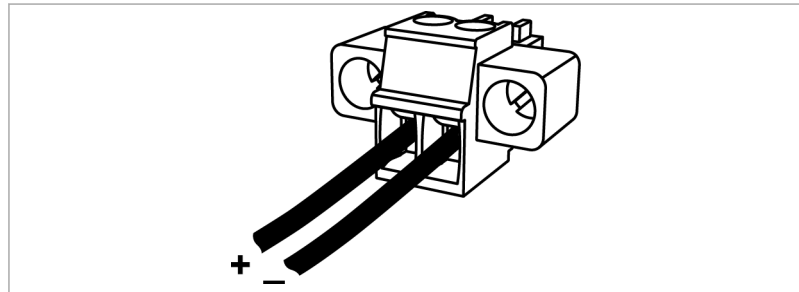

Connector for 24 V supply voltage (DC)

Fig. 22

- On the device: Phoenix PCB plug connector
- Required counterpart: connector, 2-pin, 8A, CS 3.5 mm
- Locking mechanism of male connector: Torque: **0.3 Nm**

Fuse External fuse protection must be provided by the customer.

Ethernet

View

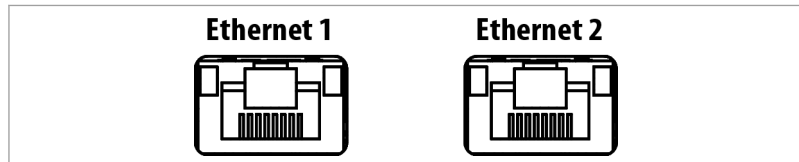

Ethernet data connection

Fig. 23

Connection ▪ RJ-45 male connector

- Cable requirement**
- Twisted pair patch cable in accordance with standard TIA/EIA-568A/B
 - CAT 5 or higher
 - Max. length: 100 m

Note

The total length of the data cable must not exceed 100 m from the PC to the last system control.

RS-485

View

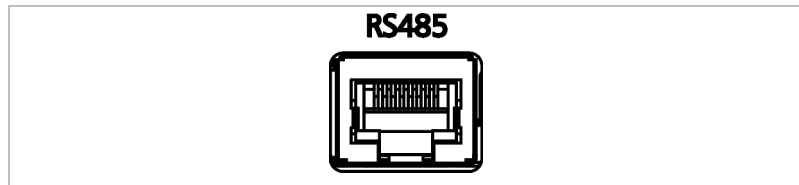

RS-485 data connection

Fig. 24

Connection ■ RJ-45 male connector

Cable requirement ■ Twisted pair patch cable in accordance with standard TIA/EIA-568A/B
■ CAT 5 or higher
■ Max. length: 30 m

Note

The total length of the data cable from the system control to the last DC-DC module via the AC-DC module must not exceed 30 m.

5. Standards and directives

5.1 CE certification

EU directives:

- Low-voltage directive 2014/35/EU
- Electromagnetic compatibility directive 2014/30/EU

Standards taken into account:

- EN 62040-2: 2006/AC class C2
- EN 62109-1:2010
- UL 1741
- IEC 62109-2
- IEC 62477-1

5.2 EU declaration of conformity TruConvert AC 3025

TRUMPF



EU Declaration of Conformity

in accordance with
Low Voltage Directive 2014/35/EU
Directive relating to electromagnetic compatibility 2014/30/EU

We hereby declare that the following device complies with all the relevant requirements of the EU directives listed above.

Device:	TruConvert AC 3025
Serial number:	≥ 204298566
Applied harmonized standards, in particular:	EN 62109-1:2010, EN 62040-2:2006/AC Klasse C2
Party authorized to compile the technical file:	Benedikt Röser

Town / Date / Signature Freiburg im Breisgau, 11.12.2019

Benedikt Röser
Quality Director

TRUMPF Hüttinger GmbH + Co. KG
Bötzinger Straße 80
79111 Freiburg im Breisgau, Germany

Phone +49 (0) 761 8971-0
Fax +49 (0) 761 8971-1150

Info.Elektronik@de.trumpf.com
www.trumpf.com

TE172sc
V 2019 - 11

en

EU declaration of conformity TruConvert AC 3025

Fig. 25



5.3 EU declaration of conformity TruConvert System Control

Class C1 is achieved when the supply lines of the 24 V supply voltage are equipped with the provided ferrite cores. Otherwise class C2 is achieved.



EU Declaration of Conformity

in accordance with
Low Voltage Directive 2014/35/EU
Directive relating to electromagnetic compatibility 2014/30/EU

We hereby declare that the following device complies with all the relevant requirements of the EU directives listed above.

Device:	TruConvert System Control
Serial number:	≥ 203622306
Applied harmonized standards, in particular:	EN 62109-1:2010, EN 62040-2:2006 / AC Klasse C1
Party authorized to compile the technical file:	Benedikt Röser

Town / Date / Signature Freiburg im Breisgau, 10.02.2020

Benedikt Röser
Quality Director

TRUMPF Hüttinger GmbH + Co. KG
Bötzingen Straße 80
79111 Freiburg im Breisgau, Germany

Phone +49 (0) 761 8971-0
Fax +49 (0) 761 8971-1150

Info.Elektronik@de.trumpf.com
www.trumpf.com

TE172sc
V 2019 - 11

en

6. Installation

6.1 Inspecting the delivery

1. Check the device immediately as soon as it is delivered for completeness in accordance with the delivery note and also for visible damages incurred during transport.
2. In order to retain the right of recourse, report any shipping damages immediately in writing to the forwarding agent, the insurance company and TRUMPF.

6.2 Disposing of packaging material

If you do not want to keep the packaging material for a subsequent transport:

- Dispose of all packaging materials in compliance with the relevant regional waste disposal regulations.

6.3 Transport

⚠ CAUTION

Risk of injury due to the weight of the device

- Do not carry or lift the device **alone**.
- Do not use protruding parts to lift the device.
- Lift device using suitable lifting gear.

NOTICE

Damage to impact-sensitive components

If the device is set down heavily or tips over, impact-sensitive components inside the device will be damaged (e.g. fans, circuit boards).

- Do **not** set down the device heavily or drop it.
- Stand the device on its underside or on its side.
- If necessary, secure the device against tipping over.

6.4 Storage conditions

If you do not install the device immediately following delivery:

1. Store the device in original packaging.
2. Ensure that the specified environmental conditions are maintained.

6.5 Requirements for the site

- Installation indoors**
- Operation is permissible in a closed electrical operating room only.
 - Installation, mounting and operation according to **IEC 62109-2**:
 - Access restriction for the electrical operating room.
 - Only electrically instructed persons may work within the operating room.
 - If the specified operating conditions for TruConvert AC 3025 are observed, it is permissible to forgo residual current devices (RCD) unless country-specific requirements state otherwise.

If necessary, post a notice at the electrical operating room indicating that these are not present.
 - According to **IEC 62477-1**, installation, mounting and operation are only permissible in:
 - Non-flammable environment.
 - Indoors with air conditioning.

Air intake and air outlet Sufficient space must be present for air intake and air outlet in order to ensure adequate cooling of the device.

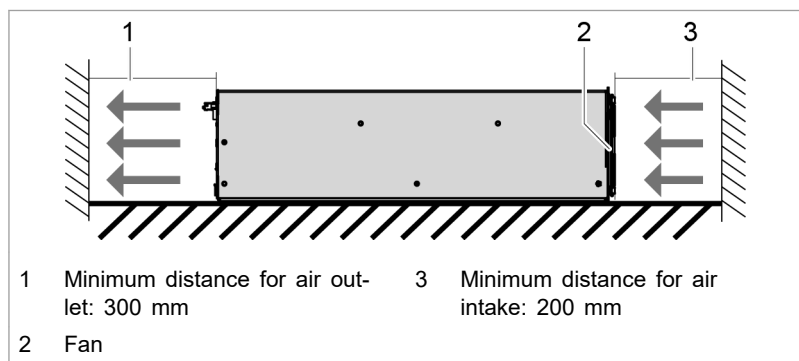

Air circulation intervals

Fig. 27

Maximum back pressure Sufficient cooling of the module is only ensured if a sufficient air flow rate up to a maximum permissible back pressure is provided.

In addition, note that the air flow rate must be multiplied by the number of devices if several modules are operated.

Air short circuits and mutual interference of the modules must be prevented.

Number of modules	Air flow rate	Maximum back pressure in the air duct
1	400 m³/h	20 Pa
n	n x 400 m³/h	20 Pa

Maximum back pressure

Tab. 15

- Mains separation device** Access to the external mains separation device must not be obstructed by the device.
- Fuses** Fuses must be provided on-site by the customer (see ["Grid connection data"](#), pg. 17).
- Residual current device** If a TruConvert AC3025 is or multiple devices are operated together with a DC-coupled PV system that is not electrically isolated, a suitable residual current device must be installed depending on the installation location of the system.
- Observe all country-specific requirements regarding location and installation.
 - Install a **type B** residual current device (RCD or similar).
 - Maximum permissible continuous residual current (IEC 62109-2:2011 Sec.4.8.3.5):
 - Single installation: 300 mA.
 - Multiple installation within a system: 10 mA per 1 kVA nominal output power.
 - Separation time of outer conductors and/or neutral conductor: 0.3 s.
 - Determine the rated current specifications corresponding to the system layout.
 - Set up the residual current devices in accordance with the country-specific grid frequencies and grid voltages.
- Ground fault and leakage current monitoring**
- The TruConvert AC 3025 device does not have any integrated ground fault or residual current monitoring.
 - If the device is used in a battery energy storage system (BESS), the technical specifications of the system integrator and of the respective system manual with respect to ground fault and leakage current monitoring must be observed.
- Dependent safety requirements** The TruConvert AC 3025 device is a transformerless inverter:
- Without internal voltage isolation.
 - Without integrated, automatic separation device.
 - Without integrated residual current device.
- The implementation of, compliance with and monitoring of the dependent safety requirements lies solely and completely with the responsible system operator or a third party commissioned by the system operator (see ["Connection diagram"](#), pg. 44).

6.6 Electrical connection

⚠ DANGER

Connection cables carry life threatening voltage!

- Do not work under voltage.
- Before connecting, check mains cables to ensure that they are not electrically live.
- Before connecting, check DC link (DC Link) voltage cables to ensure that they are not electrically live.

⚠ DANGER

Danger of fire!

- Observe the installation regulations of the installation site.
- Fuse the DC link connection (DC Link) according to the specifications (see "DC link", pg. 19).
- The following applies to UL-bound countries: The "National Electrical Code, ANSI/NFPA 70" wiring methods are to be used.

NOTICE

Failure to observe the torques can damage the AC-DC module!

- Note torques when screwing.

NOTICE

Observe regional requirements for the grid connection!

- The following applies to UL-bound countries: The "National Electrical Code, ANSI/NFPA 70" wiring methods are to be used.

Establishing electrical connection

Condition

- Components to be provided by the customer are installed (see "Connection diagram", pg. 44).

Means, Tools, Materials

- Terminating resistor for the data output (provided).
- Male connector (provided):
 - Connector "Mains", 5-pin
 - Connector "Contactor / Mains Measurement", 10-pin
 - Connector "DC Link", 3-pin
 - Connector "24V", 2-pin

Note

Observe regional requirements for the grid connection!

The regional requirements must be clarified at the customer's location with the mains operator before the device is connected and commissioned.

Connect mains supply

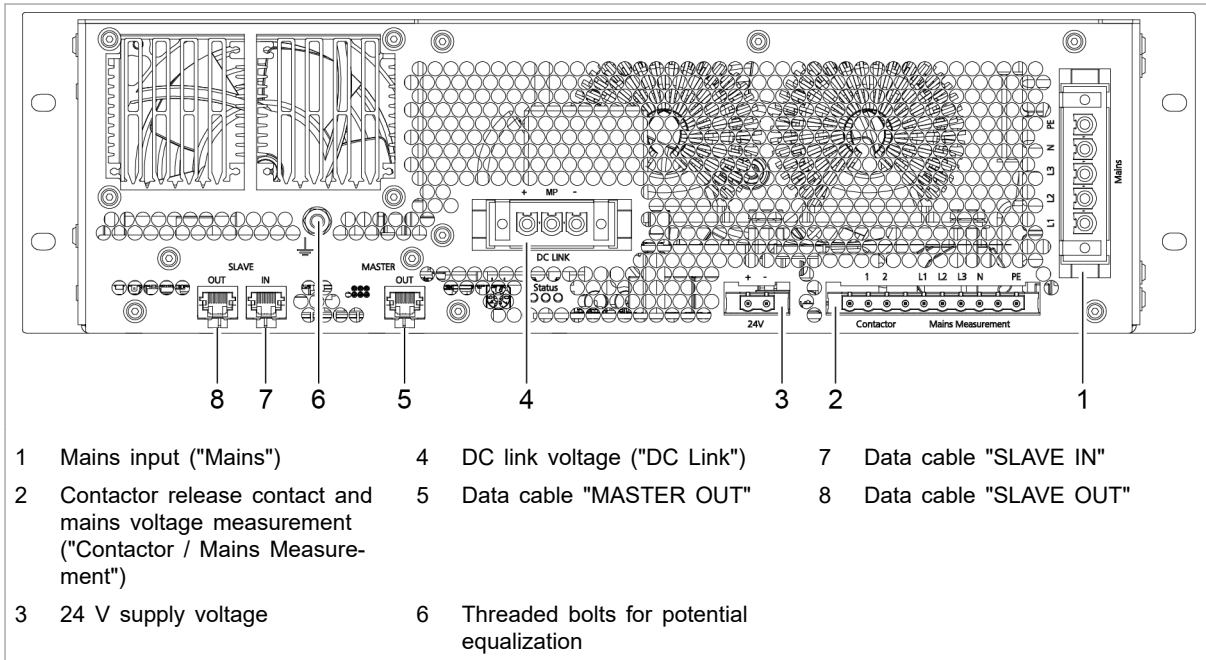

Connection points

Fig. 28

Note

Required rotating field: clockwise. Maintain correct phase sequence: L1, L2, L3.

1. Attach the 5-pin connector to the 5-wire mains cable. Assignment (see "Mains power connection", pg. 27).
2. Plug male connector into "Mains" (1).

Screw the connector securely to the flange using the two screws.

The device is connected to the 3 phases, the neutral conductor and the protective earth (PE).

Connect mains synchronization and contactor release contact

3. Attach the 10-pin connector to the lines for the contactor release contact, mains voltage measurement and PE. Assignment (see "Contactor release contact and mains voltage measurement", pg. 29).
4. Plug male connector into "Contactor Mains Measurement" (2).

Make sure that the automatic locking mechanism engages.

Connect 24 V supply voltage

NOTICE

Destruction of the device through improper grounding of the 24 V supply voltage source.

The negative terminal of the supply voltage is not connected to PE in the AC-DC module. If the incorrect terminal (positive terminal) of the external 24 V supply voltage source is grounded, the device will be damaged or destroyed.

- If grounding of the external 24 V supply voltage source is performed by the customer: ground the **negative terminal**.

5. Mount 2-pin connector on 24 V cable. Assignment (see "24 V supply voltage (DC)", pg. 30).
6. Plug male connector into "24V" (3).
Make sure that the automatic locking mechanism engages.
7. Switch on 24 V supply voltage on the AC-DC module.

Connecting DC link

If photovoltaic modules are connected to the DC link:

- Connection permissible only via a string optimizer approved by TRUMPF.
- Only use photovoltaic modules and string optimizers that may be used together.
- Observe the reverse current stability of the photovoltaic modules (see "PV input variables", pg. 21).

⚠ DANGER

Connection cables carry life-threatening voltage.

- Do not work under voltage.
- Before connecting, check DC link voltage cables to ensure that they are not electrically live.

Connecting potential equalization to AC-DC module

8. Mounting 3-pin male connectors on DC link cables:
 - DC+ and DC-.
 - Neutral point MP of the DC link, if present (optional).
 - Assignment (see "DC link", pg. 28).
9. Plug male connector into "DC Link" (4).
Screw the connector securely to the flange using the two screws.
10. Optionally, a potential equalization conductor can be screwed onto the potential equalization bolt (6). Max. torque: 5 Nm.

Connecting protective earth to system control

11. Screw protective earth on TruConvert System Control. Max. torque: 2 Nm.

Connecting data cable

12. Connect data connection "RS-485" of the TruConvert System Control with data input "SLAVE IN"(7) of the AC-DC module.
13. Either
 - Connect the terminating resistor to the "SLAVE OUT"(8) data output of the AC-DC module.

or

 - Connect the "SLAVE OUT" data output (8) to the "SLAVE IN" data input (7) of the next AC-DC module.
14. Connect the data output "MASTER OUT" (5) of the AC-DC module to the data input of the DC-DC module.
15. Connect the TruConvert System Control to the master (Modbus master or PC with web browser)

Connecting 24 V supply voltage to system control

16. Connect and switch on 24 V supply voltage to TruConvert System Control.

If the system control does not recognize the AC-DC module:

- For the system control to detect the AC-DC module, first supply 24 V to the AC-DC module and then to the system control.
- Alternatively, simultaneously apply the 24 V supply voltage to the system control and to the AC-DC module.

LED1 (green) flashes and shows that the AC-DC module is operational (see "Display elements", pg. 16).

Connection diagram

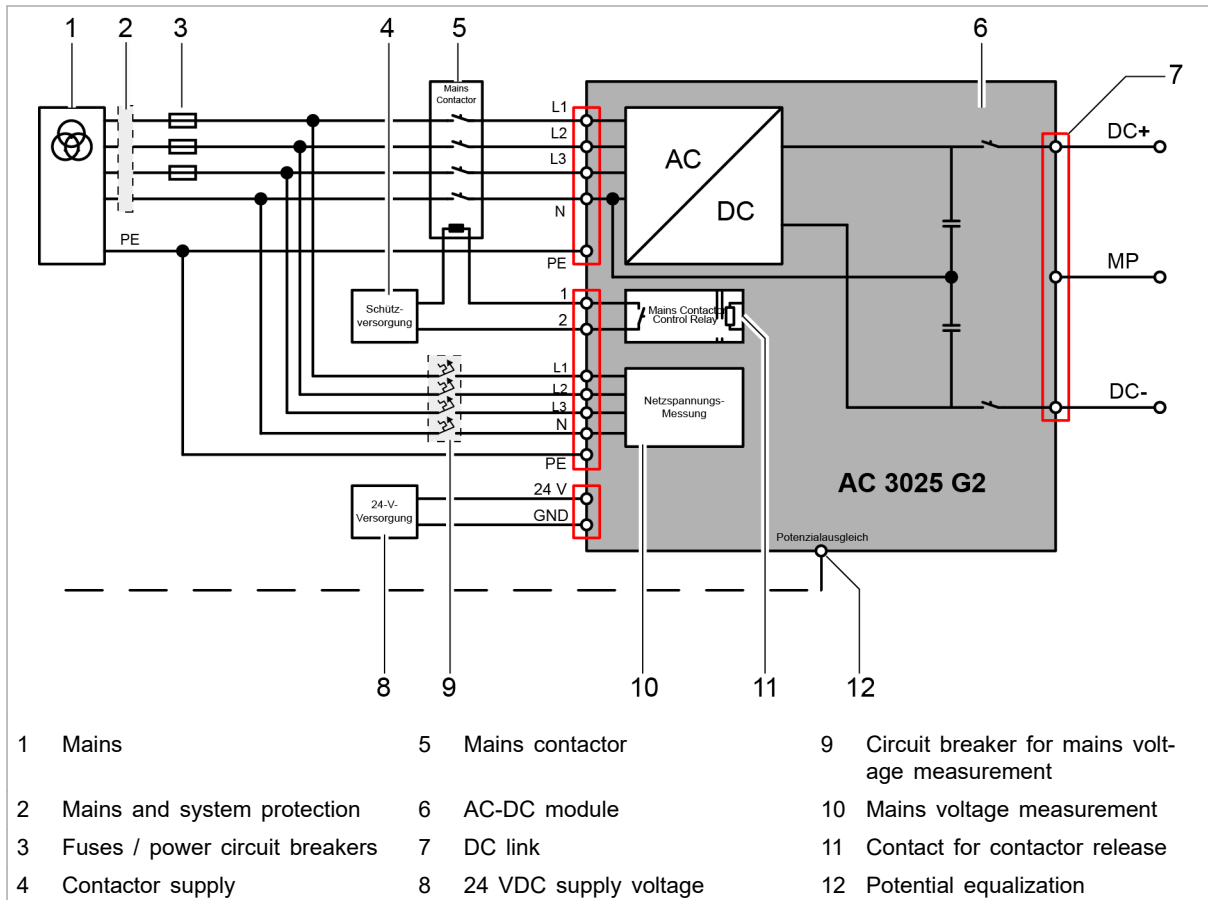

Electrical connection

Fig. 29

Customer area

The following components are not part of the AC-DC module, but must rather be provided by the customer:

- Australia and New Zealand: Observe the special requirements regarding installation (see ["Connection according to AS/NZS 4777.2"](#), pg. 53).
- Mains and system protection (2)
(If residual current devices are used: use type B.)
- Fuses / power circuit breakers (3)
(see ["Grid connection data"](#), pg. 17)
- Mains contactor (5)
 - Dielectric strength corresponding to mains voltage: 400 / 480 V \pm 10%
 - Current-carrying capacity: 64 A
 - Operation mode: AC-3
- 24 VDC supply voltage (8)
(see ["Entire device"](#), pg. 17)

- Contactor supply (4)
 - Is switched via device-internal switching contact (11).
 - Permissible operational data for switching contact: 24 – 60 VDC, 5 A or 85 – 277 VAC, 5 A.
 - The 24 VDC supply voltage can be used to supply the mains contactor if necessary if voltage and power are sufficient.
- Circuit breaker for mains voltage measurement (9)
(see "Interfaces", pg. 22)
- Connection of energy sources to the DC link (7)
Observe the country-specific requirements regarding the installation of external mains separation devices.

Note

Observe regional requirements for the mains connection!

The regional requirements must be clarified at the customer's location with the mains operator before the device is connected and commissioned.

Connection acc. to IEC 62109-2

Single-fault protection

Single-fault protection between PV system and AC mains

The device has internal, simple basic insulation. To satisfy the requirements of IEC 62109-2 for the protection of the operating staff, an external, monitored, automatic separation device is also required. This external separation device is to be installed by the customer.

This combination of internal basic insulation and external separation device guarantees at a minimum in the single-fault case that the basic insulation or a simple, mechanical interruption between the AC supply network and the PV system exists.

The implementation of the basic insulation in the device is based on the specifications of IEC 62109-1.

Implementation of the single-fault protection

All automatic separation devices are also to be monitored.

The electrical or electronic fault indication can be accessed and evaluated remotely.

Recommendation: Monitor separation devices via mechanical, positive-opening auxiliary contacts at the respective separation device. Depending on the design of the used contactors, the mechanical, positive-opening auxiliary contacts may already be integrated in the contactor or can be mounted retroactively.

Due to the different amount of installation work required, the appropriate implementation variant is recommended for a low number of devices (A, B) or a large number of devices (C).

Depending on the number of devices used, one or the other implementation variant is to be recommended, as the amount of work associated with the installation differs.

Variant	Protection 1	Protection 2	Conductor system	Number of devices
A	Internal basic insulation	4-pin mains contactor	5-conductor system (L1, L2, L3, N, PE)	Up to 4
B	Internal basic insulation	1 monitored section switch	4-conductor system (L1, L2, L3, PEN) 5-conductor system (L1, L2, L3, N, PE)	Up to 4
C	1 monitored section switch	1 monitored section switch	4-conductor system (L1, L2, L3, PEN)	5 to 16

Condition for variant C: The two section switches are inserted before separation of the PEN conductor into PE and N.

Possible implementation variants of the single-fault protection Tab. 16

Examples: External separation devices and auxiliary switch modules

Component	Example
Mains contactor, 4-pin	EATON DIL M125
Auxiliary switch module	EATON DILM1000-XHI11-SI
Coupling switch (mains contactor, 3-pin)	EATON DILM 1000

Examples for external separation devices and auxiliary switch modules Tab. 17

Auxiliary switch modules must meet the following normative requirements:

- Positive-opening contacts are designed in accordance with IEC/EN 60947-5-1.
- General use in accordance with IEC/EN 60947.
- For use in U.S. or Canadian territories, corresponding UL and/or CSA verification is to be provided.

Peripheral evaluation of the monitoring

The evaluation of the monitoring of the external separation devices as well as the direct display of a fault caused by the separation devices is performed neither by the TruConvert system control nor by the TruConvert AC 3025.

In order to depict the various fields of use of the TruConvert system, the necessary unit for evaluating the monitoring and for fault indication is to be individually tailored to the respective system by the responsible system operator.

Requirements on the evaluation of the monitoring elements:

- The basic insulation of the external separation devices is checked each time before connecting the TruConvert AC 3025 to AC mains.
This prevents one or more contacts of the mains contactor from bridging one of the two basic insulations between the AC mains and the PV system.
- In the event of a fault at one of the external separation devices, the monitoring unit prevents TruConvert AC 3025 from being connected between the PV system and the identical AC grid connection point.
- TruConvert AC 3025 cannot be reconnected until after troubleshooting and subsequent active acknowledgment of the fault.
- Monitoring unit at the place of TruConvert AC 3025 installation triggers an optical or acoustic warning signal for the duration of the error state until active acknowledgment.
 - The warning signal is uniquely assigned to the error state of one or more separation devices.
 - A separate warning signal for each individual separation device is not necessary.
 - The display unit may be installed outside of the electrical operating room in which the TruConvert AC 3025 are installed.

Examples: Monitoring evaluation

Component	Example
Safety relay, certified according to EN 60204-1	EATON ESR5-NO-31-24VAC-DC
Elements for optical or acoustic fault indication	–
Elements for fault acknowledgment	–

Examples: Monitoring evaluation

Tab. 18

Detection of stuck mains contactors

If the switching contacts of a mains contactor that is connected upstream of the AC-DC module are stuck, the AC mains voltage is directly at the unsynchronized AC output of the AC-DC module. This results in an alarm message at the affected AC-DC module. The AC-DC module cannot be operated again until the cause has been rectified and the alarm message has been reset.

Alarm messages that are displayed in the event of a stuck mains contactor
(example with AC-DC module = slave 2 and phase = L2):

- Code: 50006, Source: SLAVE 2
Param: 0 ACDC module → Current → Overcurrent L2
- Code: 50019, Source: SLAVE 2
Param: 0 ACDC module → HW → Overcurrent L2 hardware
- Code: 50094, Source: SLAVE 2
Param: 0 ACDC module → HW → ACDC module alarm

Note

The connection of additional AC-DC modules that are connected in parallel must be prevented by the peripheral monitoring unit, the hierarchically higher-level battery management system (BMS) or the energy management system (EMS). This must be implemented by the system operator.

Connection of photovoltaic power generation units (PV systems)**⚠ WARNING****Dangerous voltage on DC link cables!**

If the sun shines on the PV modules, the DC link cables are under voltage.

- Open the DC separation device between DC link and PV system or battery.
- Secure against reenergizing.
- Comply with the valid safety and accident-prevention laws of the country and of the region.

Requirements for connecting PV systems:

- PV modules must satisfy the requirements of Class A acc. to IEC 61730.
- PV string optimizer must be connected between the PV system and the DC link.
 - The PV systems must not be connected directly to the DC link of the AC-DC module.
 - The used PV string optimizers must be approved by TRUMPF.
 - Installation notes, regulations and operating parameters of the used PV string optimizer must be observed and complied with.
- A protection device that protects against continuous residual currents must be installed.
 - In grounded or ungrounded photovoltaic power generation systems with and without additional battery storage, continuous residual currents can pose a risk of fire in conductive system parts that are not intended for the flow of current.
 - In combination with the non-isolated version of the AC-DC module, continuous DC-side ground faults can result in the destruction of the device and void the warranty.
- All safety requirements specified in IEC 62109-1 and IEC 62109-2 are to be complied with for the operation of a Tru-Convert system on a PV system.

Implementation of the connection to PV systems

Residual current monitoring acc. to IEC 62109-2 can be implemented with an AC/DC sensitive residual current monitoring system of type B ⁹

Example: AC/DC sensitive residual current monitoring system

An AC/DC sensitive residual current monitoring system can be implemented by combining a monitoring unit and a suitable current sensor.

Component	Example
Monitoring unit	Bender RCMS460
Current sensor	Bender CTUB102/CTBC60

Example: AC/DC sensitive residual current monitoring system Tab. 19

Special features of this example:

- Unlike residual current devices (RCD), the residual current monitoring system (RCMS) shown here does not cause a direct, automatic shutdown of the monitored circuit according to DIN VDE 0100 or IEC 60364.
- The suggested RCMS460 monitoring unit monitors the current flow and can, via the two relays on the central coupling switch, cause the inverter system or the entire system to disconnect.
 - Use relay with contact data acc. to IEC 60947-5-1.
- TT- and TN-S systems: The RCMS460 monitoring unit and the CTUB102/CTBC60 current sensor are intended for the approved use in TT- and TN-S systems.
- IT systems: The suggested combination is not permissible here.

Please contact TRUMPF to obtain more detailed information on the implementation possibilities.

Connection and settings of the RCMS460 monitoring unit:

- Integrate in the safety circuit to cause the external mains separation device to switch off in the event of a fault: relay contacts K1, K2.
- In the main menu of the RCMS460 monitoring unit, set:
 - Response value I(dn).
The size of the response value is determined by the continuous output power in kVA that is to be monitored. The response value may be increased by 10 mA for each kVA of the nominal output power.
 - Type of measuring current converter
For the current sensor CTUB102/CTBC60 used in the example: Type AB.
- Further, system-specific settings on the Bender RCMS460 can be found in the manufacturer documentation.

⁹ Type B acc. to IEC 60755 for the monitoring of alternating currents, pulsating and smooth DC residual currents.

Connection diagram for variant A: recommended for up to 4 TruConvert AC 3025

For economic reasons, connection variant A is recommended for 1 to 4 TruConvert AC 3025 units in grouped systems up to a combined total power of 100 kVA. Here, double the basic insulation is used. This insulation consists of the monitored 4-pin mains contactors and basic insulation within the AC-DC modules.

In principle, connection variant A can also be implemented for up to 16 AC-DC modules.

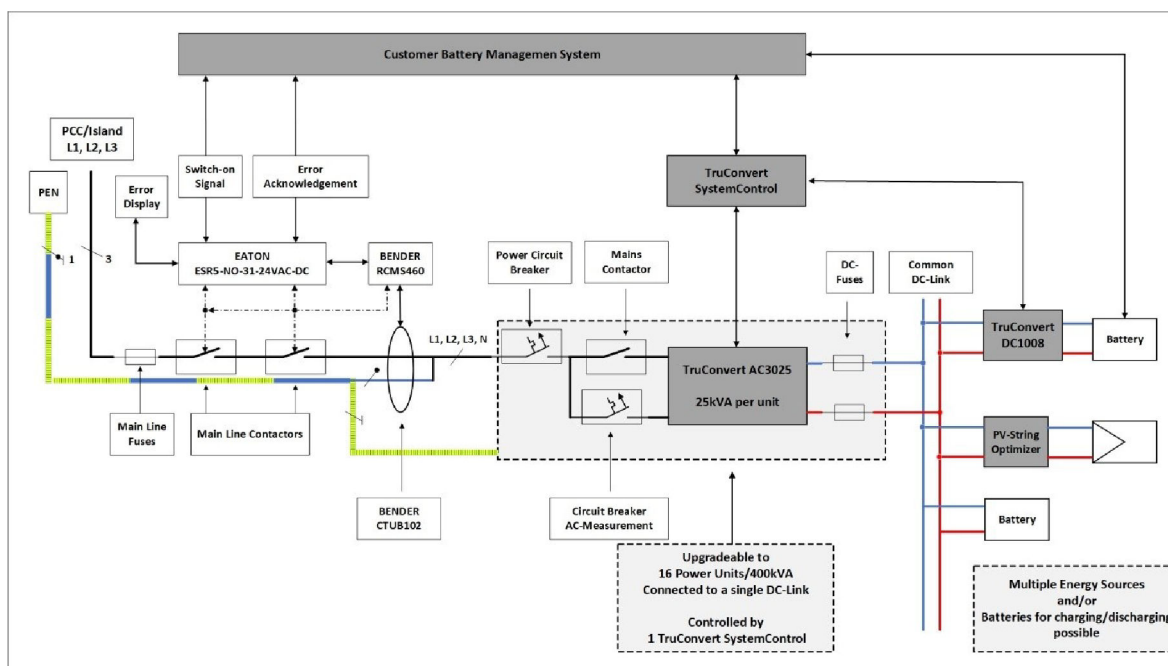

Connection diagram for variant A: recommended for up to 4 TruConvert AC 3025

Fig. 30

The block diagram contains all elements relevant to safety:

- Residual current monitoring system
 - Current sensor
 - Monitoring unit
- Double basic insulation
 - Monitored mains contactor
 - Permanent, simple basic insulation within the TruConvert AC 3025 implemented in the layout
- Devices for fault indication and release

Connection diagram for variant C: recommended for 5 to 16 TruConvert AC 3025

For grouped systems with 5 to 16 AC-DC modules (up to a combined total power of 400 kVA), connection variant C is recom-

mended for economic reasons. Here, two monitored section switches are used.

Connection variant C can, in principle, also be implemented for 1 to 4 AC-DC modules.

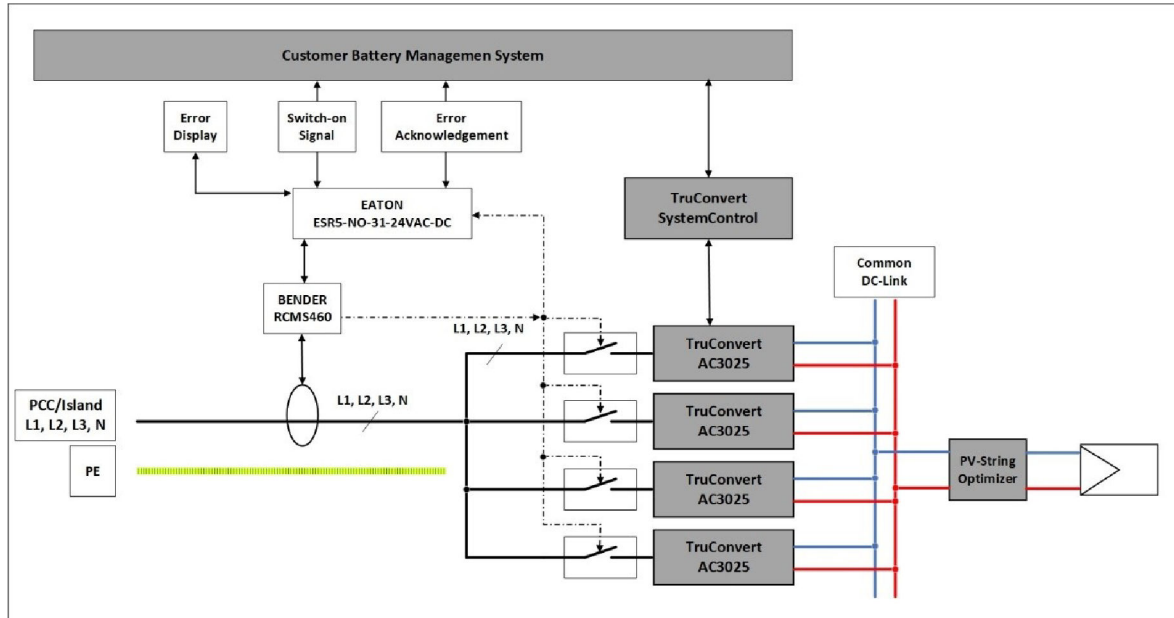

Connection diagram for variant C: recommended for 5 to 16 TruConvert AC 3025

Fig. 31

The figure shows the block diagram of a possible complete system including the connection possibility to the public low-voltage grid (PCC: Point of CommonCoupling) or via the same connection possibilities in isolated operating mode.

There is no explicit switch-over and synchronization unit shown for the transition from grid-tied operation to island operation.

An automatic change between grid-tied to island operation is permissible only in compliance with the country-specific regulations.

Example: Recommended components and cross sections for a 400 kVA system

In the following, components and cross sections for a 400 kVA system consisting of 16 TruConvert AC 3025 are recommended.

In the figure (see "Fig. 32", pg. 52), each gray block corresponds to a 100 kVA unit, which in turn consists of 4 TruConvert AC 3025. Described in the first block from above are the fuse and power components that are specified for each of the used 16 TruConvert AC 3025.

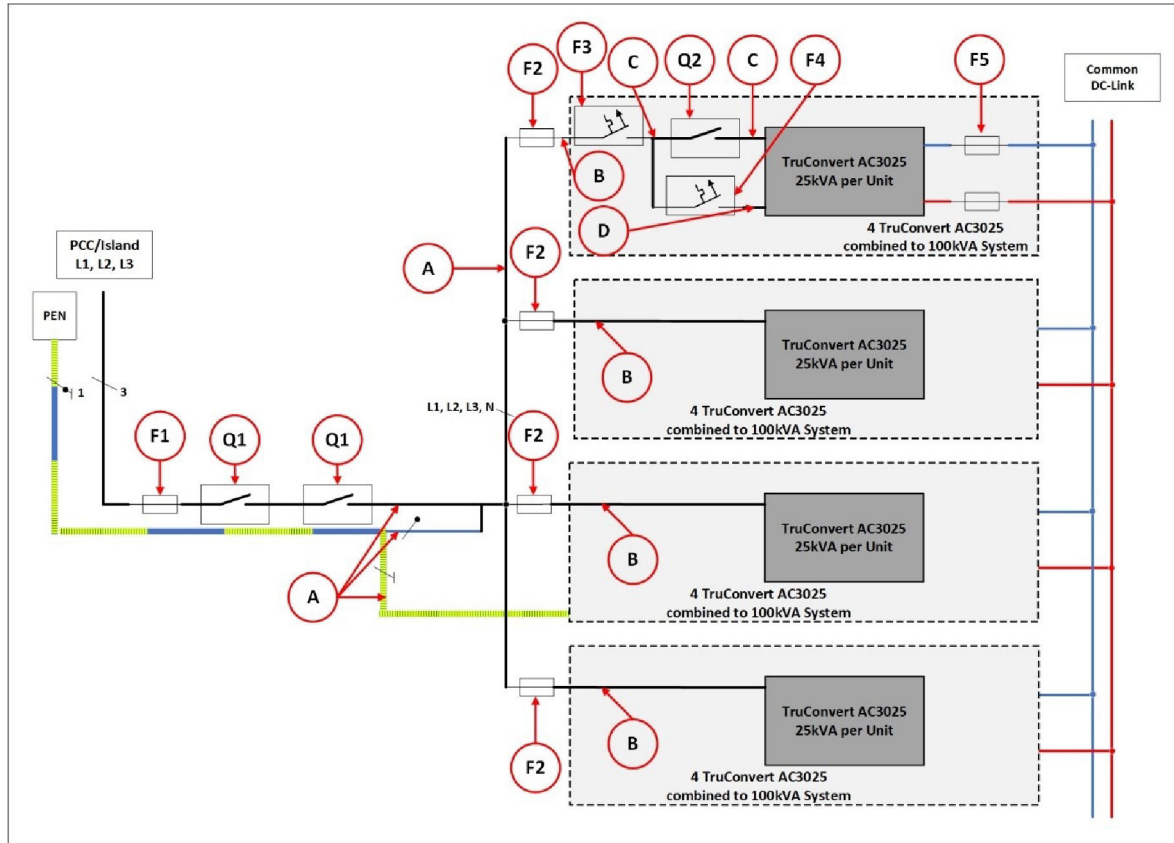

Overview of fuse and power components for a 400 kVA system

Fig. 32

	Meaning	Number	Design
Shown in: (see "Fig. 32", pg. 52)			
A	Cross section	–	EN / IEC: 1000 A busbar 5 x 800 mm ² (L1, 2, 3, N, PE) UL / CSA: 1000 A busbar 5 x 1.24 mm ² (L1, 2, 3, N, PE)
B	Cross section	–	EN / IEC: 200 A busbar 5 x 75 mm ² (L1, 2, 3, N, PE) UL / CSA: 200 A busbar 5 x 0.12 in ² (L1, 2, 3, N, PE)
C	Cross section	–	EN / IEC: 50 A cable 5 x 10 mm ² (L1, 2, 3, N, PE) UL / CSA: 50 A cable 5 x AWG 6 (L1, 2, 3, N, PE)
D	Cross section	–	EN / IEC: cable 5 x 1 mm ² (L1, 2, 3, N, PE) UL / CSA: cable 5 x AWG 16 (L1, 2, 3, N, PE)
Q1	Contactar	2	EATON DIL M1000/22(RA250) / AC3
Q1	Auxiliary switch module	2	EATON DIL M820-XHI11-SI
Q2	Contactar	16	EATON DIL MP125(RDC24) / AC3
Q2	Auxiliary switch module	16	EATON DIL M1000-XHI11-SI
F1	Fuse	1	NH4 1000 A 3-pin Class gG IEC60269-1 500V
F2	Fuse	4	NH1 250 A 3-pin Class gG IEC60269-1 500V
F3	Power circuit breaker	16	EATON FAZ-C50/4 Circuit breaker 3-pin 50 A 15 kA breaking capacity Class D 480 V IEC60947-2

	Meaning	Number	Design
F4	Power circuit breaker	16	EATON FAZ-C1/4 Circuit breaker 4-pin 1 A 15 kA breaking capacity Class D 480 V IEC60947-2
F5	Fuse	32	NH1 EATON Bussmann PV-63A
Shown in: (see "Fig. 31", pg. 51)			
	Monitoring unit	1	BENDER RCMS460
	Current sensor	1	BENDER CTUB102/CTBC60
	Monitoring evaluation	1	EATON ESR5-NO-31-24VAC-DC

Tab. 20

Connection according to AS/NZS 4777.2

This chapter describes additional country-specific installation requirements for Australia and New Zealand.

Multiple-mode inverter

The multiple-mode inverter can switch between 2 modes: grid-tied mode and stand-alone mode in island operation.

The nominal values and connecting elements specified in this chapter (see "Connection according to AS/NZS 4777.2", pg. 53) apply to AC-DC modules that are used as multiple-mode inverters.

For electrical installation, the following points must be observed:

- The external load separation device disconnects **only** the three active conductors (L1,L2, L3). The neutral conductor is not interrupted.
- It must be possible to secure the main switch or the main contactor against being switched on again.
- Dimension the overcurrent protection according to the technical specification (see "Grid connection data", pg. 17).
- Before switching over to stand-alone mode, the system operator must disconnect the energy storage system including inverter from the grid.

In stand-alone mode, the "Grid-interactive port" is used as the stand-alone connection.

- The TruConvert AC 3025 device does not have any integrated ground fault or residual current monitoring.
If the device is used in a battery energy storage system (BESS), an external unit for monitoring ground faults must be installed. This external unit must meet the requirements specified in AS/NZS 5139.

Demand response mode (DRM)

Function description "Demand response mode"

For installation of the TruConvert AC3025 in grid-tied energy storage systems in Australia, the implementation of "Demand Response Mode 0" (DRM 0) is obligatory.

The activation of DRM 0 mode triggers the mains separation device. Depending on the version of the energy storage system, the mains separation device may be activated at system level (main connection point) or individually for each inverter (integrated load separation device).

The responsible local distribution network operator sends the signal that activates DRM 0 mode.

A "Demand Response Enabling Device" (DRED) as receiver device must be integrated in the system. The DRED forwards the signal to the DRM 0 device TruConvert DRM-0 Device. The DRM 0 device sends the signal to the inverter and the integrated load separation device.

The system operator must ensure the prioritization of the DRM 0 command in conjunction with the requirements from table 2.6 AS/NZS 4777.2:2020.

After the DRM 0 command has been received, the AC-DC module is disconnected from the grid. If the DRED withdraws the DRM 0 command, the errors must first be reset at the AC-DC module and the AC-DC module must then be restarted. The AC-DC module does not reconnect to the grid automatically.

On request, TRUMPF can provide further information on the TruConvert DRM-0 Device.

DRM designation

On the TruConvert DRM-0 Device, a sign (8) indicates which mode of the "demand response mode" is supported (see "Fig. 33", pg. 55).

View of TruConvert DRM 0 device

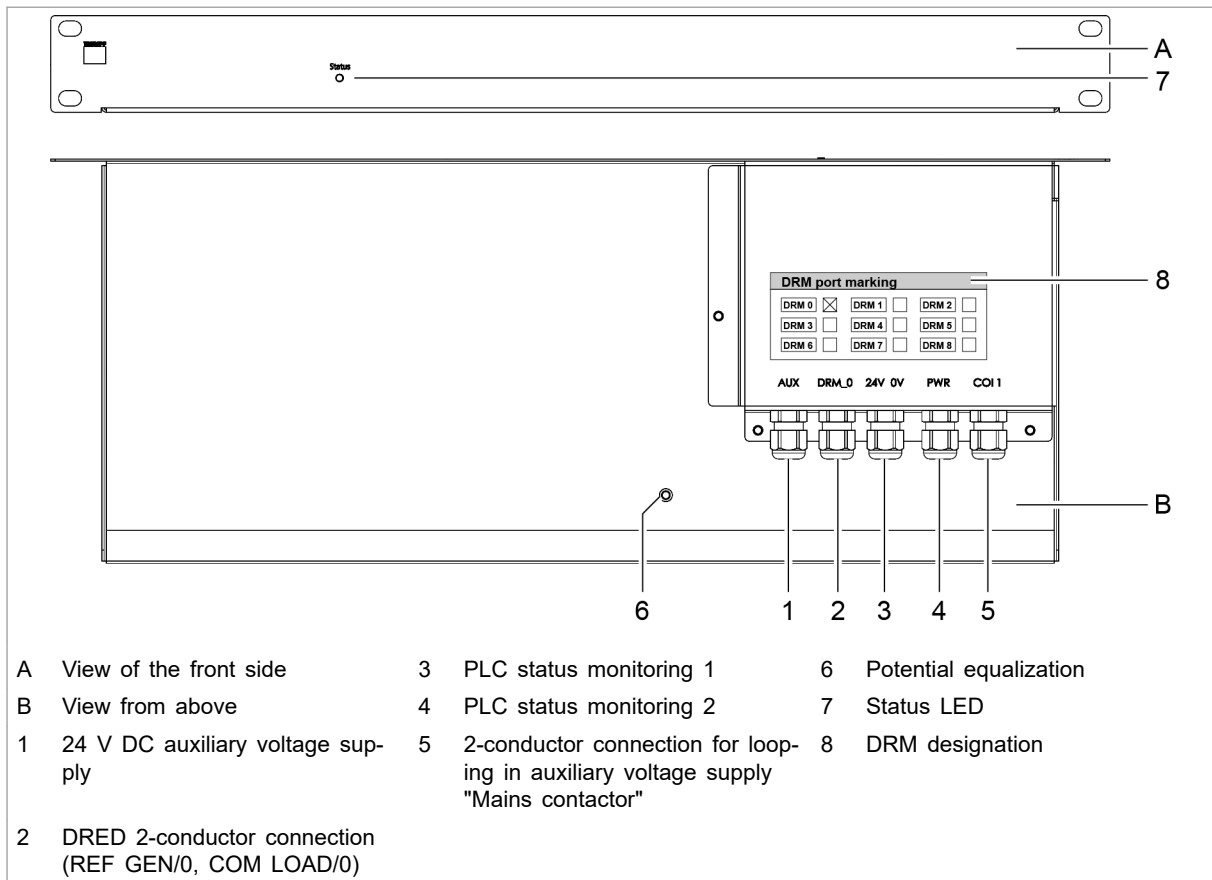
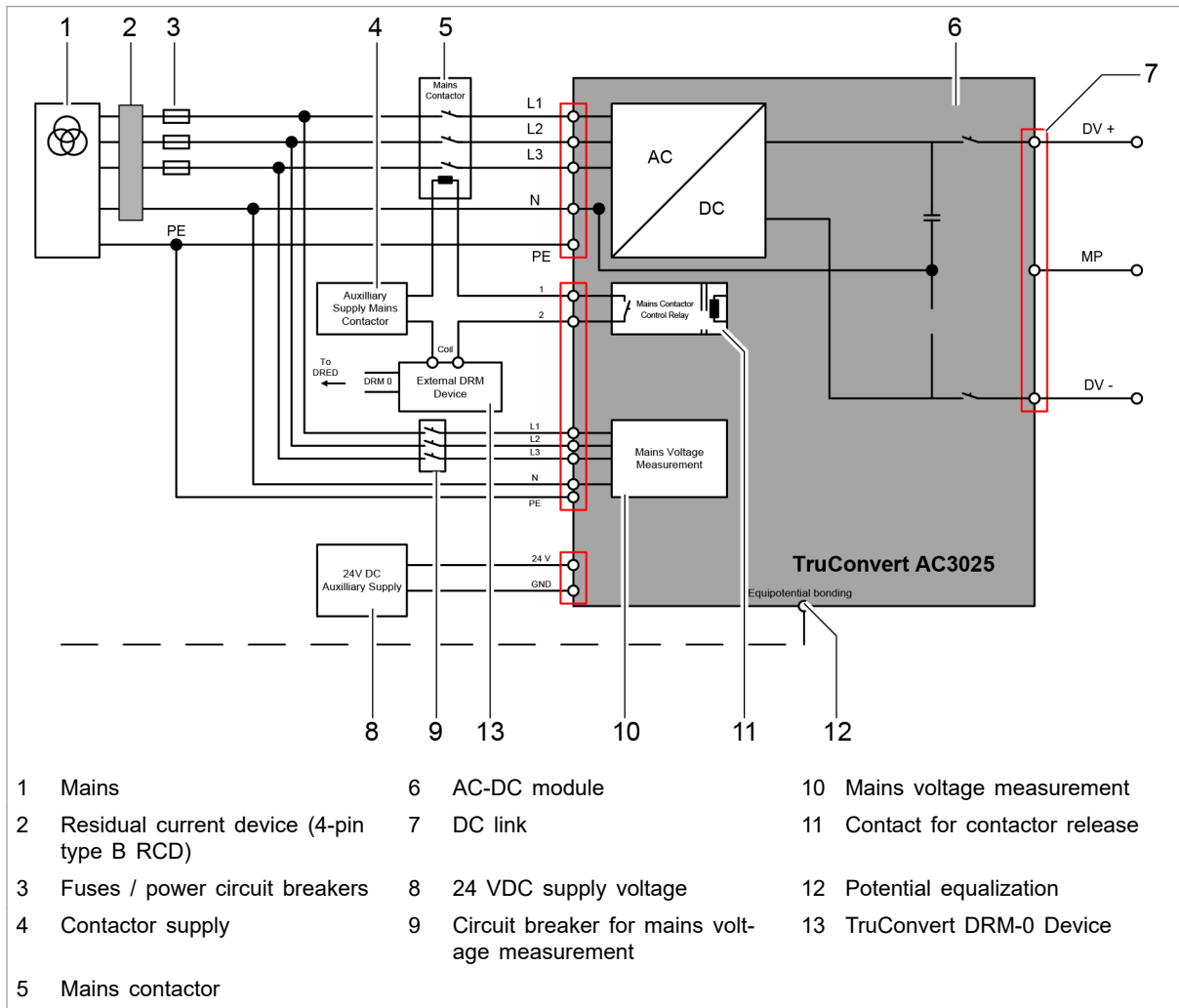

Fig. 33

Installing TruConvert DRM-0 Device

- Connect the TruConvert DRM-0 Device in series with the auxiliary voltage supply for the main switch (see "Fig. 34", pg. 56).
- Cable requirement: 10 × 1.5 mm² / 10 × AWG 16

Connection diagram for Australia and New Zealand and requirements regarding installation



Electrical connection (Australia–New Zealand)

Fig. 34

Customer area

The following components are not part of the AC-DC module, but must rather be provided by the customer:

- Residual current device (2)
 - Type B (RCD or similar)
 - Rated differential operating current $I_{\Delta n}$: 10 mA to 500 mA
 - Response delay t_{on} : 0 s to 10 s
 - Rated frequency: 0 Hz to 2000 Hz
 - Rated current: 40 A to 1000 A
- Fuses / power circuit breakers (3)

(see "Grid connection data", pg. 17)

- Mains contactor (5)
 - External load separation devices must meet the requirements of AS/NZS 4777.1.
 - It must be possible to disconnect all active conductors L1,L2, L3.
 - The neutral conductor may not be interrupted by separation devices.
 - AC separation devices checked according to AS/NZS 4777.2:2020 that together with TruConvert AC 3025 form the "Automatic Disconnection Device" required by the standard specified in section 4.2: ABB AF38-40-00-1 1 and EATON DIL MP125.
 - Dielectric strength corresponding to mains voltage: 400 / 480 V \pm 10%
 - Current-carrying capacity: 64 A
 - Operation mode: AC-3
- 24 VDC supply voltage (8)
(see "Entire device", pg. 17)
- Contactor supply (4)
 - Is switched via device-internal switching contact (11).
 - Permissible operational data for switching contact: 24 – 60 VDC, 5 A or 85 – 277 VAC, 5 A.
 - The 24 VDC supply voltage can be used to supply the mains contactor if necessary if voltage and power are sufficient.
- Circuit breaker for mains voltage measurement (9)
(see "Interfaces", pg. 22)
- Connection of energy sources to the DC link (7)
Observe the country-specific requirements regarding the installation of external DC separation devices.
 - The external DC separation device must satisfy the requirements of AS 60947.3.

Note

Observe regional requirements for the mains connection!

The regional requirements must be clarified at the customer's location with the mains operator before the device is connected and commissioned.

6.7 Requirements for grid-forming mode

TruConvert AC 3025 as voltage source in grid-forming mode

The device can be used as a grid-following inverter and as a grid-forming inverter. As a grid-forming inverter, it can be operated with up to 16 parallel units independently of the public grid. The device can form a stand-alone network on its own or together with other inverters (island operation).

Note

The function as "uninterruptible power supply" is not fulfilled and is not permissible.

Load cases in grid-forming mode

Permissible load cases:

- Resistive-symmetric three-phase alternating current load.
- Three-phase alternating current motors in star and/or delta configuration.
- 1-phase loads (resistive-inductive or capacitive-motoric).
- Unbalanced load with 1-phase loads:
 - A maximum unbalanced load of 4.6 kVA between the phases should not be exceeded.
The value is recommended based on normative requirements regarding connection to public low-voltage grids.
 - The device is designed for a maximum unbalanced load of 8.3 kVA between the phases.

NOTICE**Destruction of the device through excessive current on the neutral conductor!**

- Ensure that the nominal current on the neutral conductor is not exceeded in the case of asymmetries.

Impermissible load cases:

- Electrical loads that must ensure personal safety.
- Preservation of the electrical supply of medical devices of every type.
- Loads that could result in property and system damage if the stand-alone network is impaired.

In the event of questions regarding the general voltage supply in the stand-alone network through TruConvert AC 3025 or for the implementation of load cases that are not listed here, contact TRUMPF service.

Permissible system types in grid-forming mode

A system consisting of TruConvert AC 3025 may be operated in grid-forming mode in the following system configurations:

- TN-C system.
- TN-C-S system.

The corresponding system images are shown in VDE-AR-E-2510-2:2015-09 Appendix B.

Observe the following points:

- N conductor and PE conductor are not connected in the TruConvert AC 3025.
- N conductor and PE conductor must be connected outside of the TruConvert AC 3025.
- In TN-C systems and in the TN-C part of a TN-C-S system, the PEN conductor must not be separated.

Central earthing point in stand-alone network

If the TruConvert AC 3025 is alternately operated parallel to the public grid and within a stand-alone network, a central earthing point (CEP) must be provided within the stand-alone network. The current-carrying capacity up to the CEP must also be ensured.

In order to provide a CEP as soon as the connection to the public grid is disconnected and switches to island operation, it may be necessary to install an earthing switch.

Example:

If the inverter is disconnected at all poles (L1, L2, L3, N) from a grid in the TNC-S system, operation as a stand-alone network is only possible if the N-PE connection is restored using an earth selector switch (see "Fig. 35", pg. 59).

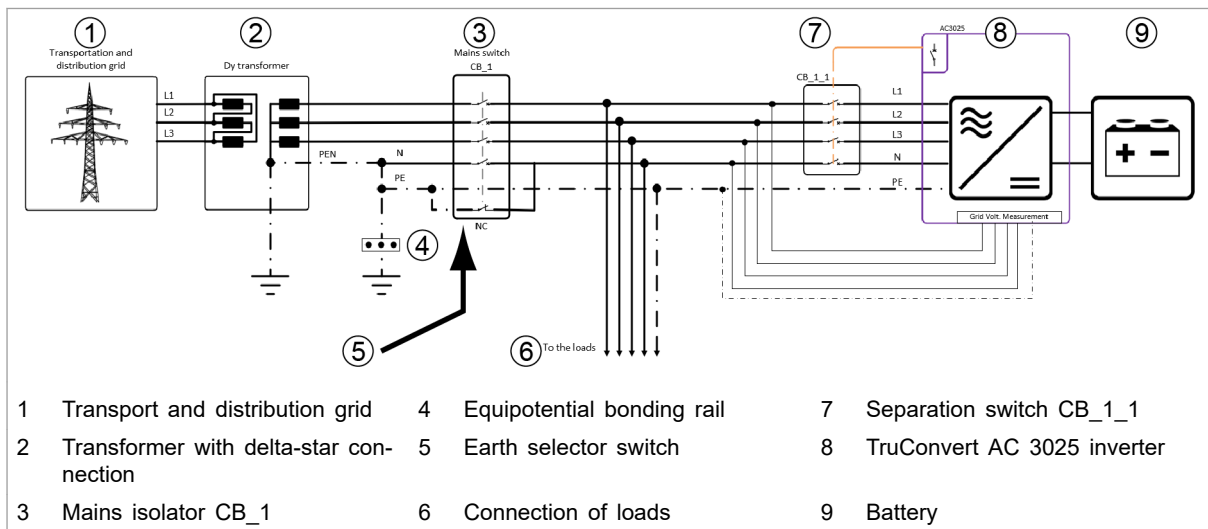

Earth selector switch for all-pole mains separation in TNC-S system

Fig. 35

Electrical protection devices in grid-forming mode

- The setup of low-voltage systems with an isolated supply must satisfy the requirements of DIN VDE 0100-100 or the corresponding country-specific regulations.

Making settings for grid-forming mode

Other information, (see "Operation with voltage regulation (grid-forming or grid-following mode)", pg. 106).

6.8 Series-connected batteries on DC link

2 batteries can be connected in series to the DC link: battery 1 to the positive DC link half and battery 2 to the negative DC link half. In this arrangement, the power flow in the two batteries can be set independently of each other.

Other information, (see "Function description "Operation with series-connected batteries"", pg. 117).

Connecting 2 batteries in series

⚠ WARNING

Risk of electric shock!

The neutral point (MP) of the DC link ("MP") is connected to the neutral conductor inside the device.

An incorrectly connected "MP" can cause circulating currents. There is then a risk of touch contact with a live conductor.

- Connect the "MP" only to the potential-free batteries.
- Do not make any further connections to grid-tied or earth-tied potentials.

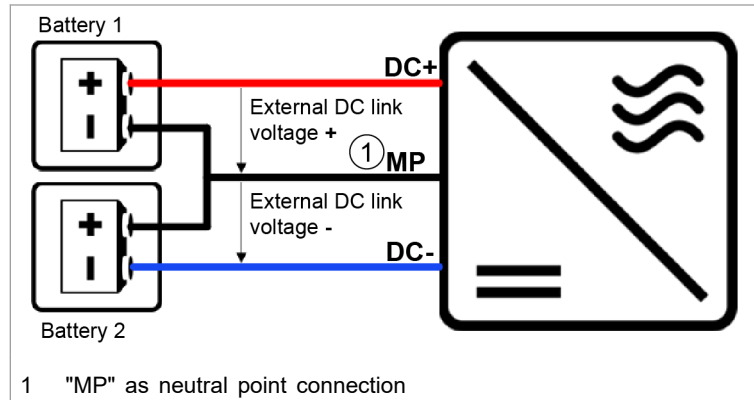

Connection principle for operation with series-connected batteries Fig. 36

1. At the "DC Link" connector, connect battery 1: Between "DC +" and "MP".
(Positive DC link half)
2. Connect battery 2: Between "MP" and "DC-".
(Negative DC link half)
3. Make the settings for series-connected batteries: (see "Function description "Operation with series-connected batteries"", pg. 117).

6.9 Dismantling

WARNING

Connection cables carry life threatening voltage!

- Open the external mains separation device between mains and the power connection of the device.
- De-energize the cable between mains and the mains synchronization connection.
- De-energize the connection cables to the DC link voltage.
- Maintain discharging time: at least 5 min.

Removing residual voltages

1. Open external mains separation device.
2. De-energize the connection cables to the DC link voltage.
3. De-energize the connection cables to the 24 V supply voltage.

WARNING

Dangerous residual voltage

- Maintain discharging time: at least 5 min.

Unscrew or unplug cables

4. Check mains cable and DC link-voltage cable to ensure that they are not electrically live.
5. At power connection "Mains":
 - Undo the 2 screws on the flange.
 - Disconnect mains cable.
6. At DC link connection:
 - Undo the 2 screws on the flange.
 - Disconnect the DC link cable.
7. At connection for contactor release contact and mains voltage measurement "Contactor / Mains Measurement":
 - Release the automatic locking mechanism.
 - Disconnect the cable for mains voltage measurement / release contact.
8. 24 V supply voltage:
 - Release the automatic locking mechanism.
 - Disconnect the 24 V supply cable.
9. Disconnect data cable.
10. Unscrew and remove the equipotential bonding conductor if necessary.

6.10 Shipping the module

- Use packaging material which can withstand transport stresses to ship the module.

If the original packaging is no longer available:
Suitable packaging material can be purchased from
TRUMPF.

6.11 Disposing of the module

- Observe the local regulations when disposing of the module.

7. Operation

7.1 Commissioning

Performing initial commissioning

Conditions

- PC on which one of the following browsers is installed:
 - Microsoft Internet Explorer from version 11.
 - Microsoft Edge.
 - Google Chrome from version 46.
 - Firefox from version 40.
- Ethernet cable for connecting PC and TruConvert System Control.

The initial commissioning of the device is **only** possible via the web GUI.

Establishing and testing the connection

1. Set the same IP Subnet Mask on the PC as on the TruConvert System Control.
IP Subnet Mask of the TruConvert System Control on delivery: 255.255.255.0
2. Set the same address range on the PC as on the TruConvert System Control:
192.168.1.-
3. On the PC, set the last block of the IP address.
Do not set the same address as on the TruConvert System Control!
IP address of the TruConvert System Control on delivery: 192.168.1.2
Do not set 0!
4. Connect PC and TruConvert System Control with Ethernet cable.
5. To switch on the system control and the AC-DC module: switch on the 24 V supply voltage.
All 3 status LEDs blink to display the "Initialization" state.
6. Open the web browser on the PC.
7. Enter IP address of the TruConvert System Control in the address line.
IP address of the TruConvert System Control on delivery: 192.168.1.2

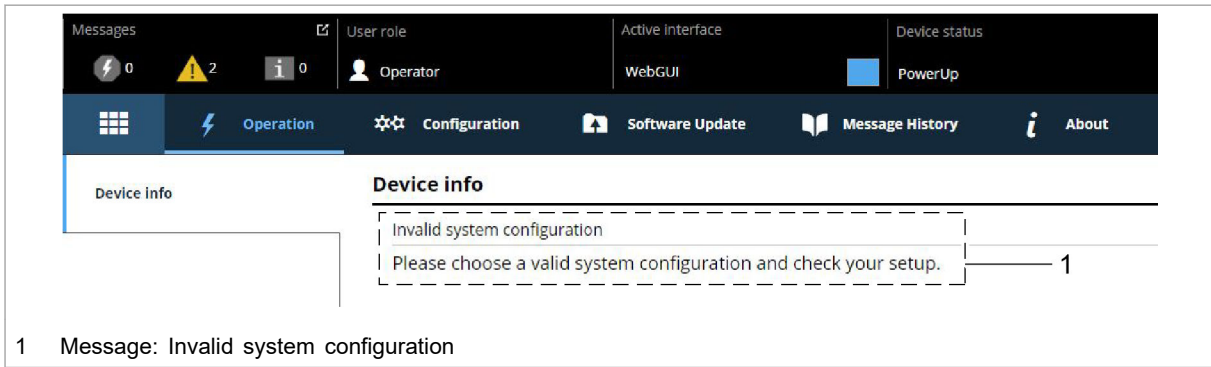

Initial commissioning display

Fig. 37

The browser displays the web GUI.

Several system controls are used in one system?

- Connect one system control after another to the PC and change the default IP address to a unique IP address.

Setting the system configuration

8. Select >Configuration >System configuration.

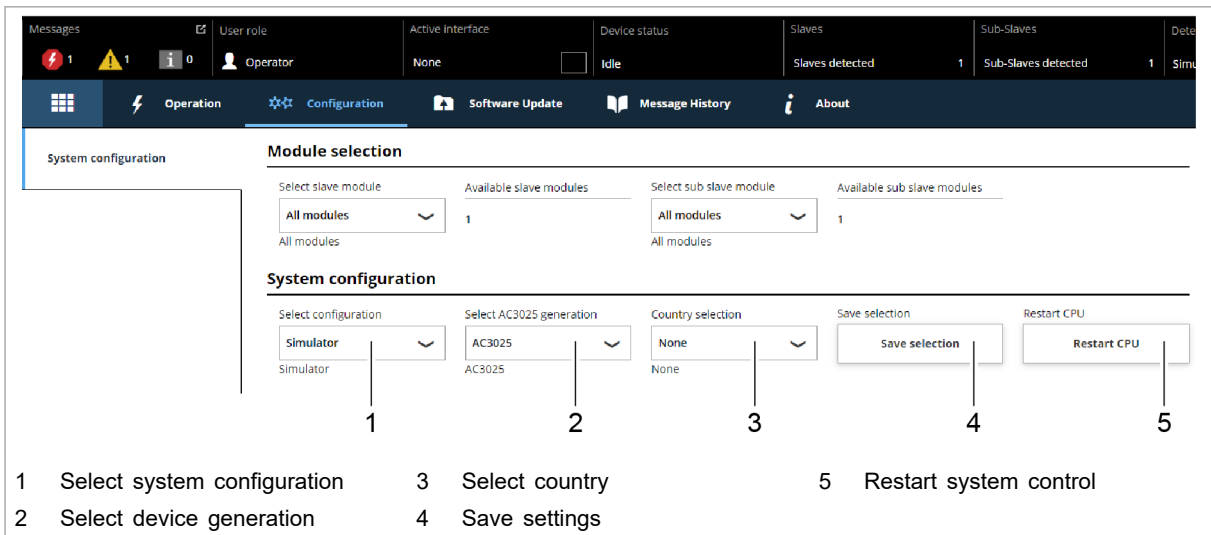

Screen: Set system configuration

Fig. 38

- In the "Module selection" section under "Select slave module", select: "All modules".
- In the "System configuration" section under "Select configuration", select the existing system configuration:
 - No configuration
This configuration only occurs in the event of an error, e.g., if there is no connection to the modules (check cables) or if an incorrect module type was detected (check alarm messages).
 - Simulator
The system control alone is used and connected modules are simulated.

- DC-DC configuration
Only DC-DC modules are connected to the system control.
 - $n \cdot (\text{AC-DC} + m \cdot \text{DC-DC})$
AC/DC and DC/DC modules are connected to the system control.
11. Under "Select AC3025 generation", select the device generation: "AC3025".
 12. Under "Country selection", select the location of the device.
If the factory setting "None" is retained, it will not be possible to switch on the device later.
 13. To save the selection: press "Save selection".
 14. To restart the TruConvert System Control: press "Restart CPU".

The system control balances the set system configuration with the actually connected modules. If both values match, the set system configuration is displayed in the status bar under "Detected Configuration".

If the set system configuration differs from the automatically detected system configuration, "None" is displayed in the status bar under "Detected Configuration". In addition, a message is output. Press  in the sidebar to display the messages.

Set process set values ("AC-DC module settings")

15. Select *>Operation >AC-DC module settings*.
16. Every input in the following steps must be confirmed with the enter key ↵.

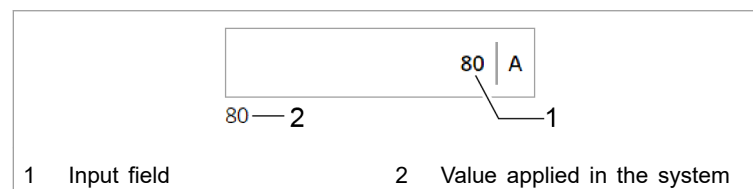

Confirm input Fig. 39

The value applied in the system is then displayed below the input field.

17. To ensure that the settings apply to all AC-DC modules:
 - User interface:
In the "Module selection" section, under "Select slave module", enter "All modules".
 - Modbus: (see "Tab. 28", pg. 91)
Enter the number of the slave to be addressed = "0".
18. In the "General AC settings" section under "Controler and grid type selection", select the regulator type as well as the grid voltage and grid frequency:

- Mains current regulation + voltage/frequency of AC grid.
E.g. "Current control 400 V / 50 Hz (grid-tied only)"
 - voltage regulation + voltage/frequency of AC grid.
Additionally under "Voltage source mode", select the regulation mode (see "Operation with voltage regulation (grid-forming or grid-following mode)", pg. 106).
E.g. "Voltage control 480 V / 60 Hz" and "grid-forming".
19. In the "Power factor convention", select operation mode:
- "Producer": producer reference arrow system.
Positive sign for $\cos\phi$ means: energy flows from DC link towards mains.
Negative sign for $\cos\phi$ means: energy flows from mains towards DC link.
(see "Fig. 40", pg. 66)
 - "Consumer": consumer reference arrow system.
Positive sign for $\cos\phi$ means: energy flows from mains towards DC link.
Negative sign for $\cos\phi$ means: energy flows from DC link towards mains.
(see "Fig. 41", pg. 67)

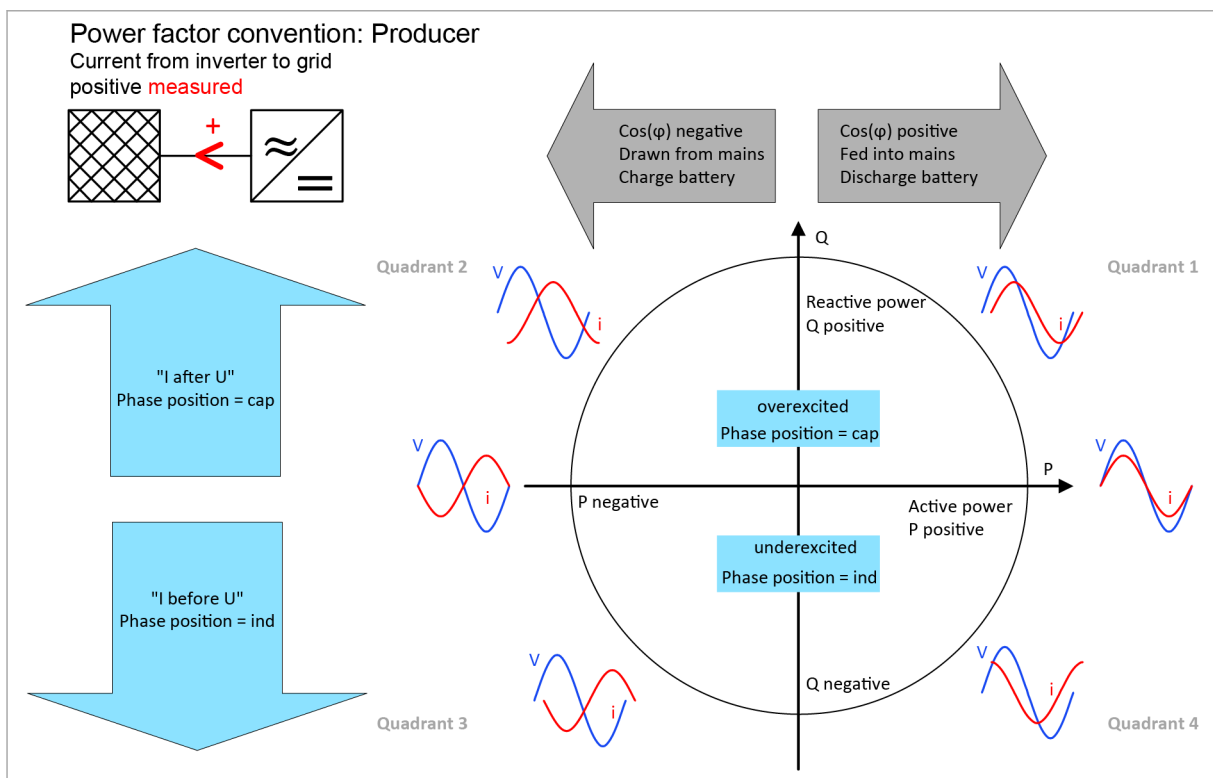

Producer reference arrow system

Fig. 40

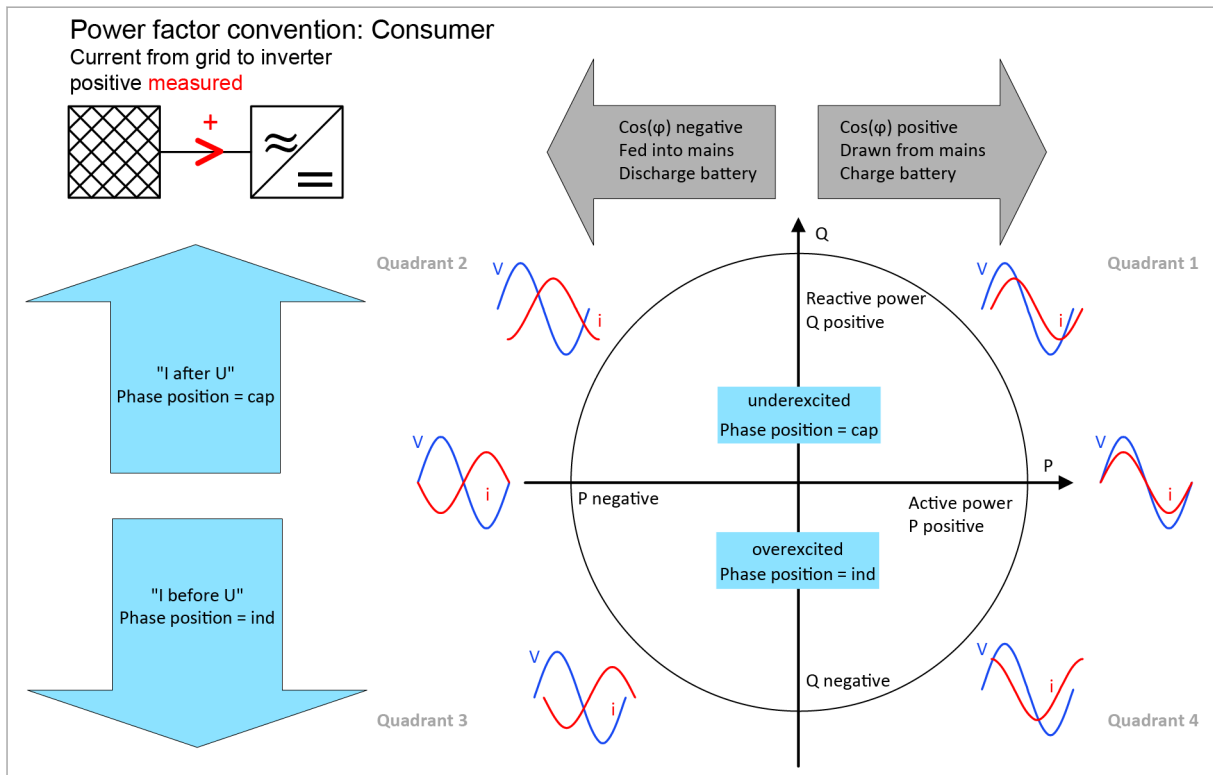

Consumer reference arrow system

Fig. 41

20. Under "Grid contactor delay", enter the maximum delay time in ms that may elapse between the "Close contactor" command and the actual closing of the contactor.
- If there is no feedback within the delay time, an alarm is output.

Setting the DC link ("DC link settings")

21. Change preset values:
- No: The DC link settings made at the factory are appropriate for most applications.
 - Yes: This can be useful with energy storage systems that are directly connected to the DC link (see "Setting DC link with "voltage regulation" regulator type", pg. 101).

Setting the "AC voltage control settings"

22. If the "voltage regulation" regulator type is used ("Controller and grid type selection" = "Voltage control ..."): Under "AC voltage control settings", enter the corresponding parameters (see "Operation with voltage regulation (grid-forming or grid-following mode)", pg. 106).

Setting operation with series-connected batteries ("Stacked HV battery settings")

23. If 2 series-connected batteries are used: Under "Stacked HV battery settings", enter the corresponding parameters (see "Operation with series-connected batteries", pg. 117).

Setting grid codes ("Grid code control settings")

24. Under "Grid code control settings", enter the corresponding parameters (see "Setting grid codes", pg. 123).

Start transmission of power

25. Check the device status in the status bar at the top of the user interface:
 - "Device status: Idle": Idle: The device is ready for use.
 - "Device status: Error, Power Up": Error: The device is not ready for use. An alarm message is pending (see "Displaying and resetting messages", pg. 94).

or

 - Check status LED 1 on the AC-DC module and system control:
 - LED flashes green: The device is ready for use.
 - LED flashes red: The device is not ready for use. An alarm message is pending (see "Displaying and resetting messages", pg. 94).
26. Select *>Operation >Device control AC-DC mode*.
27. In the "Device control AC-DC" section, enter in "Power factor cos(φ)":
 - Value between: -1 to +1 (in increments of 0.01)
 - Note the selected reference arrow system and set the sign accordingly.
28. In the "Device control settings AC-DC" area under "DC link precharge config", set from which side the DC link voltage is to be precharged:

Web GUI	Mod-bus register 4005	Description
	Bit	
external	0	Device is waiting for external precharging of the DC link.
internal	1	Device is charging the DC link to the required voltage.
internal with DC module	2	Setting similar to "internal" with support of the DC-DC modules (required in isolated mode).
internal & wait	3	Device is charging the DC link to the required voltage and is waiting until "DC link precharge config" is set back to "internal" or "internal with DC module" in order to connect to the AC grid.

Tab. 21

29. Under "Activate power stage": click on the slide control.

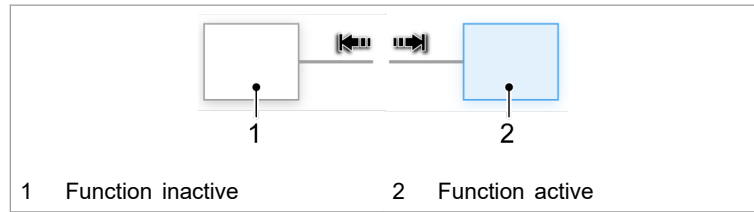

Slide control

Fig. 42

The slide control changes position and is displayed in blue: The function is active.

In the status bar, the operating state changes from "Idle" to "Operation".

The status LEDs on the AC-DC module and system control light up orange. The contactor connects the mains.

Stop transmission of power

30. To stop the transmission of power: press "Activate power stage" again.

The slide control changes position and is displayed in white: The function is disabled.

In the status bar, the operating state changes from "Operation" to "Idle".

The status LEDs on the AC-DC module and system control light up green. The contactor disconnects the mains.

The initial commissioning is completed.

The device can now continue to be operated via the web GUI or via Modbus.

Tip

The Modbus register provides an overview of the set default values (see "Modbus Register Map", pg. 77).

7.2 Active interface

The device can be **simultaneously** controlled via the web GUI and Modbus.

Enabling/disabling interface

- Web GUI: In the "Interface control" area of the  expandable menu, click on the slide control.
- Other interfaces: get/release control via interface command, (see "Modbus Register Map", pg. 77).

Communication timeout

During power operation ("Device status" = "operation"), communication between the active interface and the device is monitored. As soon as no communication occurs for a period exceeding the time-out time, the device switches off with an alarm message.

Setting the time-out time:

- Select *>Configuration >System configuration*.
- In the "General system settings" area, enter the desired time under "Active interface communication timeout".
- To switch off the time-out mechanism: enter 65535.

7.3 Operation via web-based user interface

Calling up the web GUI

Condition

- Initial commissioning was performed (see "[Commissioning](#)", pg. 63).
1. To switch on the TruConvert System Control and the connected modules: switch on the 24 V supply voltage.
 2. Open the web browser on the PC.
 3. Enter IP address of the TruConvert System Control in the address line.

IP address of the TruConvert System Control on delivery:
192.168.1.2

The browser displays the user interface of the TruConvert System Control and the connected modules.

Orientation of the user interface

After entering the IP address in a web browser, the web GUI opens.

Start screen

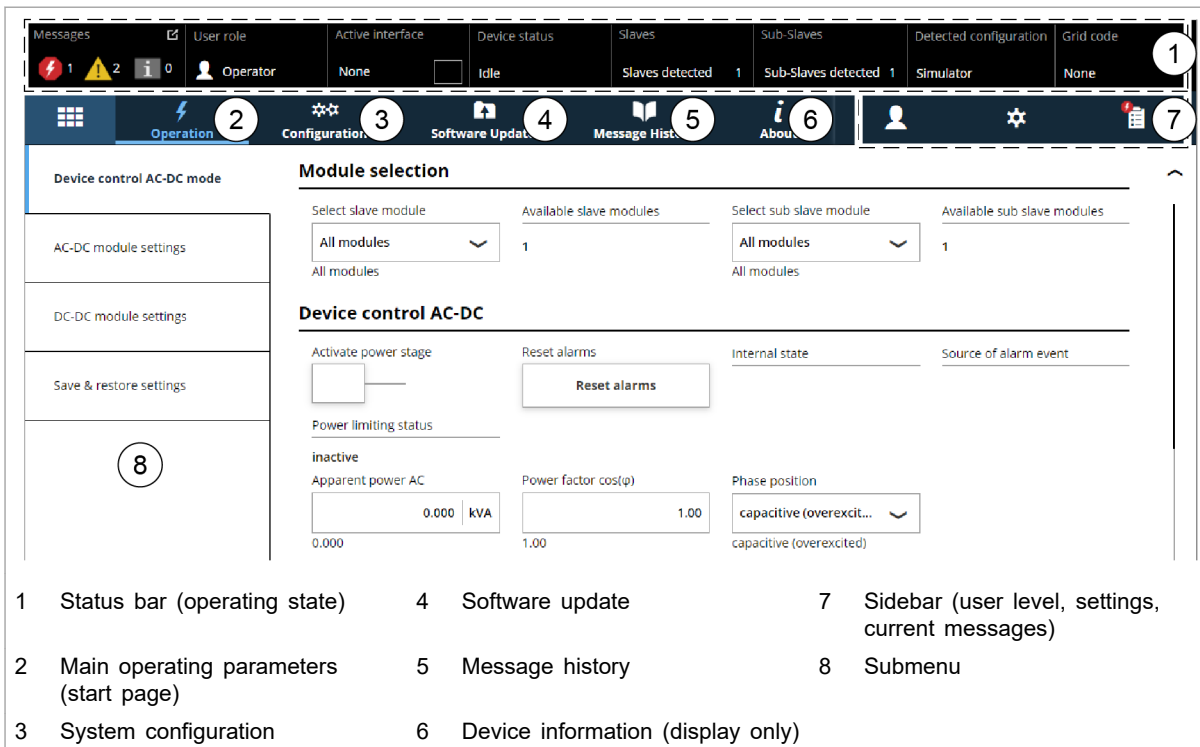

Start screen

Fig. 43

User interface

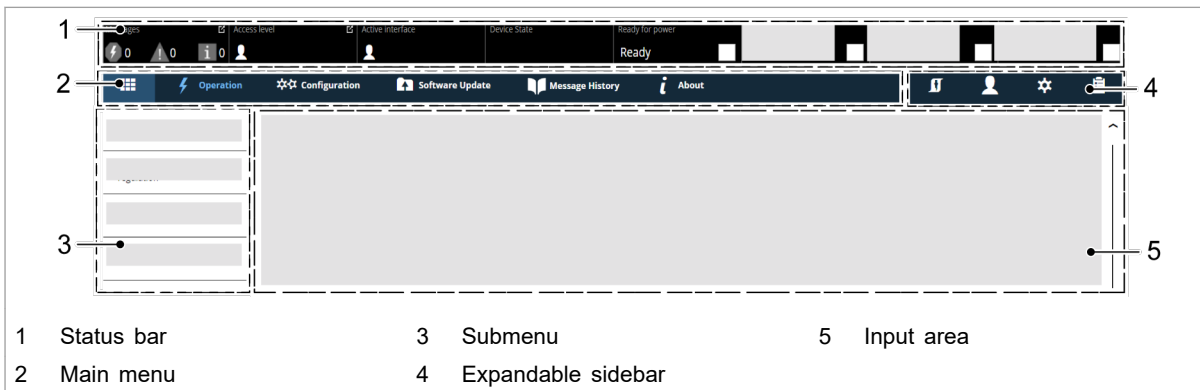

Arrangement of the user interface

Fig. 44

Status bar signaling

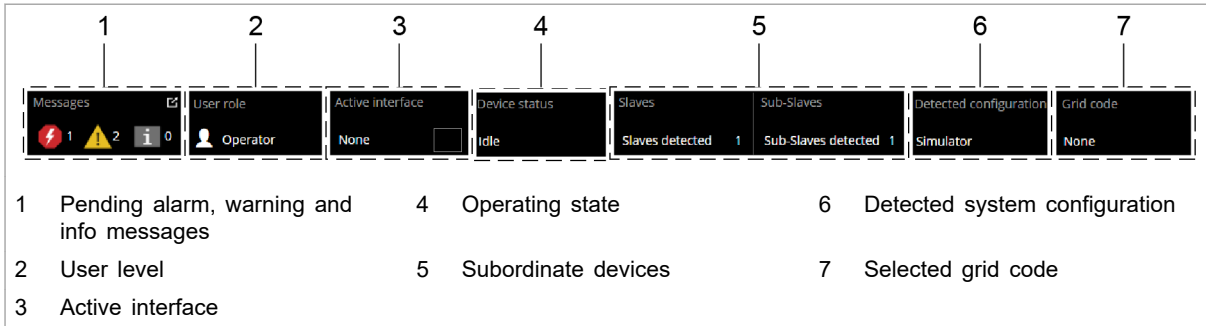

Status bar: information

Fig. 45

Expandable sidebar The sidebar is divided into three menu items that are labeled with an icon.

- User settings
- Network settings
- Pending messages

Simply click on the icon to open / close the submenu.

"Change user role" <ul style="list-style-type: none"> ▪ Display active user role. ▪ Change user role. 	Set system clock and date.	"Pending messages" <ul style="list-style-type: none"> ▪ "Alarm" ▪ "Warning" ▪ "Info" <p>Note</p> The display can be activated / deactivated for each message type.
"Interface control" <ul style="list-style-type: none"> ▪ Activate the web GUI. ▪ Deactivate the web GUI. 	Network settings <ul style="list-style-type: none"> ▪ enter ▪ edit 	"Reset" <p>Pending messages in the generator are deleted.</p> <p>More information, (see "Displaying and resetting messages", pg. 94).</p>

Overview of expandable sidebar

Tab. 22

Main menu

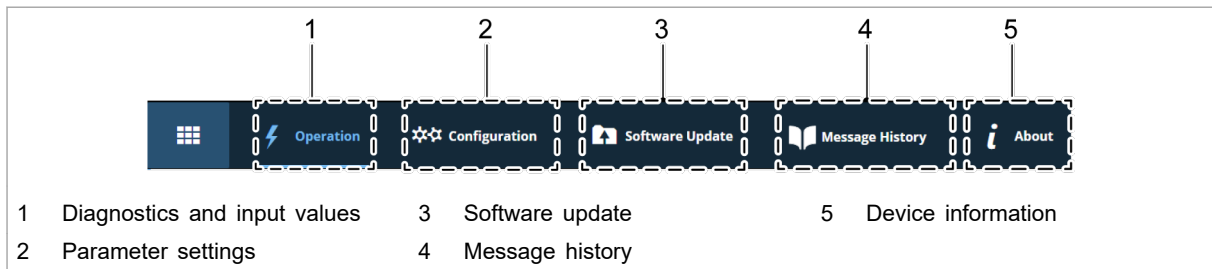

Main menu

Fig. 46

Input area Clicking on the submenu items opens the input area. Displayed here are the areas of the submenu items for reading or editing. Operation is explained in the individual chapters of the function descriptions.

Input functions:

- Selection fields
- Input fields
- Slide control

Input fields

A new entry is activated by pressing the Enter key.

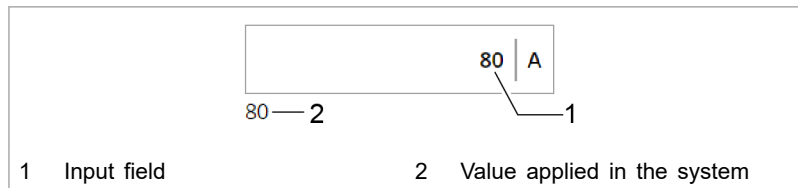

Confirm input

Fig. 47

Slide control

The slide control is moved with a simple click.

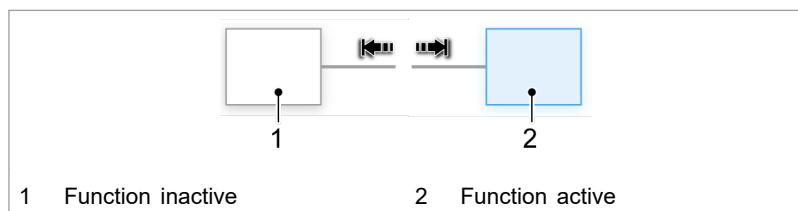



Slide control

Fig. 48

Menu structure

Global menu structure (expandable sidebar)

Main menu	Area	Description
Operation Settings 	<ul style="list-style-type: none"> ▪ >Change User Role. ▪ >Interface Control. 	<ul style="list-style-type: none"> ▪ Setting the user roles (For service only) ▪ Enabling interface, (see "Active interface", pg. 69).
System settings 	<ul style="list-style-type: none"> ▪ System clock and time setting ▪ Network settings 	<ul style="list-style-type: none"> ▪ (see "Setting the system time", pg. 125). ▪ (see "Changing network settings", pg. 126).
Messages 	>Pending messages	(see "Displaying messages of the web GUI", pg. 94).

Menu structure of the sidebar

Tab. 23

Menu structure of the main menu

Main menu	Submenu	Description
>Home	—	Start screen (see "Calling up the web GUI", pg. 70)
>Operation	>Device control AC-DC mode	(see "Transmission of power", pg. 91) (see "Actual values", pg. 100)
	>AC-DC module settings	"General AC settings" (see "Set process set values (AC-DC module settings)", pg. 65) "DC link settings" (see "Setting DC link with "voltage regulation" regulator type", pg. 101) "AC voltage control settings" (see "Operation with voltage regulation (grid-forming or grid-following mode)", pg. 106) "Stacked HV battery settings" (see "Operation with series-connected batteries", pg. 117) "Grid code control settings" (see "Setting grid codes", pg. 123)
	>DC-DC module settings	Menu item only present if the DC-DC modules are also connected to the AC-DC module. See the "TruConvert DC 1008-1010" or "TruConvert DC 1030" operator's manual.
	>Save & restore settings	(see "Saving parameters and resetting to factory settings", pg. 120)
>Configuration	>System configuration	(see "Setting the system configuration", pg. 121) (see "Communication timeout", pg. 69) (see "Setting grid codes", pg. 123)
>Software Update	—	(see "Perform software update", pg. 127)
>About	—	(see "Displaying device information", pg. 128)

Menu structure of the web GUI

Tab. 24

7.4 Operation via Modbus

Protocol: TCP/UDP.

Differences for Modbus – user interface

Note

Operation via Modbus is the standard method of operation for regular operation.

Configuration, initial commissioning and software update of the TruConvert System Control and the connected modules can be performed via the user interface.

Function	User interface	Modbus
Operation	x	x
System configuration	x	x
Software update	x	—
Changing the IP address	x	—
Data backup	x	—

Differences in operation

Tab. 25

Instructions for using Modbus

Instructions and information for using Modbus are given mainly in this sub-chapter "Operation via Modbus". The individual Modbus registers and their description can be found in the Modbus Register Map (see "Modbus Register Map", pg. 77).

In cases where a more detailed explanation of the procedure via Modbus is required, an additional description for using Modbus is given in the chapter "Operation" of the general description (web GUI).

Establishing a connection

Condition

- Initial commissioning was performed (see "Commissioning", pg. 63).
1. Connect the TruConvert System Control to the Modbus master with an Ethernet cable.
 2. To switch on the system control and the modules: switch on the 24 V supply voltage.

The PCS (Power Conversion System) is ready for communication via Modbus.

Addressing modules via Modbus

Within a configuration consisting of the system control, multiple AC-DC modules and multiple DC-DC modules, it is possible to address a specific module directly via the Modbus.

There are two ways to address a module:

- Addressing with registers 4007 and 4010 (default setting)
- Addressing via slave ID/unit ID (alternative)

Only one of the two options can be selected. It is not possible to use both simultaneously.

Addressing modules via Modbus registers 4007 and 4010

1. To address an AC-DC module (slave modules), enter the following in register 4007:
 - 0 = Address all slave modules.
 - 1 – n = Address selected slave module.
2. To address a DC-DC module (subslave modules), enter the following in register 4010:
 - 0 = Address all subs slave modules.
 - 1 – m = Address selected subs slave module.

Address modules via slave ID (unit ID)

1. Set Modbus register 4011 to 1.
2. To address a module directly in the Modbus register:
 - Specify the address of the desired module in field "Slave-ID".
 - Observe the structure of the module address.

Structure of the module address	Description
AC-DC module ("Slave-ID")	<ul style="list-style-type: none"> ▪ The slave ID has max. 3 digits (0 to 169). ▪ Slave ID = 1 to 16: The command is transmitted to the explicitly named slave (AC-DC module). ▪ Slave ID = 0: The command is transmitted to all connected slaves. ▪ Accesses to a slave register with slave IDs > 16 are ignored.
DC-DC module (combination of "Slave-ID" and "Sub slave module")	<ul style="list-style-type: none"> ▪ Slave ID = (slave number x 10) + subs slave number: The command is transmitted to the explicitly named "Sub slave module". ▪ Slave ID = 0: The command is transmitted to all connected subs slaves. ▪ Accesses to a subs slave register with slave IDs < 10 or > 169 are ignored.

Definition: structure of the module address

Tab. 26

Register for	Slave no.	Sub slave no.	"Slave-ID"	Description
Slave	3	–	3	To slave 3.
Slave	0	–	0	To all slaves.
Subslave	1	4	14	To subs slave 4 from slave 1.
Subslave	16	4	164	To subs slave 4 from slave 16.
Subslave	1	0	10	To all subs slaves from slave 1
Subslave	16	0	160	To all subs slaves from slave 16
Subslave	0	0	0	To all subs slaves.

Examples: structure of the module address

Tab. 27

Modbus Register Map

- Base settings: address range 1000 to 1999
- Info system: address range 2000 to 2399
- Alarm and warning messages: address range 2400 to 3999
- Process set values: address range 4000 to 4999
- Process actual values: address range 5000 to 5999

Addr	Description	Unit	Resolution	Default	Min	Max	Data type	Type	Length	FCr	FCw
1000	Date	dd. mm. YYYY					UINT32	Register	2	03	16
1002	Time	hh: mm: ss					UINT32	Register	2	03	16
1004	IP address	xxx. xxx. xxx. xxx		0xC0A80102	1	0xFFFFFFF	UINT32	Register	2	04	
1006	Subnet	xxx. xxx. xxx. xxx		0xFFFFFFFF0	1	0xFFFFFFF	UINT32	Register	2	04	
1008	Gateway	xxx. xxx. xxx. xxx		0xC0A80101	1	0xFFFFFFF	UINT32	Register	2	04	
1010	Reset parameters to factory settings	-	1.0	0	0	1	UINT16	Coil	1	01	05

Addr	Description	Unit	Resolution	Default	Min	Max	Data type	Type	Length	FCr	FCw
1016	Master communication timeout (65535 disables mechanism)	s	1.0	10	1		UINT16	Register	1	03	06
1017	Setting this flag will restart the CPU (only in idle or error state)	-	1.0	0	0	1	UINT16	Coil	1	01	05
1018	Setting for connected system configuration: No config = 0, Simulator config = 1, DC-DC only config = 2, n*AC-DC m*DC-DC config = 3	-	1.0	0	0	6	UINT16	Register	1	03	06
1026	1: triggerst automatic system software update (if necessary)			0	0	1	UINT16	Register	1	03	06
1027	1: automatic system software update required			0	0	1	UINT16	Register	1	04	
1028	Variable to save or reset customer values: 1: save parameter -1: restore default settings	-	1.0	0	-1	1	INT16	Register	1	03	06
2000	Serial number system control	String					UINT32	Register	2	04	16
2008	Serial number AC-DC module	-	1.0		0		UINT32	Register	2	03	16
2050	Integration level (device software)			0			UINT16	Register	1	03	
2051	Buildnumber of integration level			0			UINT16	Register	1	03	
6493	Material number AC-DC module	-	1.0		0		UINT32	Register	2	03	16
4000	Power stage configuration: 1 = power stage on; 0 = power stage off;	-	1.0	0	0	1	UINT16	Coil	1	01	05
4001	Configuration AC set values for phases L1 - L3: 1 = symmetric; 0 = asymmetric (individual configuration possible);	-	1.0	1	0	1	UINT16	Coil	1	01	05
4002	Resets current alarm and warning messages	-	1.0	0	0	1	UINT16	Coil	1	01	05

Addr	Description	Unit	Resolution	Default	Min	Max	Data type	Type	Length	FCr	FCw
4005	Precharge DC link configuration: 0 = device waits for external precharge of DC link 1 = device precharges external DC link to necessary start-up voltage 2 = behaviour similar to 1 with additional support of DC submodules (necessary for island operation) 3 = device precharges external DC link to necessary start-up voltage and waits until PrechargeDcLinkConfig gets set back to 1 or 2	-	1.0	1	0	3	UINT16	Register	1	03	06
4006	Sets reference frame convention (0 = producer reference frame; 1 = consumer reference frame)	-	1.0	0	0	1	UINT16	Register	1	03	06
4007	Specifies the slave that will be addressed (0 = broadcast / same values for all slaves)	-	1.0	0	0	16	UINT16	Register	1	03	06
4008	Alarm policy for modules: 0 = strict (system switches to alarm state if at least one module is in alarm state) 1 = relaxed (system switches to alarm state if all modules are in alarm state)	-	1.0	0			UINT16	Register	1	03	06
4009	Grid type: 0 = grid-tied, 400V, 50Hz 1 = grid-tied, 480V, 60Hz 2 = island mode, 400V, 50Hz 3 = island mode, 480V, 60Hz 4 = grid-tied, 380V, 60Hz	-	1.0	0	0	4	UINT16	Register	1	03	06
4010	Specifies the sub slave that will be addressed (0 = broadcast / same values for all sub slaves)	-	1.0	0	0	16	UINT16	Register	1	03	06
4011	Use the modbus slave ID for addressing	-	1.0	0	0	1	UINT16	Coil	1	01	05

Addr	Description	Unit	Resolution	Default	Min	Max	Data type	Type	Length	FCr	FCw
4012	Alarm policy for sub-modules: 0 = strict (AC-DC module switches to alarm state if at least one sub-module is in alarm state) 1 = relaxed (AC-DC module switches to alarm state if all sub-modules are in alarm state) 2 = off (If possible AC-DC module continues operation even if all sub-modules are in alarm state)	-	1.0	0	0	2	UINT16	Register	1	03	05
4182	0 = Power setpoints become active immediately 1 = Power setpoints become active after trigger is set (register 4183)	-	1.0	0	0	1	UINT16	Register	1	03	06
4183	0 = Idle 1 = Send power setpoints	-	1.0	0	0	1	UINT16	Register	1	03	06
4184	Switch to change inputs from S, cosphi, Phase-Cap to P, Q	-	1.0	0	0	1	UINT16	Register	1	03	06
4185	Active Power set value AC (Only available with ARN4110 or AS/NZS 4777.2)	kW	0.001	0	-37500	37500	INT32	Register	2	03	16
4187	Reactive Power set value AC (Only available with ARN4110 or AS/NZS 4777.2)	kVAr	0.001	0	-37500	37500	INT32	Register	2	03	16
4189	Active Power set value AC L1 (Only available with ARN4110 or AS/NZS 4777.2)	kW	0.001	0	-12500	12500	INT16	Register	1	03	06
4190	Active Power set value AC L2 (Only available with ARN4110 or AS/NZS 4777.2)	kW	0.001	0	-12500	12500	INT16	Register	1	03	06
4191	Active Power set value AC L3 (Only available with ARN4110 or AS/NZS 4777.2)	kW	0.001	0	-12500	12500	INT16	Register	1	03	06
4192	Reactive Power set value AC L1 (Only available with ARN4110 or AS/NZS 4777.2)	kVAr	0.001	0	-12500	12500	INT16	Register	1	03	06
4193	Reactive Power set value AC L2 (Only available with ARN4110 or AS/NZS 4777.2)	kVAr	0.001	0	-12500	12500	INT16	Register	1	03	06

Addr	Description	Unit	Resolution	Default	Min	Max	Datatype	Type	Length	FCr	FCw
4194	Reactive Power set value AC L3 (Only available with ARN4110 or AS/NZS 4777.2)	kVAr	0.001	0	-12500	12500	INT16	Register	1	03	06
4195	Signed power set value AC (sign influences cos phi)	kVA	0.001	0	-32000	32000	INT16	Register	1	03	06
4196	Signed power set value AC L1 (sign influences cos phi)	kVA	0.001	0	-12500	12500	INT16	Register	1	03	06
4197	Signed power set value AC L2 (sign influences cos phi)	kVA	0.001	0	-12500	12500	INT16	Register	1	03	06
4198	Signed power set value AC L3 (sign influences cos phi)	kVA	0.001	0	-12500	12500	INT16	Register	1	03	06
4199	Power set value AC	kVA	0.001	0	0	37500	UINT16	Register	1	03	06
4200	Power set value AC L1	kVA	0.001	0	0	12500	UINT16	Register	1	03	06
4201	Power set value AC L2	kVA	0.001	0	0	12500	UINT16	Register	1	03	06
4202	Power set value AC L3	kVA	0.001	0	0	12500	UINT16	Register	1	03	06
4203	Maximum grid current RMS L1 (charging and discharging)	A	0.01	8000	0	8000	UINT16	Register	1	03	06
4204	Maximum grid current RMS L2 (charging and discharging)	A	0.01	8000	0	8000	UINT16	Register	1	03	06
4205	Maximum grid current RMS L3 (charging and discharging)	A	0.01	8000	0	8000	UINT16	Register	1	03	06
4206	Set value cos phi L1	-	0.01	100	-100	100	INT16	Register	1	03	06
4207	Set value cos phi L2	-	0.01	100	-100	100	INT16	Register	1	03	06
4208	Set value cos phi L3	-	0.01	100	-100	100	INT16	Register	1	03	06
4213	Phase L1 inductive/capacitive (TRUE = capacitive)	-	1.0	1	0	1	UINT16	Coil	1	01	05
4214	Phase L2 inductive/capacitive (TRUE = capacitive)	-	1.0	1	0	1	UINT16	Coil	1	01	05
4215	Phase L3 inductive/capacitive (TRUE = capacitive)	-	1.0	1	0	1	UINT16	Coil	1	01	05
4216	Phases are inductive/capacitive (TRUE = capacitive)	-	1.0	1	0	1	UINT16	Coil	1	01	05
4217	Set value cos phi for L1-L3	-	0.01	100	-100	100	INT16	Register	1	03	06
4218	Set value sin phi L1-L3	-	0.01	0	-100	100	INT16	Register	1	03	06

Addr	Description	Unit	Resolution	Default	Min	Max	Data type	Type	Length	FCr	FCw
4219	Set value sin phi L1	-	0.01	0	-100	100	INT16	Register	1	03	06
4220	Set value sin phi L2	-	0.01	0	-100	100	INT16	Register	1	03	06
4221	Set value sin phi L3	-	0.01	0	-100	100	INT16	Register	1	03	06
4222	Frequency offset in island operation	Hz	0.01	0	-500	500	INT16	Register	1	03	06
4223	Voltage adjustment factor in island operation	%	1.0	100	75	120	UINT16	Register	1	03	06
4224	Set value for balancer controller, for voltage difference (pos - neg) of internal DC-Bus voltages.	V	0.01	0	-15000	15000	INT16	Register	1	03	06
4225	Voltage reserve of DC link at pre-charge	V	1.0	10	-10		INT16	Register	1	03	06
4226	max. instantaneous current (pos/neg) L1 (in grid-forming mode)	A	0.01	12500	0	15000	UINT16	Register	1	03	06
4227	max. instantaneous current (pos/neg) L2 (in grid-forming mode)	A	0.01	12500	0	15000	UINT16	Register	1	03	06
4228	max. instantaneous current (pos/neg) L3 (in grid-forming mode)	A	0.01	12500	0	15000	UINT16	Register	1	03	06
4229	Voltage source mode, grid-forming: 0 = not grid-forming (grid-following) 1 = grid-forming	-	1.0	1	0	1	UINT16	Register	1	03	06
4230	DC link reference voltage 380/400V grid	V	0.1	8500	6000	9500	UINT16	Register	1	03	06
4231	DC link min voltage 380/400V grid	V	0.1	8300	6000	9500	UINT16	Register	1	03	06
4232	DC link max voltage 380/400V grid	V	0.1	8700	6000	9600	UINT16	Register	1	03	06
4233	DC link reference voltage 480V grid	V	0.1	9000	6000	9500	UINT16	Register	1	03	06
4234	DC link min voltage 480V grid	V	0.1	8800	6000	9500	UINT16	Register	1	03	06
4235	DC link max voltage 480V grid	V	0.1	9200	6000	9600	UINT16	Register	1	03	06
4236	Frequency slope in function $f_N = f(\text{active grid power})$ of droop control in island operation.	%	0.01	200	10	400	UINT16	Register	1	03	06
4237	Voltage slope in function $V_N = f(\text{reactive grid power})$ of droop control in island operation.	%	0.01	500	10	1000	UINT16	Register	1	03	06

Addr	Description	Unit	Resolution	Default	Min	Max	Datatype	Type	Length	FCr	FCw
4238	Maximum (positive) difference frequency of the linearization point above the nominal frequency in combined controller mode (parameter for the statics controller).	Hz	0.01	250	-600	600	INT16	Register	1	03	06
4239	Maximum (negative) difference frequency of the linearization point below the nominal frequency in combined controller mode (parameter for the statics controller).	Hz	0.01	-250	-600	600	INT16	Register	1	03	06
4240	Factor for the maximum voltage of the linearization point with respect to the nominal voltage in combined controller mode (parameter for the statics controller).	%	1.0	115	75	120	UINT16	Register	1	03	06
4241	Factor for the minimum voltage of the linearization point with respect to the nominal voltage in combined controller mode (parameter for the statics controller).	%	1.0	85	75	120	UINT16	Register	1	03	06
4242	Max Time until the controller starts to control after closing the relay	ms	1.0	100	0	10000	UINT16	Register	1	03	06
4243	Voltage at which the droop control function delivers the maximum possible intervention due to maximum DC-bus voltage. Value applies to grids with voltages greater than 440 V (US grid).	V	0.1	9500	6000	9600	UINT16	Register	1	03	06
4244	Voltage at which the droop control function starts to intervene due to a too high DC link voltage. Value applies to grids with voltages greater than 440 V (US grid).	V	0.1	9150	6000	9590	UINT16	Register	1	03	06
4245	Voltage at which the droop control function starts to intervene due to a too low DC link voltage. Value applies to grids with voltages greater than 440 V (US grid).	V	0.1	8850	6000	9500	UINT16	Register	1	03	06

Addr	Description	Unit	Resolution	Default	Min	Max	Data type	Type	Length	FCr	FCw
4246	Voltage at which the droop control function delivers the maximum possible intervention due to minimum DC-bus voltage. Value applies to grids with voltages greater than 440 V (US grid).	V	0.1	8500	600 0	949 0	UINT16	Register	1	03	06
4247	Voltage at which the droop control function delivers the maximum possible intervention due to maximum DC-bus voltage. Value applies to grids with voltages lower than 440 V (no US grid).	V	0.1	9300	600 0	960 0	UINT16	Register	1	03	06
4248	Voltage at which the droop control function starts to intervene due to a too high DC link voltage. Value applies to grids with voltages lower than 440 V (no US grid).	V	0.1	8700	600 0	959 0	UINT16	Register	1	03	06
4249	Voltage at which the droop control function starts to intervene due to a too low DC link voltage. Value applies to grids with voltages lower than 440 V (no US grid).	V	0.1	8300	600 0	950 0	UINT16	Register	1	03	06
4250	Voltage at which the droop control function delivers the maximum possible intervention due to minimum DC-bus voltage. Value applies to grids with voltages lower than 440 V (no US grid).	V	0.1	7500	600 0	949 0	UINT16	Register	1	03	06
4251	Time constant for the DC-bus droop control function.	ms	1.0	33	1	500 00	UINT16	Register	1	03	06
4252	HB PWM ON(=2); AUTOMATIC(=1); OFF(=0)	-	1.0	1	0	2	UINT16	Register	1	03	06
4253	Gain factor for controlling the influence of the "symmetration/asymmetration from grid" (0..1).		0.01	100	0	100	UINT16	Register	1	03	06
4280	Sets the output power to S = 0 kVA. Only available for some grid code functions.	-	1.0	0	0	1	UINT16	Register	1	03	06
4281	maximum P, controllable by VNB via ModBus. 100 % is equivalent to Smax * OLC (e.G. 25000 * 1,5 = 37500)	W	0.01	15000	0	200 00	UINT16	Register	1	03	06

Addr	Description	Unit	Resolution	Default	Min	Max	Data type	Type	Length	FCr	FCw
4282	Activates a startup ramp. Only available for some grid code functions.	-	1.0	0	0	1	UINT16	Register	1	03	06
4300	Configuration DC stage: 0 = DC module is off, power electronic circuit is deactivated, battery voltage can be measured. 1 = DC module is active (DC link voltage control) 2 = DC module is active (current source mode or in DC droop mode)	-	1.0	1	0	2	UINT16	Register	1	03	06
5000	State of device: PowerUP -> 0, Error -> 1, Idle -> 2, Operation -> 3, Maintenance -> 4	-	1.0	-1	-2	10	INT16	Register	1	04	
5001	Number of connected slave modules	cnt	1.0	0		16	UINT16	Register	1	04	
5002	Number of connected sub slave modules	cnt	1.0	0	0	5	UINT16	Register	1	04	
5020	Nominal grid frequency	Hz	0.1	500			UINT16	Register	1	04	
5021	Nominal grid voltage	V	1.0	400			UINT16	Register	1	04	
5022	Nominal apparent power capability	VA	1.0	25000			UINT16	Register	1	04	
5023	Active grid type: 0 = grid-tied, 400V, 50Hz 1 = grid-tied, 480V, 60Hz 2 = island mode, 400V, 50Hz 3 = island mode, 480V, 60Hz 4 = grid-tied, 380V, 60Hz	-	1.0	0	0		UINT16	Register	1	04	
5024	Status of power limiting controller 0 = inactive, 1 = DC link limiting controller active 2 = grid code limiting active 3 = overload limiting active 4 = temperature derating active		1.0	0	0	10	UINT16	Register	1	04	
5025	Active DC link reference voltage	V	0.1	0	600 0	950 0	UINT16	Register	1	04	

Addr	Description	Unit	Resolution	Default	Min	Max	Data type	Type	Length	FCr	FCw
5026	Active DC link min voltage	V	0.1	0	600 0	950 0	UINT16	Register	1	04	
5027	Active DC link max voltage	V	0.1	0	600 0	960 0	UINT16	Register	1	04	
5028	Voltage threshold of DC link half	V	0.01	0	0	500 00	UINT16	Register	1	04	
5029	Active voltage source mode, grid-forming: 0 = not grid-forming (grid-following) 1 = grid-forming	-	1.0	1	0	1	UINT16	Register	1	04	
5030	State inverter: 0 = Idle 1 = DC link internal test 2 = DC synchronize to external voltage 3 = DC link charge 4 = AC synchronize to external voltage 5 = AC close mains contactor 6 = AC connected 7 = AC open mains contactor 99 = Alarm 100 = Parameter not valid for chosen module		1.0	100	0	100	UINT16	Register	1	04	

Addr	Description	Unit	Res olu- tion	Default	Min	Max	Dat atyp e	Typ e	Len gth	FCr	FCw
5031	Indicates the source of the alarm event: 0 = Idle state 1 = DC link internal test state 2 = DC synchronize to external voltage state 3 = DC link charge state 4 = AC synchronize to external voltage state 5 = AC close mains contactor state 6 = AC connected state 7 = AC open mains contactor state 99 = Alarm state 100 = No alarm present or parameter not valid for chosen module 101 = RS-485 master		1.0	100	0	101	UIN T16	Regi ster	1	04	
5032	Voltage at which the droop control function delivers the maximum possible intervention due to maximum DC-bus voltage.	V	0.1	0	600 0	960 0	UIN T16	Regi ster	1	04	
5033	Voltage at which the droop control function starts to intervene due to a too high DC link voltage.	V	0.1	0	600 0	959 0	UIN T16	Regi ster	1	04	
5034	Voltage at which the droop control function starts to intervene due to a too low DC link voltage.	V	0.1	0	600 0	950 0	UIN T16	Regi ster	1	04	
5035	Voltage at which the droop control function delivers the maximum possible intervention due to minimum DC-bus voltage.	V	0.1	0	600 0	950 0	UIN T16	Regi ster	1	04	
5037	Maximum possible voltage adjustment factor given by the available DC link voltage halves (for voltage regulation).	%	1.0	110			UIN T16	Regi ster	1	04	
5038	Voltage adjustment factor	%	1.0	100			UIN T16	Regi ster	1	04	
5130	Apparent power L1	kVA	0.00 1		0		UIN T16	Regi ster	1	04	

Addr	Description	Unit	Resolution	Default	Min	Max	Datatype	Type	Length	FCr	FCw
5131	Apparent power L2	kVA	0.001		0		UINT16	Register	1	04	
5132	Apparent power L3	kVA	0.001		0		UINT16	Register	1	04	
5133	Overload capacity L1	%	0.1	0	0	1000	UINT16	Register	1	04	
5134	Overload capacity L2	%	0.1	0	0	1000	UINT16	Register	1	04	
5135	Overload capacity L3	%	0.1	0	0	1000	UINT16	Register	1	04	
5140	Active power L1 with corrected sign	kW	0.001				INT16	Register	1	04	
5141	Active power L2 with corrected sign	kW	0.001				INT16	Register	1	04	
5142	Active power L3 with corrected sign	kW	0.001				INT16	Register	1	04	
5150	Grid current RMS L1	A	0.01		0	8800	UINT16	Register	1	04	
5151	Grid current RMS L2	A	0.01		0	8800	UINT16	Register	1	04	
5152	Grid current RMS L3	A	0.01		0	8800	UINT16	Register	1	04	
5160	Grid voltage RMS L1	V	0.1		0	3100	UINT16	Register	1	04	
5161	Grid voltage RMS L2	V	0.1		0	3100	UINT16	Register	1	04	
5162	Grid voltage RMS L3	V	0.1		0	3100	UINT16	Register	1	04	
5170	cos phi L1	-	0.01		-100	100	INT16	Register	1	04	
5171	cos phi L2	-	0.01		-100	100	INT16	Register	1	04	
5172	cos phi L3	-	0.01		-100	100	INT16	Register	1	04	
5180	Sum apparent power L1	kVA	0.001				UINT32	Register	2	04	
5182	Sum apparent power L2	kVA	0.001				UINT32	Register	2	04	
5184	Sum apparent power L3	kVA	0.001				UINT32	Register	2	04	
5186	Sum power L1	kW	0.001				INT32	Register	2	04	
5188	Sum power L2	kW	0.001				INT32	Register	2	04	
5190	Sum power L3	kW	0.001				INT32	Register	2	04	
5200	Grid frequency (If outside of 45-65Hz range or Vg_rms below 35 V, -1 will be prompted.)	Hz	0.01	0	-100	7000	INT16	Register	1	04	

Addr	Description	Unit	Resolution	Default	Min	Max	Data type	Type	Length	FCr	FCw
5210	Intern DC link voltage upper half	V	1.0	0	0	1100	UINT16	Register	1	04	
5211	Intern DC link voltage lower half	V	1.0	0	0	1100	UINT16	Register	1	04	
5212	Extern DC link voltage upper half	V	1.0	0	0	1100	UINT16	Register	1	04	
5213	Extern DC link voltage lower half	V	1.0	0	0	1100	UINT16	Register	1	04	
5220	Voltage internal N to PE	V	0.1	0			INT16	Register	1	04	
5221	Voltage external N to PE	V	0.1	0			INT16	Register	1	04	
5231	Reactive Power L1 with corrected sign	kVAr	0.001				INT16	Register	1	04	
5232	Reactive Power L2 with corrected sign	kVAr	0.001				INT16	Register	1	04	
5233	Reactive Power L3 with corrected sign	kVAr	0.001				INT16	Register	1	04	
5234	Sum Reactive Power L1	kVAr	0.001				INT32	Register	2	04	
5236	Sum Reactive Power L2	kVAr	0.001				INT32	Register	2	04	
5238	Sum Reactive Power L3	kVAr	0.001				INT32	Register	2	04	
5500	Inlet air temperature	°C	0.1	0			INT16	Register	1	04	
5501	Temperature sensor for IGBT module L1	°C	0.1	0			UINT16	Register	1	04	
5502	Temperature sensor for IGBT module L2	°C	0.1	0			UINT16	Register	1	04	
5503	Temperature sensor for IGBT module L3	°C	0.1	0			UINT16	Register	1	04	
5504	Temperature sensor for IGBT balancer module	°C	0.1	0			UINT16	Register	1	04	
5505	Fan revolutions per minute	rpm	1.0				UINT16	Register	1	04	
2401	Sum of all pending warnings	Count			0		UINT16	Register	1	04	
2402	Count of pending module specific warnings	Count					UINT16	Register	1	04	
2403	Warning code of alarm 1						UINT16	Register	1	04	
2404	Warning code of alarm 2						UINT16	Register	1	04	
2405	Warning code of alarm 3						UINT16	Register	1	04	
2406	Warning code of alarm 4						UINT16	Register	1	04	
2407	Warning code of alarm 5						UINT16	Register	1	04	

Addr	Description	Unit	Resolu- tion	Default	Min	Max	Dat atyp e	Typ e	Len gth	FCr	FCw
2408	Warning code of alarm 6						UIN T16	Regi ster	1	04	
2409	Warning code of alarm 7						UIN T16	Regi ster	1	04	
2410	Warning code of alarm 8						UIN T16	Regi ster	1	04	
2411	Warning code of alarm 9						UIN T16	Regi ster	1	04	
2412	Warning code of alarm 10						UIN T16	Regi ster	1	04	
2413	Warning code of alarm 11						UIN T16	Regi ster	1	04	
2414	Warning code of alarm 12						UIN T16	Regi ster	1	04	
2415	Warning code of alarm 13						UIN T16	Regi ster	1	04	
2416	Warning code of alarm 14						UIN T16	Regi ster	1	04	
2417	Warning code of alarm 15						UIN T16	Regi ster	1	04	
2418	Warning code of alarm 16						UIN T16	Regi ster	1	04	
2419	Warning code of alarm 17						UIN T16	Regi ster	1	04	
2420	Warning code of alarm 18						UIN T16	Regi ster	1	04	
2421	Warning code of alarm 19						UIN T16	Regi ster	1	04	
2422	Warning code of alarm 20						UIN T16	Regi ster	1	04	
2808	Sum of all pending alarms	Cou nt			0		UIN T16	Regi ster	1	04	
2809	Count of pending module specific alarms	Cou nt					UIN T16	Regi ster	1	04	
2810	Alarm code of alarm 1						UIN T16	Regi ster	1	04	
2811	Alarm code of alarm 2						UIN T16	Regi ster	1	04	
2812	Alarm code of alarm 3						UIN T16	Regi ster	1	04	
2813	Alarm code of alarm 4						UIN T16	Regi ster	1	04	
2814	Alarm code of alarm 5						UIN T16	Regi ster	1	04	
2815	Alarm code of alarm 6						UIN T16	Regi ster	1	04	
2816	Alarm code of alarm 7						UIN T16	Regi ster	1	04	
2817	Alarm code of alarm 8						UIN T16	Regi ster	1	04	

Addr	Description	Unit	Res olu- tion	Default	Min	Max	Dat atyp e	Typ e	Len gth	FCr	FCw
2818	Alarm code of alarm 9						UIN T16	Regi ster	1	04	
2819	Alarm code of alarm 10						UIN T16	Regi ster	1	04	
2820	Alarm code of alarm 11						UIN T16	Regi ster	1	04	
2821	Alarm code of alarm 12						UIN T16	Regi ster	1	04	
2822	Alarm code of alarm 13						UIN T16	Regi ster	1	04	
2823	Alarm code of alarm 14						UIN T16	Regi ster	1	04	
2824	Alarm code of alarm 15						UIN T16	Regi ster	1	04	
2825	Alarm code of alarm 16						UIN T16	Regi ster	1	04	
2826	Alarm code of alarm 17						UIN T16	Regi ster	1	04	
2827	Alarm code of alarm 18						UIN T16	Regi ster	1	04	
2828	Alarm code of alarm 19						UIN T16	Regi ster	1	04	
2829	Alarm code of alarm 20						UIN T16	Regi ster	1	04	

Modbus

Tab. 28

7.5 Transmission of power

Switching the transmission of power on/off

Conditions

- Initial commissioning was performed ([see "Commissioning", pg. 63](#)).
- Operation via web GUI and/or Modbus.

Note

User interface and Modbus may have different scaling. For Modbus parameters, the resolutions specified in the Modbus Register Map must be taken into account ([see "Modbus Register Map", pg. 77](#)).

For example:

Enter 100 A for parameter "Max. charging current, DC module 1" with resolution 0.1:

Input via web GUI: 100.0

Transfer via Modbus: 1000.

Selecting an AC-DC module

1. Selection of an AC-DC module (only relevant if multiple modules are connected to a TruConvert System Control).
 - Select *>Operation >Device control AC-DC mode*.
 - In the "Module selection" area under "Select slave module", select a module.
 - Modbus: Enter the number of the module to be addressed (see "Tab. 28", pg. 91).

Entering process set values: S, cos(φ), phase position

The set value specification differs depending on the installation location of the system and the thereby selected grid code. Thus, a set value specification of S, cosPhi and phase position is possible in some regions while a set value specification of P and Q is possible in others.

2. Enter set value for the apparent power in kVA:
 - Select *>Operation >Device control AC-DC mode*.
 - In the "Device control AC-DC" section under "Apparent power AC", enter the value¹⁰.
 - Press key \downarrow .
3. For "Power factor cos(φ)", enter:
 - Value between: -1 to +1 (in increments of 0.01)¹². Press key \downarrow .
 - Modbus: Value between: -100 to +100 (in increments of 1).
 - Note the selected reference arrow system and set the sign accordingly.
4. Under "Phase position", select:
 - "inductive" (default setting)
 - "capacitive"

Entering process set values: P and Q

5. Enter set value for the effective power in kW:
 - Select *>Operation >Device control AC-DC mode*.
 - In the "Device control AC-DC" section under "Active power AC", enter the value¹¹.
 - Press key \downarrow .
 - Note the selected reference arrow system and set the sign accordingly.
6. Enter set value for the reactive power in kVAr:
 - Under "Reactive power AC", enter the value¹². Press key \downarrow .
 - Note the selected reference arrow system and set the sign accordingly.

10 In the user interface, a period character is used as the decimal separator.

11 In the user interface, a period character is used as the decimal separator.

12 In the user interface, a period character is used as the decimal separator.

If no reactive power Q can be entered:

A setting has been selected in the grid codes that does not permit the manual entry of the value.

- Only enter the set value for the effective power P.
- (see supplement to the "TruConvert System Control, Grid Codes" operator's manual)

Changing process set values: S and cos(φ) ⇔ P and Q

Depending on the installation location of the system and the thereby selected grid code, it may be possible to switch between the two input forms for process set values.

7. Selecting input forms for process set values:
 - Select *>Operation >Device control AC-DC mode*.
In the "Device control settings AC-DC" section, select the desired input form under "Power setpoint type".
 - Press key ↵.

Precharging DC link voltage

8. In the "Device control settings AC-DC" area under "DC link precharge config", set from which side the DC link voltage is to be precharged:

Web GUI	Mod-bus register 4005	Description
	Bit	
external	0	Device is waiting for external precharging of the DC link.
internal	1	Device is charging the DC link to the required voltage.
internal with DC module	2	Setting similar to "internal" with support of the DC-DC modules (required in isolated mode).
internal & wait	3	Device is charging the DC link to the required voltage and is waiting until "DC link precharge config" is set back to "internal" or "internal with DC module" in order to connect to the AC grid.

Tab. 29

Start transmission of power

9. Start transmission of power:
 - Select *>Operation >Device control AC-DC mode*.
Under "Activate power stage": click on the slide control.
 - Modbus: Register for power operation, set bit = 1 (see "Tab. 28", pg. 91).

The regulator slides to the right and is displayed in blue.

Stop transmission of power

10. To stop the transmission of power:

Starting/stopping power transmission for other AC-DC modules

- Under "Activate power stage": click on the slide control..
 - Modbus: Register for power operation, set bit = 0 (see "Tab. 28", pg. 91).
11. Starting/stopping power transmission for other AC-DC modules
- Select another AC-DC module (via user interface or slave address via Modbus) and perform the previous steps again.
- or**
- To switch on all AC-DC modules simultaneously:
 - In the "Module selection" section under "Select slave module", select = "All modules".
 - Modbus: Enter the number of the slave to be addressed = "0".
 - Start transmission of power.

Simultaneously changing set values for power transfer

By default, each set value change is applied immediately. This can result in undesired intermediate states until all new set values have been entered. This can be avoided by using function "Activate power setpoint trigger". First, all three set values can be entered for the power transfer ("Apparent power AC", "Power factor $\cos(\varphi)$ ", "Phase position"). The changed set values are then adopted at the same time.

12. To transfer the set values simultaneously:

- In the "Device control settings AC-DC" section under "Activate power setpoint trigger": click on the slide control..
- The "Send power setpoints" button appears in the "Device control AC-DC" section.
- Enter the new set values in the "Device control AC-DC" section.
 - Click on "Send power setpoints".
- or**
- Modbus:
 - Register 4182 "Activate power setpoint trigger": Set bit = 1.
 - In the registers for the set values: Enter the new set values.
 - Register 4183 "Send power setpoints" Set bit = 1.



7.6 Displaying and resetting messages

Displaying messages of the web GUI

There are various options for reading the pending messages:

- Status bar: type and number of pending messages, .
- "Message History" Main menu, (see "Orientation of the user interface", pg. 70): type, code, module, date/time.
- Expandable sidebar: type, number, code, module, date/time and message text.

Displaying messages

If a message is pending, the icon for messages in the sidebar  is colored orange or red . If there are any warnings present, the icon is orange. If at least one alarm is pending, the icon is colored red.

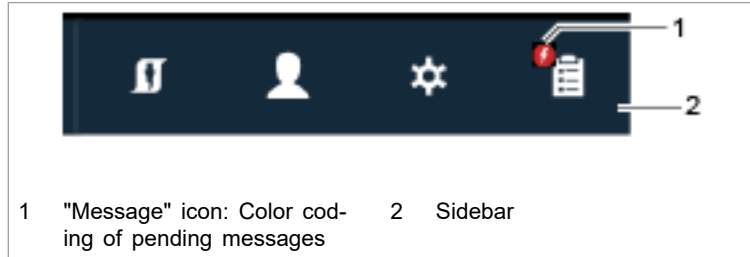

1 "Message" icon: Color coding of pending messages

2 Sidebar

Fig. 49

1. In the sidebar, click on the  icon to display the messages.

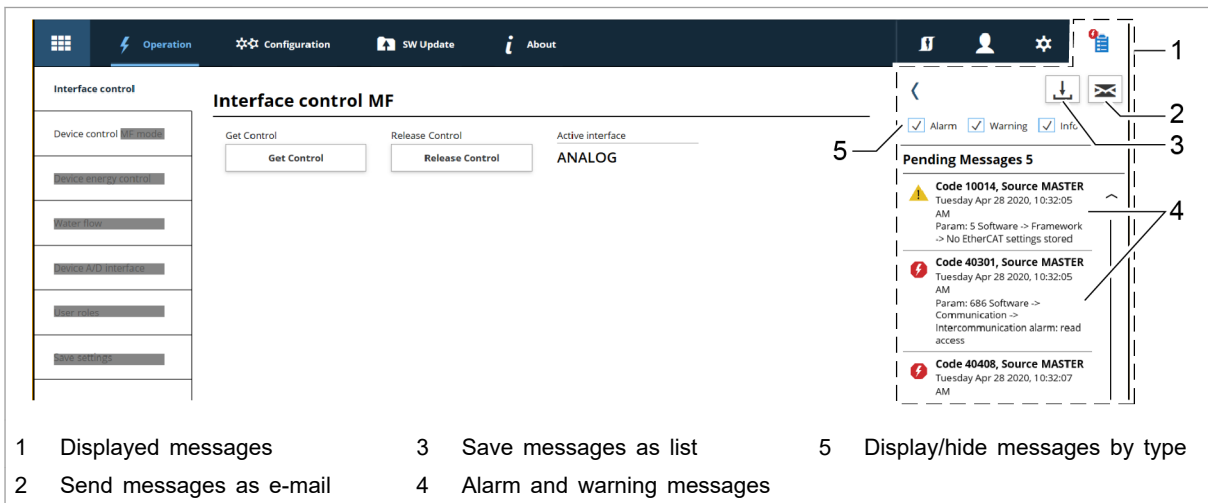

1 Displayed messages

3 Save messages as list

5 Display/hide messages by type

2 Send messages as e-mail

4 Alarm and warning messages

Sidebar, expanded

Fig. 50

A message consists of 3 components: "Code" (message number), "Source" (originator) and message text.

- The module that has caused the message is indicated by the description and number in the "Source" field.

MASTER = System control

- SLAVE = AC-DC module

Each slave number has 4 digits. The first 2 digits stand for the slave modules (AC-DC modules) connected to the system control, and the 3rd and 4th digits stand for the subslave modules (DC-DC modules).

Example:

Source: Slave 0204 → A subslave 04 (DC-DC module) is connected to slave 02 (AC-DC module). DC-DC module number 4 has caused the message.

- If TRUMPF Service is to be contacted, it is recommended to note down the message number.

Tip

To display the window of the sidebar larger: click on the  arrow.

To hide the window of the sidebar: click on the active icon again.

- Download alarm list**
- To download a list of all alarm messages that have occurred:
 - Press the "Meldungen als Liste speichern" (3) button.
 - Save as a csv file.
 - To generate a prepared e-mail to TRUMPF Service:
 - Press the "Meldungen als E-Mail verschicken" (2) button.
 - Press "Save " download to save the zip file on the PC.
 - The e-mail program opens and displays a prepared e-mail.
 - Attach the zip file saved under *>Downloads* on the PC.

- Reset messages**
- In the sidebar, click on the  icon to display the messages.
 - Press "Reset".
- The icon turns white again. All messages are reset.
- Hide messages:

To hide the window of the sidebar: click on the active icon again.

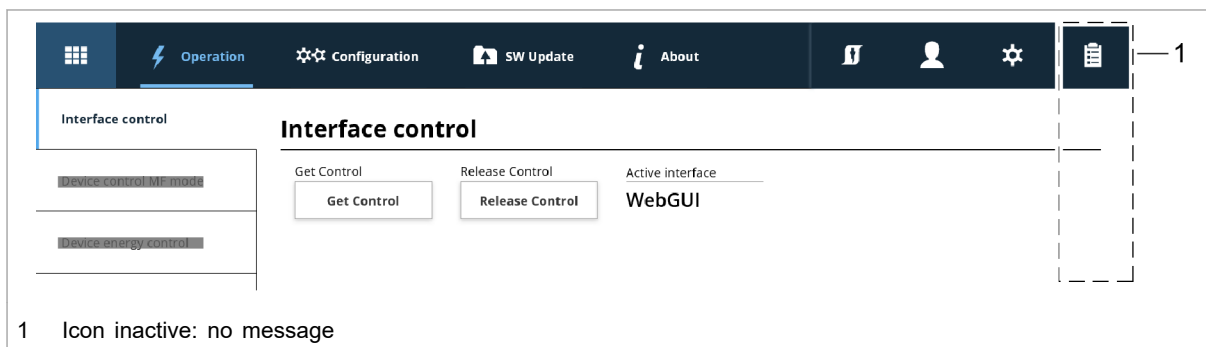

Sidebar, collapsed, no messages

Fig. 51

- To reset the messages of a specific module:

- Select >Operation >Device control DC-DC mode.
- In the "Module selection" area under "Select slave module", select a module.
- In the "Device control DC-DC" section, press "Reset alarms".

All messages of the selected module are reset.

If the message is not reset:

- If MASTER is displayed under "Source", select "All modules" under "Select slave module". All messages are reset, including the messages from the master (system control).
- If SLAVE 1 is display under "Source", select "Module 1" under "Slave module selection" in order to reset only the messages from slave 1 and its subslaves.

Modbus: displaying and resetting messages

Two types of message types are used: alarm, warning.

The number of pending messages can be queried by message type and the message numbers read out.

Displaying the number of all pending messages

1. Read out the number of current alarm/warning messages that have occurred on the entire system:
 - Sum of the alarm messages: register 2808
 - Sum of the warning message: register 2401
 - (see "Tab. 28", pg. 91)

The number of all messages that occurred in the system is output.

Displaying the number of messages pending on the selected module

2. Read out the number of current alarm/warning messages that have occurred on the selected module:
 - Sum of the alarm messages: register 2809
 - Sum of the warning messages: register 2402

The number of all messages that have occurred on the selected module is output.

Reading out message numbers

3. Read out message numbers (alarm/warning messages 1 to 20) that have occurred on the selected module:

- Alarm messages: registers 2810 – 2829
- Warning message: registers 2403 – 2422
- The corresponding message number is stored in each register.

All message numbers that have occurred at the selected module are stored in these register areas as a kind of overview list. The message numbers are stored in the order in which they occurred (e.g., alarm message 1 in register 2810, alarm message 2 in register 2811, etc.). The corresponding texts are listed in the message table (see "Messages", pg. 131).

Reset messages

4. Reset messages:
 - Select the desired module (see "Addressing modules via Modbus registers 4007 and 4010", pg. 76).
 - Modbus: (see "Tab. 28", pg. 91)

For Modbus register 4002, set "Alarm reset" bit = 1.

All messages are reset. No further messages are pending.

If the cause of a message persists, this message is displayed again.

7.7 Overload

To permit load peaks when starting up motors or when starting devices, the modules can be operated in overload operation. This method of operation is permissible only for a short time and is regulated accordingly by the system.

The overload is monitored and regulated separately for each phase.

Operating with overload

Note

Overload operation is possible only in the following ambient temperature ranges:

- Charging: -5°C to 35°C.
- Discharging: -5°C to 40°C.

Via user interface

1. *>Operation >Device control AC-DC mode* under "Apparent power AC":

Increase the maximum values for the apparent power.

Increase the apparent power up to max. 37.5 kVA.

2. Start transmission of power.

As soon as a higher phase current and AC power that is higher than the nominal apparent power is called, the system can supply this for a certain time span.

Status AC module(s)				
Internal DC link voltage +	Internal DC link voltage -	External DC link voltage +	External DC link voltage -	
0 V	0 V	0 V	0 V	
Phase voltage L1	Current L1	Apparent power L1	Active power L1	Reactive power L1
230.0 V	0.00 A	0.00 kVA	0.00 kW	0.00 kVAr
Overload capacity L1	1			
100.0 %				
Phase voltage L2	Current L2	Apparent power L2	Active power L2	Reactive power L2
230.0 V	0.00 A	0.00 kVA	0.00 kW	0.00 kVAr
Overload capacity L2	2			
100.0 %				
Phase voltage L3	Current L3	Apparent power L3	Active power L3	Reactive power L3
230.0 V	0.00 A	0.00 kVA	0.00 kW	0.00 kVAr
Overload capacity L3	3			
100.0 %				

1 Overload capacity L1 2 Overload capacity L2 3 Overload capacity L3

Status display for the overload capacity (user interface)

Fig. 52

The overload capacities are displayed in the "Status AC module(s)" section.

During overload operation, the overload capacity is reduced continuously. The still remaining overload capacity is displayed on the user interface in percent. As soon as the overload capacity has dropped to "0%", only operation at nominal apparent power is possible.

Exception:

In grid-forming mode (see "Operation with voltage regulation (grid-forming or grid-following mode)", pg. 106), the formed grid cannot be sustained with an overload capacity of "0 %". The device switches off with a corresponding message. In addition, a message is displayed regarding overcurrent on the respective phase.

To restore the overload capacity, the AC-DC module must be operated for a period of time at less than 90% or less than 80% of the nominal power.

Via the Modbus

- Increase the maximum values for the apparent power.
Modbus registers 5130/5131/5132 "Apparent power Lx".
Modbus: (see "Tab. 28", pg. 91)
- Start transmission of power.

Set Modbus register 4000 "Power stage configuration" bit = 1.

5. Read out overload capacities.

Modbus registers 5133/5134/5135 "Overload capacity Lx".

Examples: Reduce and then again increase overload capacity

Reduce overload capacity from 100% to 0%

The overload capacity drops from 100% to 0% if the system is operated at overload with:

- AC power set value between 100% and 125%.
For 10 minutes.
- or
- AC power set value between 125% and 150%.
For 1 minute.

Increase overload capacity again from 0% to 100%

The overload capacity increases again from 0% to 100% if the system is operated under normal load with:

- AC power set value of <90%.
For 20 minutes.
- or
- AC power set value of <80%.
For 10 minutes.

7.8 Actual values

Display actual values

Display AC values

- Display the current values at the grid connection of the AC-DC module.
 - Select *>Operation >Device control AC-DC mode*.
In the "Module selection" section under "Select slave module", select the desired module. Or select "All modules" in order to display the generally applicable or sum values of all modules (0 is displayed in the case of values that cannot be summed).
Read the actual values in the "Status AC module(s)" section.
 - Modbus: (see "Tab. 28", pg. 91)
Read actual value.

7.9 Process set values

Set process set values

- Set the process set values via the web GUI: (see "Set process set values (AC-DC module settings)", pg. 65).

or

- Set the process set values via Modbus registers: (see "Tab. 28", pg. 91).

7.10 DC link

The parameters set at the factory are suitable for the majority of applications. For energy storage systems that are directly connected to the DC link, it can be useful to adjust these settings.

The possible settings for the DC link differ depending on the selected regulator type: voltage regulation or mains current regulation. Depending on the regulator type, the DC link voltage is influenced in different ways.

Setting DC link with "voltage regulation" regulator type

The effective power on the grid side is controlled using an adjustable "droop characteristic curve" depending on the DC link voltage.

All values on the x-axis are adjustable parameters (see "Tab. 30", pg. 104).

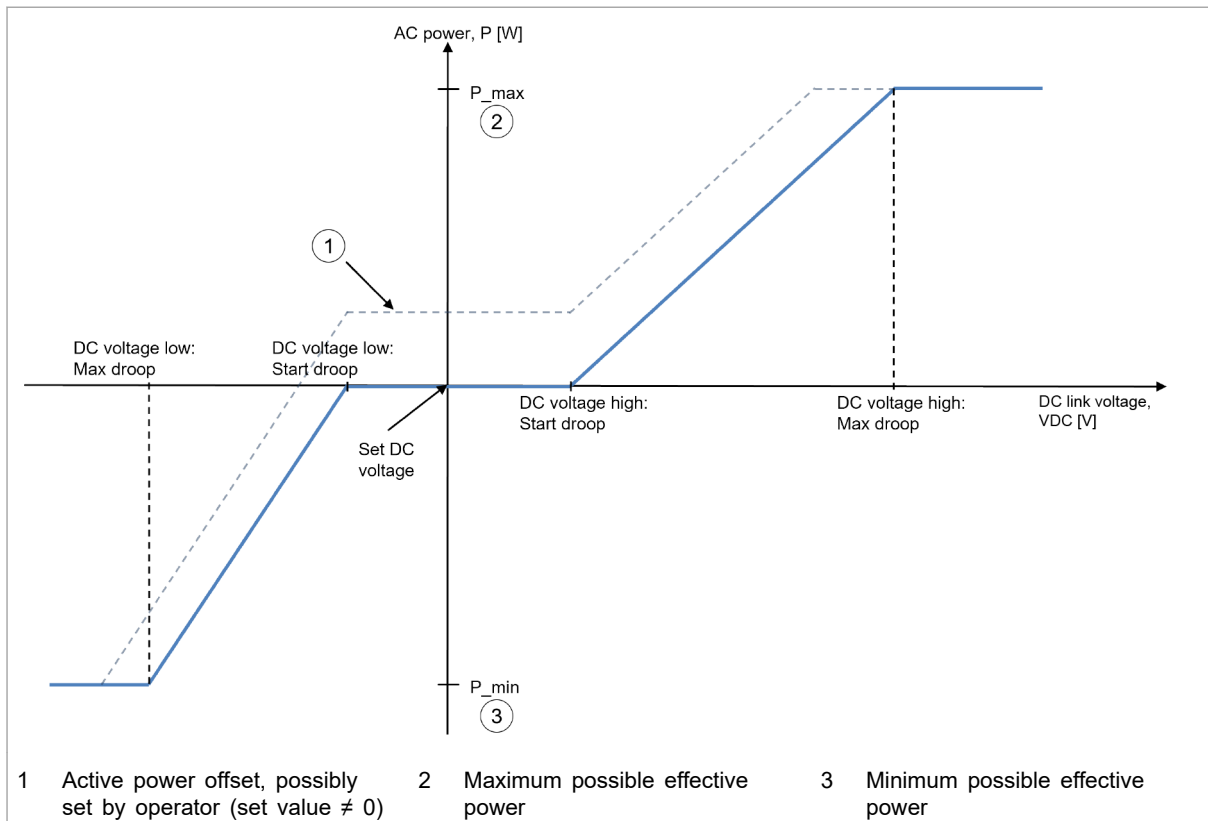

Droop characteristic curve, $P = f(VDC)$

Fig. 53

The "droop control" influences the set value for effective power using the internal AC droop that acts on the power regulation of the system. The maximum possible dynamics for "droop control" are therefore below the underlying AC droop with power regulation. Other information, (see "Operation with voltage regulation (grid-forming or grid-following mode)", pg. 106).

The adjustable parameters directly influence the slope of the "droop characteristic curve" and therefore also its gain. The gain in turn influences the dynamic behavior. A large slope (high kW/VDC) means a high gain.

Furthermore, the dynamic behavior is also influenced by the structure of the DC busbar which is connected to the DC link. The behavior of the connected participants as well as their quantity can vary.

For these reasons, not every combination of DC busbar and droop characteristic parameter settings form a stable system.

The parameters set at the factory are suitable for the majority of applications.

The parameters can be changed if required. The system stability must then be checked for the individual case in question.

If the DC busbar voltage is predetermined by external devices or devices provided by the customer or if influence by the Tru-Convert AC 3025 is not desired, the parameters can be set in such a way that "droop control" only acts outside of the desired voltage window. In this case, the operations management must ensure that the necessary DC busbar voltage is available in order to prevent unwanted shutdowns.

- Via user interface**
1. Select *>Operation >AC-DC module settings*.
 2. To set the parameters for this function:
 - Enter the desired values in the "DC link settings" section.

Parameter description: (see "Tab. 30", pg. 104).

The adopted and, thus, active values are displayed below the input fields.

- Via the Modbus**
3. To set the parameters for this function:
 - In register area 4230 – 4250, enter the desired values.
- Parameter description: (see "Tab. 30", pg. 104).

All adjustable parameters are listed in the following table.

Parameter**	Description
DC voltage low: Max droop Register 4250 Register 4246	<p>With this voltage value, the maximum negative effective power is added to the power set value. This counteracts the drop in DC link voltage.*</p> <p>Note</p> <p>The value must be greater than twice the grid voltage amplitude. Otherwise, the entry is ignored.</p> <p>Example for a 400 V grid: $\sqrt{\frac{2}{3}} \times 400 V \times 2 = 654 V$</p> <p>The measured grid voltage amplitude is displayed in the same section under "Voltage threshold of DC link half".</p>
DC voltage low: Start droop Register 4249 Register 4245	<p>With this voltage value, the "droop control" begins to request negative effective power. This counteracts the drop in DC link voltage.*</p>
Set DC voltage Register 4230 Register 4233	<p>If further DC-DC modules are connected to the AC-DC module and if in the "active" operating state, the set value of the DC link voltage can be set here.*</p> <p>Querying the operating state of the DC-DC modules:</p> <ul style="list-style-type: none"> ▪ Select <i>>Operation >DC-DC module settings</i>. ▪ In the "Module selection" section under "Select slave module", select "All modules". ▪ Read the current status in the "Slave module status" section under "Status DC module".

Parameter**	Description
DC voltage high: Start droop Register 4248 Register 4244	With this voltage value, the "droop control" begins to request positive effective power. This counteracts the rise in DC link voltage.*
DC voltage high: Max droop Register 4247 Register 4243	With this voltage value, the maximum positive effective power is added to the power set value. This counteracts the rise in DC link voltage.*
DC link precharge voltage reserve Register 4225	With this parameter, it is possible to increase the voltage level of the precharging process for the DC link. The value refers to a DC link half. Thus, an increase of 10 V causes the voltage of the DC link to increase by 20 V. The AC-DC module is configured so that the precharge process of the DC link is performed as quickly as possible. For mains connection points with a short-circuit power ratio < 5 , it can be necessary to provide a larger voltage reserve at the DC link to ensure reliable switching of the AC-DC module to the AC grid.
*) Only plausible set values are adopted. The set values must satisfy the conditions: Minimum < Set < Maximum	
**) If 2 registers are named: 1st register applies to 400 V at 50 Hz, 2nd register applies to 480 V at 60 Hz (see "Tab. 28", pg. 91).	

Adjustable parameters for "DC link settings"

Tab. 30

Setting DC link with "mains current regulation" regulator type

1. Select >Operation >AC-DC module settings.
2. Enter the desired values in the "DC link settings" section.

Parameter**	Description
Minimum DC voltage Register 4231 Register 4234	<p>Below this lower voltage limit, the AC-DC module stabilizes the DC link voltage and prevents the DC link voltage from dropping further.*</p> <p>Note</p> <p>The value must be greater than twice the grid voltage amplitude. Otherwise, the entry is ignored.</p> <p>Example for a 400 V grid: $\sqrt{\frac{2}{3}} \times 400 V \times 2 = 654 V$</p> <p>The measured grid voltage amplitude is displayed in the same section under "Voltage threshold of DC link half".</p>
Set DC voltage Register 4230 Register 4233	<p>If further DC-DC modules are connected to the AC-DC module and if in the "active" operating state, the set value of the DC link voltage can be set here.*</p> <p>Querying the operating state of the DC-DC modules:</p> <ul style="list-style-type: none"> ▪ Select >Operation >DC-DC module settings. ▪ In the "Module selection" section under "Select slave module", select "All modules". ▪ Read the current status in the "Slave module status" section under "Status DC module".
Maximum DC voltage Register 4232 Register 4235	<p>Above this upper voltage limit, the AC-DC module stabilizes the DC link voltage and prevents the DC link voltage from rising further.*</p>
DC link precharge voltage reserve Register 4225	<p>With this parameter, it is possible to increase the voltage level of the precharging process for the DC link.</p> <p>The value refers to a DC link half. Thus, an increase of 10 V causes the voltage of the DC link to increase by 20 V.</p> <p>The AC-DC module is configured so that the precharge process of the DC link is performed as quickly as possible. For mains connection points with a short-circuit power ratio < 5, it can be necessary to provide a larger voltage reserve at the DC link to ensure reliable switching of the AC-DC module to the AC grid.</p>
<p>*) Only plausible set values are adopted. The set values must satisfy the conditions: Minimum < Set < Maximum</p> <p>**) If 2 registers are named: 1st register applies to 400 V at 50 Hz, 2nd register applies to 480 V at 60 Hz (see "Tab. 28", pg. 91).</p>	

Adjustable parameters for "DC link settings"

Tab. 31

The adopted and, thus, active values are displayed below the input fields.

7.11 Operation with voltage regulation (grid-forming or grid-following mode)

Function description "Operation with voltage regulation"

The voltage regulator of the TruConvert AC 3025 can replicate the behavior of a synchronous machine. Thus, its operating performance can be compared to that of a rotating machine, e.g., a diesel generator or steam turbine.

The system¹³ can be operated parallel to the grid or to support a stand-alone network¹⁴. Moreover, the system is able to establish a stand-alone network on its own (black start capable).

The internal droop allows multiple AC-DC modules to be connected in parallel without the individual AC-DC modules needing to communicate with one another. Furthermore, a virtual impedance realized in the AC-DC module ensures the necessary attenuation of dynamic processes for the parallel connection.

In the case of operation with voltage regulation, 2 different regulation modes can be selected:

- "grid-forming"
In grid-forming mode, the internal droop uses static linearization points for frequency and voltage, which have been specified by the operator. The internal droop thus forms a rigid voltage system.
In this mode, the inverter can be used as:
 - Stand-alone device.
 - Grid-forming device within a stand-alone network that consists of multiple devices.
 - Grid-forming device within a public grid.
- "grid-following"
In grid-following mode, the internal droop adjusts the linearization points for frequency and voltage to the variables that exist in the grid. In the adjusted state, the influence of the droop is therefore suppressed. The behavior of the inverter remains stationary, similar to operation with mains current regulation.
In this mode, the inverter must be connected to a public grid or a stand-alone network.

13 A system can consist of: 1 AC-DC module, multiple AC-DC modules connected in parallel or 1 AC-DC module with connected DC-DC modules.

14 Restrictions are to be observed.

Frequency - effective power characteristic curve

For grid-forming operation of a single device, the stand-alone network frequency is determined as a function of:

- Device nominal values f_N and P_N
- Parameters f_{lin} and DroopKP
- Effective power set value P_{set}
- Effective power P_{act} consumed by load

The device typically has, e.g., a frequency deviation of -2% at the rated effective power output.

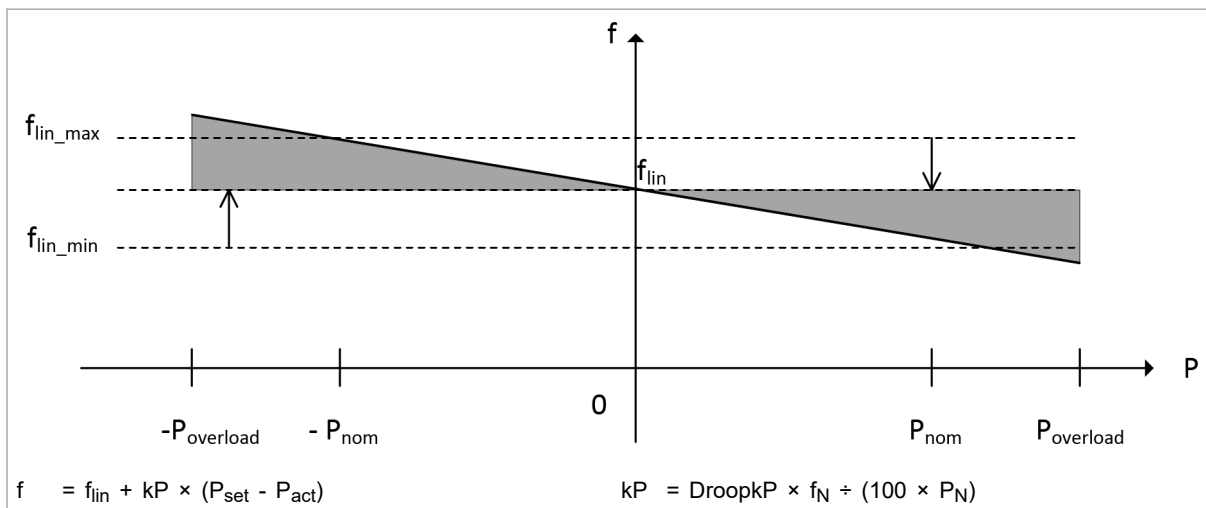

Frequency - effective power characteristic curve, shown as an example

Fig. 54

Example:

$$f_{lin} = 50 \text{ Hz}, f_N = 50 \text{ Hz}, P_{set} = 0 \text{ W}, P_{act} = P_N = 25 \text{ kW}$$

$$\text{DroopKP} = 2 \% = 0.02$$

$$\begin{aligned} f &= 50 \text{ Hz} + 0.02 \times 50 \text{ Hz}/25000 \text{ W} \times (0 \text{ W} - 25000 \text{ W}) \\ &= 50 \text{ Hz} + 40\text{E-}6 \text{ Hz/W} \times (-25000 \text{ W}) \\ &= 49 \text{ Hz} \end{aligned}$$

Voltage - reactive power characteristic curve

For grid-forming operation of a single device, the stand-alone network voltage is determined as a function of:

- Device nominal values U_N and Q_N
- Parameters U_{lin} and DroopKQ
- Reactive power set value Q_{set}
- Reactive power Q_{act} drawn by the load

The device typically has, e.g., a voltage deviation of -5% at the rated reactive power output (inductive loads).

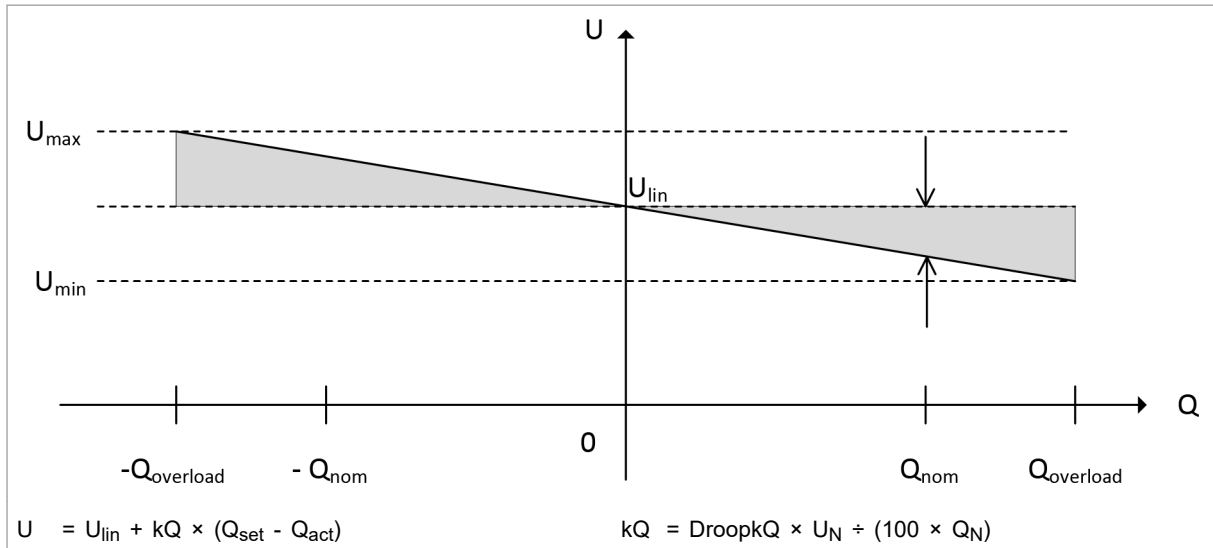

Voltage - reactive power characteristic curve, shown as an example

Fig. 55

Example:

$U_{lin} = 231 \text{ V}, U_N = 231 \text{ V}, Q_{set} = 0 \text{ VAR}, Q_{act} = Q_N = 25 \text{ kVAR}$

$DroopkQ = 5 \% = 0.05$

$U = 231 \text{ V} + 0.05 \times 231 \text{ V}/25000 \text{ VAR} \times (0 \text{ VAR} - 25000 \text{ VAR})$

$= 231 \text{ V} + 462E-6 \text{ V/VAR} \times (-25000 \text{ VAR})$

$= 219.45 \text{ V}$

Supported loads

As the inverter is a full-fledged 4-quadrant device, in grid-forming mode it can support any loads and power factors on all 3 phases.

Load type	Power [kVA]
Resistive	100 %
Capacitive	70%
Inductive	70%
Non-linear	50% (max. crest factor = 3%)

Load types supported in grid-forming mode in relation to device nominal power

Tab. 32

The following must be observed in grid-forming mode:

- Continuous operation possible at: $\leq 25 \text{ kW}$
- 125% of the rated effective power for 10 min*
- 150% of the rated effective power for 1 min*
- *) The power can only be maintained for this length of time; afterward, the device switches off.

Setting operation with voltage regulation

Condition

- No power is transferred: The device is in "Idle" mode.

⚠ DANGER

Life threatening voltage!

If the device is connected to the public grid in voltage regulation mode ("Controller and grid type selection" = "voltage control"), this can lead to a forbidden island situation because the safety function to prevent islanding is not active.

- Make sure that the local technical connection requirements (grid codes) allow connection in voltage regulation mode.
- Or obtain the express permission of the responsible grid operator.
- If no permission has been given, do **not** connect the device to the public grid.

Selecting regulator and grid type

1. Setting the regulation system:
 - Select *>Operation >AC-DC module settings*.
 - In the "General AC settings" section under "Controller and grid type selection", select "voltage control".
2. Under "Voltage source mode", select a regulation mode:
 - "grid-forming": grid-forming mode.
 - "grid-following": grid-following mode.
3. To set the parameters for this operating mode, (see "[Parameterization "Operation with voltage regulation"](#)", pg. 111).

Performing a black start (only with grid-forming mode)

A black start is possible in grid-forming mode only ("grid-forming").

With a black start, the AC voltage is built up by one or more AC-DC modules from 0 V.

All AC-DC modules that are connected together on one system control must be in the same AC grid.

Depending on the composition of the system (1 or n AC-DC modules and 0 or m connected DC-DC modules), the appropriate precharging mechanism must be selected for the internal DC link voltage.

If the precharging of the DC link is concluded using one of the scenarios mentioned in the following, the AC-DC module closes its mains contactor and begins to establish the off-grid voltage. To avoid excessive switch-on currents, the voltage is increased to the desired value within approximately one half grid period. Multiple AC-DC modules connected in parallel build up the AC voltage simultaneously and share the current of the load if they are activated simultaneously.

4. If the system includes TruConvert DC modules as sub-slaves: activate internal precharging circuit with DC-DC modules.
 - Select *>Operation >Device control AC-DC mode*.
 - In the "Device control settings AC-DC" section under "DC link precharge config", select: "internal with DC module".

The device then uses its internal precharging circuit to bring the DC link voltage to the required level and then automatically starts the DC-DC modules. The AC voltage is now built up.

5. If the system includes independent TruConvert DC modules (separate system controls for AC-DC modules and DC-DC modules):
 - Select *>Operation >Device control AC-DC mode*.
 - In the "Device control settings AC-DC" section under "DC link precharge config", select: "internal & wait".
 - The AC module precharges the DC link to the required startup voltage of the DC-DC modules but without building up the off-grid voltage.

As soon as the startup voltage of the DC-DC modules is reached in the DC link, the battery management system (BMS) can activate the power stage of the DC-DC modules.
 - Once the DC-DC modules are in operation and the DC link voltage is stable: Select "internal" under "DC link precharge config".

The off-grid voltage is now built up.

6. If the DC link voltage is provided by an external supply (e.g., high-voltage battery):
 - In the "Device control settings AC-DC" section under "DC link precharge config", select: "external".
 - The BMS must ensure that the DC link voltage is stable before the power release of the AC-DC module is requested.

Starting with available network

7. Select appropriate precharging mechanism for the internal DC link voltage:
 - If the system includes independent TruConvert DC modules (separate system controls for AC-DC modules and DC-DC modules): See step 4.
 - If the DC link voltage is provided by an external supply (e.g., high-voltage battery): See step 6.

The device first synchronizes with the present grid voltage before the mains contactor is closed.

Switching on power transfer

8. To switch on power transfer and specify the set values: proceed in the same way as for operation with mains current

regulation (see "Switching the transmission of power on/off", pg. 91).

The following applies in the case of grid-following mode: Only if the real values for grid frequency and grid voltage correspond to the preselected linearization points do the actual values P_{act} and Q_{act} assume the set values P_{set} and Q_{set} after the start-up time.

Parameterization "Operation with voltage regulation"

The inverter has an internal droop that makes its operating performance comparable to that of a rotating machine.

In the stationary state in grid-forming mode, the functional relationships that are described by the frequency-effective power characteristic curve (see "Fig. 54", pg. 107) and the voltage-reactive power characteristic curve (see "Fig. 55", pg. 108) apply.

Unlike in grid-forming mode, in grid-following mode the effect of the droop is suppressed in the stationary state and the inverter behaves in a similar way to operation with mains current regulation. This is why the characteristic curves do not apply to grid-following mode.

Both characteristic curves can be set individually using appropriate parameters. The parameters each influence the slope and the offset of the characteristic curves.

To avoid undesirably large deviations of the linearization points from the nominal frequency and voltage values, minimum and maximum limits of the linearization points can also be configured.

All adjustable parameters are listed in the following table.

Parameter	Description	Unit	Adjustment range		Factory settings	Step size
			Minimum	Maximum		
DroopkP (referred to as "Frequency slope" in the web GUI)	Parameter influences the slope "Frequency slope" (kP) of the characteristic curve.	% of f_N/P_N	0.1	4	2	0.01
Frequency lin. point offset	Linearization point	Hz	-5	5	0	0.01
Maximum neg. flin delta f	Maximum negative frequency difference of the lin. point (to f_N)	Hz	-6	6	-2.5	0.01
Maximum pos. flin delta f	Maximum positive frequency difference of the lin. point (to f_N)	Hz	-6	6	2.5	0.01

Parameter	Description	Unit	Adjustment range		Factory settings	Step size
			Minimum	Maximum		
DroopkQ (referred to as "Voltage slope" in the web GUI)	Parameter influences the slope "Voltage slope" (kP) of the characteristic curve.	% of V_N/Q_N	0.1	10	5	0.01
Voltage adjustment factor	Voltage factor, specifies the linearization point.	% of V_{nom}	75	120	100	1
Minimum voltage factor	Minimum voltage as a percentage	% of V_{nom}	75	120	85	1
Maximum voltage factor	Maximum voltage as a percentage	% of V_{nom}	75	120	115	1

Abbreviations:
 $V_{nom} = V_N =$ Nominal voltage / $P_{nom} = P_N =$ Nominal effective power / $Q_{nom} = Q_N =$ Nominal reactive power / $f_{nom} = f_N =$ Nominal frequency

Adjustable parameters for frequency - effective power characteristic curve and voltage - reactive power characteristic curve

Tab. 33

All parameters can also be set by means of Modbus (see "Tab. 28", pg. 91).

Parameter	Description
DroopkP (referred to as "Frequency slope" in the web GUI)	Used to calculate the slope Frequency slope (kP). Calculation of the slope: $kP = \text{DroopkP} \times f_N / (100 \times P_N)$ Example: DroopkP = 2 Slope kP = 40 $\mu\text{Hz/W}$ or 40mHz/kW for a 25 kW device on a 50 Hz grid Parameters cannot be changed during running operation.
Frequency lin. point offset	Frequency linearization point offset: Specifies the linearization point. Calculation: $f_{lin} = f_N + \text{frequency offset}$ Example: Frequency offset = 0.5 Linearization point = 50.5 Hz on a 50 Hz grid Working frequency = Linearization point if $P_{set} = P_{act}$

Parameter	Description
Maximum neg. flin delta f Maximum pos. flin delta f	<p>The individual specification of the parameters for slope and linearization point of the droop characteristic curve can, under certain operating conditions, lead to relatively large deviations of the nominal frequency of the stand-alone network. For this reason, it is possible to define the minimum and maximum limit of the linearization point. Settings of "Frequency lin. point offset" outside of these limits are ignored; the corresponding limit value is used.</p> <p>The limit values refer to the linearization point and limit only this point. The operating value for the frequency can go beyond the limit values depending on the target/actual value difference of the power.</p> <p>Example: With Frequency slope = 4 and Frequency lin. point offset = -1 Hz</p> <p>The effective power is specified with: $P_{set} = -P_N$ ($S_{set} = S_N$, $\cos(\varphi) = -1$) and the effective power actual value is $P_{act} = +P_N$.</p> <p>This means that a frequency of 45 Hz is set on the 50 Hz stand-alone network. $f = f_N + \text{Freq-Offs} + (\text{DroopkP}/100 \times f_N)/P_N \times (P_{set} - P_{act}) = 49 \text{ Hz} + (2 \text{ Hz})/P_N \times (-P_N - P_N) = 45 \text{ Hz}$.</p> <p>Parameters cannot be changed during running operation.</p>
DroopkQ (referred to as "Voltage slope" in the web GUI)	<p>Used to calculate the slope Voltage slope (kQ).</p> <p>Calculation of the slope: $kQ = \text{DroopkQ} \times U_N / (100 \times Q_N)$</p> <p>Example: DroopkQ = 5</p> <p>Slope kQ = 462 $\mu\text{V}/\text{VAr}$ or 462 mV/kVAr for a 25 kVAr device on the grid with 230 V phase voltage</p> <p>Parameters cannot be changed during running operation.</p>
Voltage adjustment factor	<p>Voltage adjustment factor: Specifies the linearization point.</p> <p>Calculation: $U_{lin} = \text{voltage factor} \times U_N$</p> <p>Example: Voltage factor = 1.05</p> <p>Linearization point = 242.5 V on grid with 230 V phase voltage</p> <p>Mains voltage = Linearization point if $Q_{set} = Q_{act}$</p> <p>Adoption of the specified linearization point is indicated in the "Active voltage adjustment factor" field.</p> <p>Restriction:</p> <ul style="list-style-type: none"> ▪ "Voltage adjustment factor" < "Minimum voltage factor": Value is adopted, but the limit value "Minimum voltage factor" still remains effective. (See parameter description "Minimum voltage factor") ▪ "Voltage adjustment factor" > "Max possible voltage adjustment factor": Value is not adopted. (See parameter description "Maximum voltage factor")

Parameter	Description
Minimum voltage factor	<p>The individual specification of the parameters for slope and linearization point of the droop characteristic curve can, under certain operating conditions, lead to relatively large deviations of the nominal voltage of the stand-alone network. This is why a limit value can be defined for the linearization point.</p> <p>The minimum possible value of the linearization point is determined by:</p> <ul style="list-style-type: none"> ▪ Adjustable limiting under "Minimum voltage factor". ▪ Currently available DC link voltage. <p>If the value under "Voltage adjustment factor" is lower than the value under "Minimum voltage factor", this "Voltage adjustment factor" is adopted in the "Active voltage adjustment factor" field. The limit value "Minimum voltage factor" still remains effective.</p> <p>The limit value refers to the linearization point and limits only this point. The operating value for the voltage can go beyond the limit value depending on the target/actual value difference of the power.</p>
Maximum voltage factor	<p>The individual specification of the parameters for slope and linearization point of the droop characteristic curve can, under certain operating conditions, lead to relatively large deviations of the nominal voltage of the stand-alone network. This is why a limit value can be defined for the linearization point.</p> <p>The maximum possible value of the linearization point is determined by:</p> <ul style="list-style-type: none"> ▪ Adjustable limiting under "Maximum voltage factor". ▪ Currently available DC link voltage. <p>The value is shown in the "Max possible voltage adjustment factor" field.</p> <p>The limit value refers to the linearization point and limits only this point. The operating value for the voltage can go beyond the limit value depending on the target/actual value difference of the power.</p> <p>Parameters cannot be changed during running operation.</p>

Description of the parameters

Tab. 34

Entering parameters for "Operation with voltage regulation"

1. Select *>Operation >AC-DC module settings*. Enter the desired values in the "AC voltage control settings" section.
2. Or: Set parameters via Modbus registers (see "Tab. 28", pg. 91).

Further information on "Operation with voltage regulation"

Virtual impedance Due to the nature of the system, rotating machines, such as synchronous generators, have reactances on account of their winding impedances. In dynamic processes, these reactances have an attenuating effect and typically limit short-circuit currents to approximately 10 times the nominal current.

The device has an integrated virtual impedance that provides appropriate attenuation and supports the parallel connection of multiple systems, especially during dynamic operating processes.

Short circuit behavior

In voltage-regulated mode, the inverter has the characteristics of a voltage source. The phase currents are determined by the connected loads or feeding sources. If these lead to overcurrents, the voltage regulation is replaced by a current limiting regulator. The current limiting regulator limits the absolute value of the current to a maximum value of approx. 125 A.

Overcurrents are caused e.g. by overloads, high crest factors or short circuits.

A short circuit with low impedance gives rise to an almost square-wave alternating current with an amplitude of approx. 125 A. The short-circuit management of the inverter maintains this short-circuit current for approx. 500 ms before the device shuts down with a corresponding error message. By using appropriate fuses, this enables selectivity for grid protection.

If the current limit is only partially exceeded within a given period, the time until shutdown increases accordingly. If the current limit is exceeded during less than 10 % of the period duration, no shutdown occurs.

Note

Each intervention by the current limiting regulator immediately causes a deviation of the voltage from its sine-wave shape. At this point in time, the voltage drops to such an extent that the current does not increase above its limit value.

All connected loads or feeding sources are subject to this voltage distortion, resulting in impairment of their normal operation.

Grid-forming mode: Multiple devices in a group

If multiple devices in a group operate a stand-alone network, the total load of the stand-alone network is automatically divided over the individual devices.

Furthermore, there are various possibilities to, on the one hand, adjust the frequency and voltage of the stand-alone network and, on the other hand, individually distribute the effective powers and reactive powers over the individual devices.

By preselecting the two parameters "frequency offset" and "voltage factor", the linearization points f_{lin} and U_{lin} of the curves can be influenced (see "Fig. 54", pg. 107) (see "Fig. 55", pg. 108). This results in a parallel shift of the straight lines.

With:

- $f_{lin} = f_N + \text{frequency offset}$
- $U_{lin} = \text{voltage factor} \times U_N$

In addition, the slope kP and kQ of the straight lines can be changed by specifying the two parameters "DroopKP" and "DroopKQ".

With:

- $kP = \text{DroopkP} \times f_N / (100 \times P_N)$
- $kQ = \text{DroopkQ} \times U_N / (100 \times Q_N)$

To influence the distribution of the effective and reactive powers on the individual devices in a targeted manner, the set values for apparent power, power factor $\cos\varphi$ and the phase shift can be appropriately selected.

**Grid-forming mode:
Resulting frequency and
voltage**

If a number of n devices in a group are operating in a stand-alone network, the resulting frequency and voltage of the stand-alone network are determined as a function of the mentioned settings on the individual devices (index i) and on the total power P_{act_system} and Q_{act_system} drawn by the stand-alone network, using:

$$f = \frac{-P_{act_system} + \left(\sum_{i=1}^n P_{set,i} \right) + \left(\sum_{i=1}^n \frac{f_{lin,i}}{kP_i} \right)}{\sum_{i=1}^n \frac{1}{kP_i}}$$

Fig. 56

$$U = \frac{-Q_{act_system} + \left(\sum_{i=1}^n Q_{set,i} \right) + \left(\sum_{i=1}^n \frac{U_{lin,i}}{kQ_i} \right)}{\sum_{i=1}^n \frac{1}{kQ_i}}$$

Fig. 57

For the case that all n devices are given identical parameters for frequency offset, voltage factor, DroopKP and DroopKQ, the resulting frequency and voltage of the stand-alone network are simplified to:

$$f = \frac{\left(\sum_{i=1}^n P_{set,i} \right) kP + f_{lin} n - P_{act_system} kP}{n}$$

Fig. 58

$$U = \frac{\left(\sum_{i=1}^n Q_{set_i} \right) kQ + U_{lin} n - Q_{act_system} kQ}{n}$$

Fig. 59

The output effective and reactive power of the individual device (index k) is determined as a function of its specified set value using:

$$P_{act_k} = \frac{n P_{set_k} - \left(\sum_{i=1}^n P_{set_i} \right) + P_{act_system}}{n}$$

Fig. 60

$$Q_{act_k} = \frac{n Q_{set_k} - \left(\sum_{i=1}^n Q_{set_i} \right) + Q_{act_system}}{n}$$

Fig. 61

The given relationships apply provided the settings of the linearization points f_{lin} and U_{lin} are within the limits defined by the limiting parameters (see "Parameterization "Operation with voltage regulation"", pg. 111).

7.12 Operation with series-connected batteries

Function description "Operation with series-connected batteries"

2 batteries can be connected in series to the DC link: battery 1 to the positive DC link half and battery 2 to the negative DC link half. In this arrangement, the power flow in the two batteries can be set independently of each other.

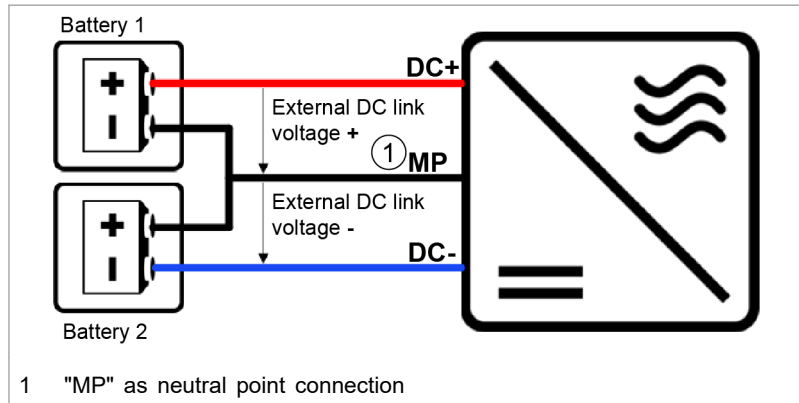

Connection principle for operation with series-connected batteries Fig. 62

The total power is determined by the usual mains power specification. How the total power is split between the 2 batteries can be set at the "balancer stage" by entering the differential voltage.

The inverter regulates the desired charging capacity (discharge capacity) bidirectionally on the grid side. This power is fed to (drawn from) the DC link, whereby the voltage of the DC link rises (falls) slightly. In the connected batteries, this rise (fall) in DC link voltage leads to consumption (output) of a current, i.e. the charging current (discharge current). The "balancer stage" can now transport power from the positive to the negative DC link half and vice versa. The "balancer stage" can shift the DC link half voltages relative to each other and split the power flow accordingly between the two DC link halves.

Setting "Operation with series-connected batteries"

- Via user interface**
1. Select *>Operation >AC-DC module settings*. Enter the desired values in the "Stacked HV battery settings" section.

Parameter description: (see "Parameterization "Operation with series-connected batteries"", pg. 119).

- Via the Modbus**
2. To set the parameters for this function:
 - In the registers, enter the desired values.

Parameter description: (see "Parameterization "Operation with series-connected batteries"", pg. 119).

Parameterization "Operation with series-connected batteries"

All adjustable parameters are listed in the following table.

Parameter	Description	Unit	Adjustment range		Factory settings	Step size
			Minimum	Maximum		
Set value ΔV (pos-neg DC link half) Register 4224		V	-150.00	150.00	0.00	0.01
Balancing mode selection Register 4252		–	on /automatic / off		automatic	–
Gain for balancing via grid Register 4253		–	0.00	1.00	1.00	0.01

Adjustable parameters for balancer stage

Tab. 35

Parameter	Description
Set value ΔV (pos-neg DC link half)	<p>Set value for the voltage difference between the positive and negative half of the DC link voltage.</p> <p>This set value is set to the current actual value of the existing voltage difference (External DC link voltages = current battery voltages) usually before power release so that the "balancer stage" initially does not shift power from one DC link half to the other after power release has occurred.</p> <p>Example: "External DC link voltage +" of 380 V and "External DC link voltage -" of 400 V yield a ΔV of: Set value $\Delta V = 380 \text{ V} - 400 \text{ V} = -20.00 \text{ V}$.</p> <p>Based on this start value, the set value for the differential voltage can then gradually be changed in the desired direction e.g. in order to balance the batteries (in the example above: from -20.00 V toward 0.00 V). The nominal value is usually predetermined by a higher-level battery charge regulation system.</p>
Balancing mode selection	<p>Various modes can be selected for the balancer stage:</p> <ul style="list-style-type: none"> ▪ "off": Switched off. ▪ "automatic": The balancer stage intervenes actively as soon as the deviation between the set value and actual value is approx. 10 V. ▪ "on": Permanently switched on. <p>The balancer stage is always operating, even if the set value and actual value are the same.</p> <p>Tip</p> <p>If symmetrical battery voltages exist, the balancer stage can be switched off in order to increase efficiency.</p>
Gain for balancing via grid	<p>In addition to the balancer stage, the inverter has another function for balancing the DC link halves. In this case, the phase currents are influenced by DC offsets. The extent to which the phase currents are influenced can be set using the "Gain for balancing via grid" factor.</p> <ul style="list-style-type: none"> ▪ "0.00": Switched off, no influence whatsoever. ▪ "1.00": Maximum influence. <p>In some applications, this function may be unwanted, e.g. in the case of operation with series-connected batteries or in grid-forming mode. This is why the function can be completely switched off (0.00) or set individually (0.01 to 1.00).</p>

Description of the parameters

Tab. 36

7.13 Data backup



Saving parameters and resetting to factory settings

All general settings that were made under *>Operation >AC-DC module settings* and *>DC-DC module settings* with "Select slave module" = "All modules" can be stored in the device and are retained following a restart as well as after switching the device off and back on again.

The general settings can be exported as a json file and then imported into another device.

Individually generated settings for single modules ("Select slave module" = "Module 1" to "Module n") cannot be stored.

Conditions

- Operation via web GUI
 - Settings to be saved are entered under *>Operation >AC-DC module settings* for "Select slave module" = "All modules" and "Select subslave module" = "All modules".
1. Select *>Operation >Save & restore settings*.
 2. In the "Save & restore settings" area under "Customer settings", select "Save" to save the current settings in the TruConvert System Control.
 3. In the "Save & restore settings" area under "Customer settings", select "Restore" to restore the factory settings.
 4. To save the current settings as a file on a hard drive of the PC:
 - In the "Import & export parameters" area under "Export parameters", press "Download".
 - In the browser window that opens, select "Save as".
 5. In the "Import & export parameters" area, press  to search for and select a file on a hard drive of the PC.
 6. To load the selected file to the system control:
 - Press the  button to upload the file.
 - To permanently save the settings in the TruConvert System Control: In the "Save & restore settings" area under "Customer settings", select "Save".

7.14 System configuration

If the combination of devices connected to the system control is changed, the new system configuration must then be entered via the web-based user interface.

Setting the system configuration

Conditions

- Operation via web GUI
- Devices (AC-DC module, DC-DC modules) are connected to the system control

Switching on devices

1. To switch on the system control and the modules: switch on the 24 V supply voltage.

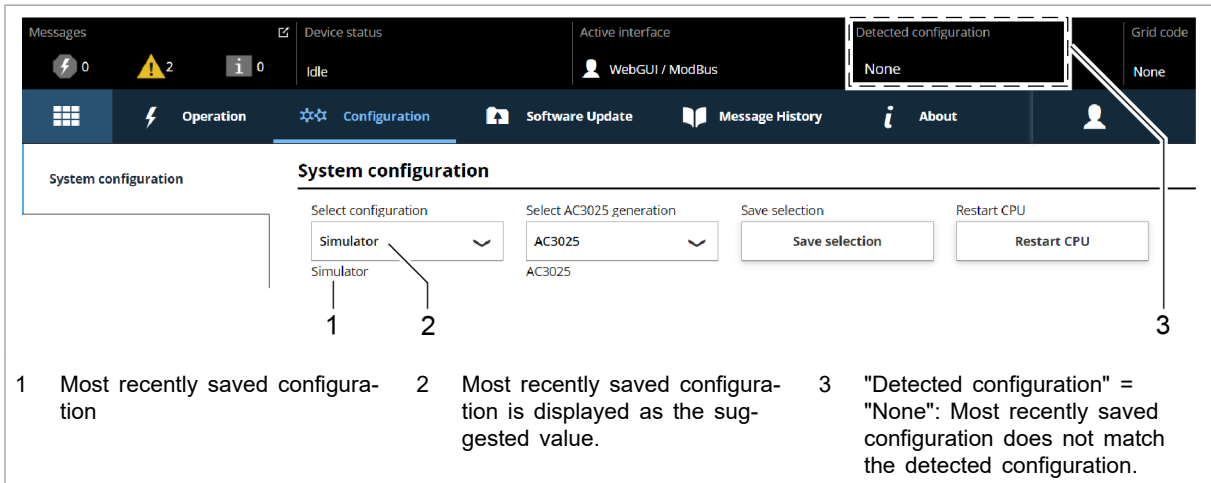

Input screen "System configuration"

Fig. 63

The input screen "System configuration" is displayed.

The connected devices do not match the expected configuration, i.e. the most recently saved configuration.

Status LEDs on the system control: All 3 LEDs blink synchronously.

Status LEDs on the AC-DC module: The green and red LEDs light up and the yellow LED flashes.

Setting the system configuration

2. Select >Configuration >System configuration.

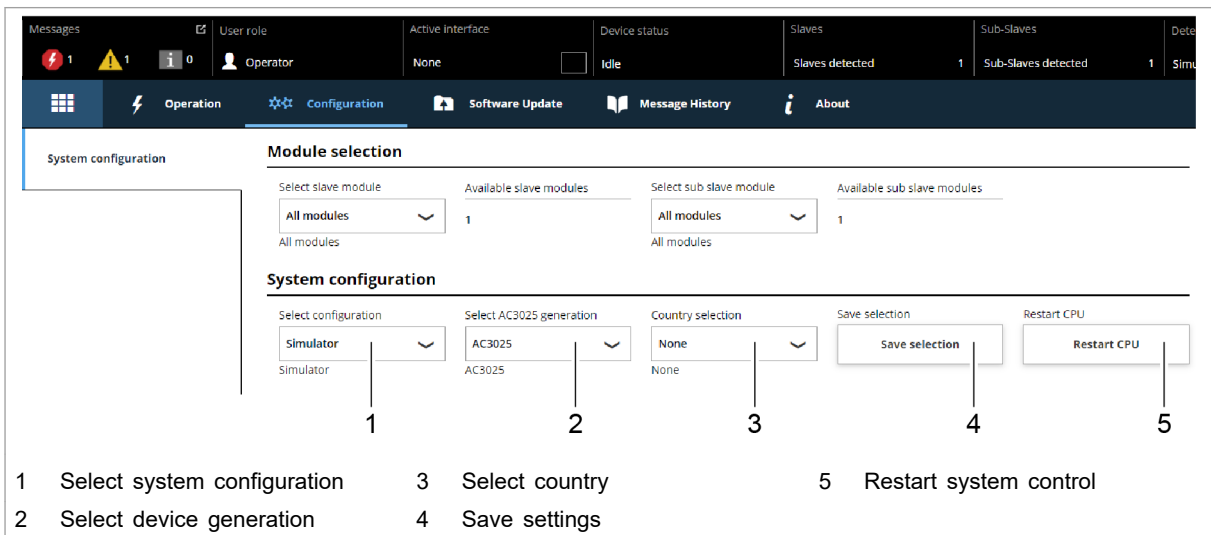

Screen: Set system configuration

Fig. 64

3. In the "Module selection" section under "Select slave module", select: "All modules".
4. In the "System configuration" section under "Select configuration", select the existing system configuration:

- No configuration
This configuration only occurs in the event of an error, e.g., if there is no connection to the modules (check cables) or if an incorrect module type was detected (check alarm messages).
 - Simulator
The system control alone is used and connected modules are simulated.
 - DC-DC configuration
Only DC-DC modules are connected to the system control.
 - $n*(AC-DC + m*DC-DC)$
AC/DC and DC/DC modules are connected to the system control.
5. Under "Select AC3025 generation", select the device generation: "AC3025".
 6. Under "Country selection", select the location of the device.
If the factory setting "None" is retained, it will not be possible to switch on the device later.
 7. To save the selection: press "Save selection".
 8. To restart the TruConvert System Control: press "Restart CPU".

The system control balances the set system configuration with the actually connected modules. If both values match, the set system configuration is displayed in the status bar under "Detected Configuration".

If the set system configuration differs from the automatically detected system configuration, "None" is displayed in the status bar under "Detected Configuration". In addition, a message is output. Press  in the sidebar to display the messages.

Status LEDs on the AC-DC module and system control: The LEDs remain off immediately after the restart. The green LED begins to flash after a few seconds.

The system is ready for operation: It is in the "Idle" operating state and the start screen is displayed.

7.15 Setting grid codes

Grid codes define rules that generation systems must obey for authorization to connect to the public grid. In particular, these rules regulate behavior in the event of grid fluctuations.

The grid operator determines the behavior of systems in the event of undervoltage, overvoltage and frequency deviation, and also defines the connect and disconnect conditions.

Conditions

- Initial commissioning was performed (see "Commissioning", pg. 63).
- Password for grid codes is available. (Request from TRUMPF Service.)
- AC-DC module is idling: In the status bar under "Device status" = "Idle".

NOTICE

External grid and system protection required!

- Install external grid and system protection.
- The grid and system protection must meet the country-specific requirements for grid and system protection.

NOTICE

To connect and operate the TruConvert AC 3025 in parallel operation with the public low-voltage grid, the following points are to be adhered to:

- The applicable legal and official regulations.
- Country-specific grid codes (TAB: technical connection requirements) of the mains operator.
- The configuration of the grid codes is to be agreed upon, implemented and documented together with the grid operator prior to connection.
- During operation, the conditions (grid codes, TAB) on which the decisions regarding the connection of the generating system and/or of the accumulator were based may **only** be changed with the consent of the grid operator.

Selecting grid code

1. Select *>Configuration >System configuration*.
2. In the "Grid code configuration" area under "Password", enter the password for editing the grid codes.

Additional input fields are displayed.

3. In the "Grid code configuration" area under "Select grid code", select the desired grid code.

The selected grid code must correspond to the previously selected AC grid.

The selected grid code is displayed as an additional sub-menu item in the submenu.

4. Select *>Configuration >"Grid code xxx"*.
5. Set the parameters for the selected grid code.

The individual functions are described separately (see supplement to the "TruConvert System Control, Grid Codes" operating instructions).

Adopting grid code settings in system

Note

After entering the password, there is a time window of 15 min in which the parameters can be set and permanently stored.

If the parameters are not stored until after the window has elapsed, they are only applied for the current operation. After a 24 V reset, restart of the CPU or a software update, the settings are lost.

6. To save the changes:
 - Select *>Configuration >System configuration*.
 - In the "Grid code configuration" area, click on "Save grid code settings".

7.16 System settings

Setting the system time

User interface

As soon as the device is connected to the PC, the local time of the PC is converted to UTC and adopted in the system control as system time.

In addition, adoption of the system time can also be triggered manually.

1. In the sidebar, click on "Settings" .

The sidebar is displayed.

2. To adopt the system time from the PC for the device, press "Synchronize to local computer".

The system time of the PC is displayed on the user interface ("Show advanced settings") and transferred to the device.
3. To make your own settings: Press "Show advanced settings" in the "Time and date" area.
 - Under "Time zone", select the desired time shift relative to UTC.
 - Use the "Time format" slide switch to select between 24-hour display and 12-hour display.
 - Under "Time" and "Date", enter the desired time and the date.
 - Then press "Submit time and date".

Changing network settings

Note

Network settings can only be changed via the web GUI.

Changing the IP address

1. In the sidebar, click on "Settings" .
2. In the "Network" area under "IP address", enter new values.
IP address of the device on delivery:
 - 192.168.1.2
3. Note the new IP address so as to be able to access the device via the user interface.
4. Press "Submit network settings".
The network settings are transferred to the device.
5. To restart the system control: press "Reboot".

Using the Reset button to reset the IP address

If the IP address of the device was changed and is not known, the IP address can be reset to the factory settings with the help of the Reset button.

Notice: This function can also be used to reset all customer parameters to the factory settings.

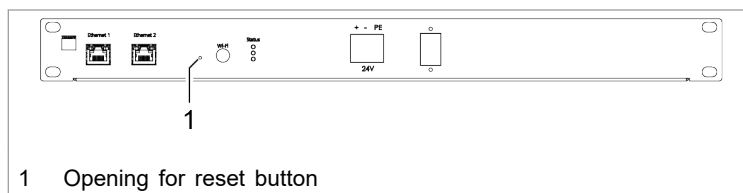

Reset button on the system control

Fig. 65

6. Insert a small pen tip or piece of wire into the opening for the Reset button and press the Reset button.
 - Press for 3-5 seconds: IP address is reset to the factory settings.
 - Press and hold for 10 seconds: all device parameters are reset to factory settings.

After the reset, the operating panel automatically performs a restart.

Changing network settings (IP subnet and gateway)

7. In the sidebar, click on "Settings" .
8. In the "Network" area, enter new values.

Input field	Value	Description
"Host address"	Text field	The device can be given an individual name. This name instead of the IP address can be entered in the web browser in order to access the device.
"DHCP client"	OFF	The device receives a fixed IP address. The IP address is entered in the "IP address" input field.
	ON	The DHCP client is enabled and receives an IP address from the customer DHCP server.
"IP address"	192.168.1.3 (example)	The IP address is used to integrate the device in a network. The IP address can be entered in the web browser in order to access the device.
"Subnet mask"	255.255.255.128 (example)	Set the same subnet mask as that on the higher-level system control.

Input fields for network settings

Tab. 37

9. Press "Submit network settings".

The network settings are transferred to the device.



10. To restart the system control: press "Reboot".

7.17 Software update

Perform software update

Conditions

- Operation via web GUI
- Zip file with new software stored on PC.

1. Select *>Software Update* .
2. In the "Software update" area, press the  button and open the zip file.
3. Press the  button to upload the zip file.

If the update was performed successfully, the system control automatically performs a restart.

Tip

To ensure that the new software is adopted error-free, perform a manual restart of the generator.

7.18 Device information

Displaying device information

System control

1. Select *>About*.
2. In the "Software package" section, read the details on the installed software package.
Relevant details are: "Integration level" and "Buildnumber".
3. In the "System control" section, read off the individual items of information for the system control:
 - Under "Software version application" and "Software version bootloader": the software versions on the system control (part of the "Software package").
 - Under "Serial number": the serial number of the system control.

Reading off software version and serial number of AC-DC modules

4. In the "Module selection" section, read off the number of available AC-DC modules under "Available slave modules".
The AC-DC module, which is directly connected to the system control with the data cable, is "Module 1". The next AC-DC module, which is connected to data output "OUT" of "Module 1", is "Module 2", etc.
5. Under "Select slave module", select the desired AC-DC module.
6. In the "AC-DC module" section under "Software version application" and "Software version bootloader", read off the software versions on the AC-DC module (part of the "Software package").
7. Under "Serial number", read off the serial number of the AC-DC module.

Reading off software version and serial number of DC-DC modules

8. In the section "Module selection" under "Select slave module", enter the AC-DC module to which the desired DC-DC module is connected.
9. In the "Module selection" section, read off the number of available DC-DC modules under "Available sub slave modules".
The DC-DC module, which is directly connected to the AC-DC module with the data cable, is "Module 1". The next DC-DC module, which is connected to data output "OUT" of "Module 1", is "Module 2", etc.
10. Under "Select sub slave module", select the desired DC-DC module.
11. In the "DC-DC module" section under "Software version application" and "Software version bootloader", read off the software versions on the DC-DC module (part of the "Software package").

12. Under "Serial number", read off the serial number of the DC-DC module.

Tip

The serial numbers of the system control and the modules can also be queried via Modbus (see "Modbus Register Map", pg. 77).

7.19 State diagram

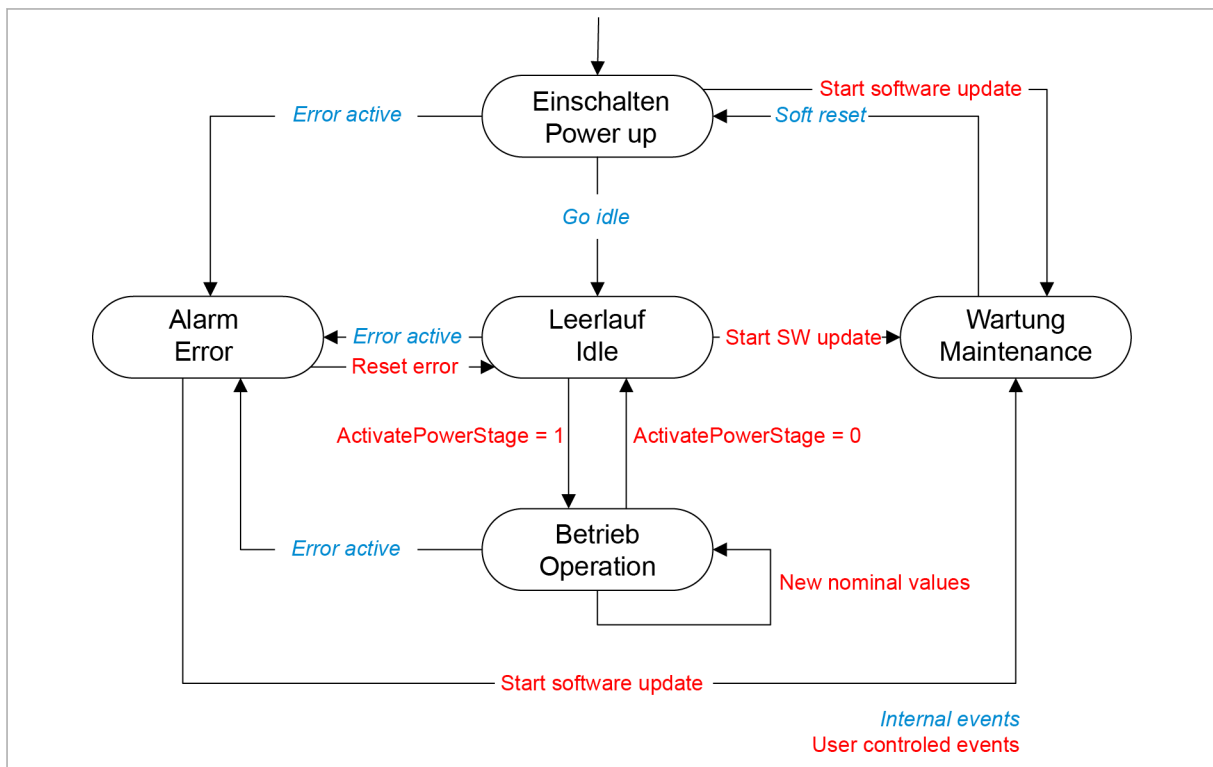

State machine

Fig. 66

8. Maintenance

Note

Housing must not be opened

The housing of the generator is sealed with stickers. Damage to the seals or opening the housing will invalidate the warranty.

8.1 Periodic check of the environmental conditions

In the event of poor environmental conditions, e.g. air with oil, dust and conductive parts, the fans may draw in particles that damage the module. The environment should therefore be kept as clean as possible.

8.2 Cleaning

If necessary, clean the module with a dry cloth.

8.3 Exchanging fans

TRUMPF recommends replacing the ventilator after an operation lifetime of 6 years.

- Only have fans exchanged by TRUMPF personnel or trained staff.

8.4 Performing software updates

Software updates can only be made via the user interface.

- Have software updates for the PCS performed by TRUMPF personnel only; if you perform the updates yourself, consult with TRUMPF personnel beforehand.

9. Troubleshooting

9.1 Fault indication and messages

Faults are displayed at different positions:

- Status LEDs on the AC-DC module.
- Status LEDs on the TruConvert System Control.
- On the web-based user interface.
- Via the Modbus.

Fault indication with the LEDs

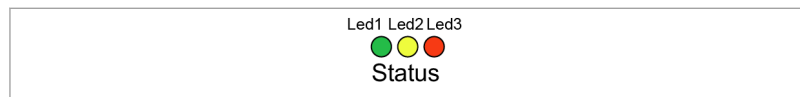

Status LEDs on TruConvert AC 3025 and TruConvert System Control

Fig. 67

LED	Errors
1 (green)	off
2 (yellow)	off
3 (red)	Flashing

Display of the status LEDs in the event of a fault

Tab. 38

9.2 Messages

A distinction is made between alarm messages and warning messages.

Alarm message Power operation is automatically shut off if serious errors occur. The PCS switches to the alarm state and outputs an alarm message. Power operation can only be restarted after the cause of the alarm has been removed and the alarm message has been reset (see "State diagram", pg. 129).

Warning message In case of less severe faults, the power operation is not interrupted, but a warning message is issued.

Display of alarm and warning messages The messages that are output always consists of an alarm or warning number and a message text.
When operating the device with the web GUI, the alarm and warning numbers are displayed together with the message text.

In case of control with Modbus, only the numbers and no text are transmitted.

Resetting alarm and warning messages

(see ["Displaying and resetting messages"](#), pg. 94)

List of alarm and warning messages

The following tables show the most important alarm and warning messages, with notes on error causes and how to correct them.

If a message reappears repeatedly after resetting and restarting the device, please contact TRUMPF Service.

If a message appears whose number is not listed in the table, please also contact TRUMPF Service.

Alarm messages

Number	Message	Effect	Cause	Action	Detected by
40300	RS-485 communication alarm.	No operation possible.	Communication problem on RS-485 bus.	Check RS-485 communication.	System control
40301	RS-485 communication alarm.	No operation possible.	Communication problem on RS-485 bus.	Check RS-485 communication.	System control
40302	Active interface (Modbus or WebGUI) communication timeout has occurred	No operation possible.	Active interface (Modbus or WebGUI) communication timeout has occurred	Check active interface (Modbus or WebGUI) or disable timeout.	System control
40303	RS-485 communication alarm.	No operation possible.	Communication problem on RS-485 bus.	Check RS-485 communication.	System control
40304	No slave module was found, please check RS-485 connection(s).	System cannot finish start-up procedure	No slave module was found.	Check RS-485 connection(s) and modules.	System control
40305	Number of or combination of connected slave types not supported.	System cannot finish start-up procedure	Number of or combination of connected slave types not supported.	Check module configuration. Only homogeneous modules are allowed on one RS-485 bus.	System control
40412	Software versions of system control and module(s) do not match.	System cannot finish start-up procedure	Software versions of system control and module(s) do not match.	Software update necessary.	System control
40413	Software versions of system control and module(s) do not match.	System cannot finish start-up procedure	Software versions of system control and module(s) do not match.	Software update necessary.	System control
40414	Software versions of system control and module(s) do not match.	System cannot finish start-up procedure	Software versions of system control and module(s) do not match.	Software update necessary.	System control
40415	Software versions of system control and module(s) do not match.	System cannot finish start-up procedure	Software versions of system control and module(s) do not match.	Software update necessary.	System control
40416	Software versions of system control and module(s) do not match.	System cannot finish start-up procedure	Software versions of system control and module(s) do not match.	Software update necessary.	System control
50000	Overtemperature IGBT bridge 1.	No operation possible.	Overtemperature IGBT bridge 1.	Check the fan and the ambient temperature.	AC-DC module
50001	Overtemperature IGBT bridge 2.	No operation possible.	Overtemperature IGBT bridge 2.	Check the fan and the ambient temperature.	AC-DC module
50002	Overtemperature IGBT bridge 3.	No operation possible.	Overtemperature IGBT bridge 3.	Check the fan and the ambient temperature.	AC-DC module

Number	Message	Effect	Cause	Action	Detected by
50003	Overtemperature balancer.	No operation possible.	Overtemperature balancer bridge.	Check the fan and the ambient temperature.	AC-DC module
50004	Ambient temperature over allowed range.	No operation possible.	Ambient temperature over allowed range.	Check the ambient temperature.	AC-DC module
50005	Overcurrent L1.	Device switches off.	Overcurrent L1.	Check cabling of L1, grid voltage sense lines, AC contactor, external components (fuses etc.)	AC-DC module
50006	Overcurrent L2.	Device switches off.	Overcurrent L2.	Check cabling of L2, grid voltage sense lines and AC contactor, external components (fuses etc.)	AC-DC module
50007	Overcurrent L3.	Device switches off.	Overcurrent L3.	Check cabling of L3, grid voltage sense lines and AC contactor, external components (fuses etc.)	AC-DC module
50008	Overcurrent balancer.	Device switches off.	Overcurrent balancer bridge.	Contact service.	AC-DC module
50009	Overvoltage grid L1.	No operation possible.	Overvoltage grid L1.	Check grid voltage L1 and external devices.	AC-DC module
50010	Overvoltage grid L2.	No operation possible.	Overvoltage grid L2.	Check grid voltage L2 and external devices.	AC-DC module
50011	Overvoltage grid L3.	No operation possible.	Overvoltage grid L3.	Check grid voltage L3 and external devices.	AC-DC module
50012	Overvoltage filter capacitor L1.	Device switches off.	Overvoltage filter capacitor L1.	Check grid voltage L1, grid voltage sense lines and AC contactor.	AC-DC module
50013	Overvoltage filter capacitor L2.	Device switches off.	Overvoltage filter capacitor L2.	Check grid voltage L2, grid voltage sense lines and AC contactor.	AC-DC module
50014	Overvoltage filter capacitor L3.	Device switches off.	Overvoltage filter capacitor L3.	Check grid voltage L3, grid voltage sense lines and AC contactor.	AC-DC module
50015	Overvoltage DC link positive part.	Device switches off.	Overvoltage DC link positive part.	Check DC link voltage and midpoint.	AC-DC module
50016	Overvoltage DC link negative part.	Device switches off.	Overvoltage DC link negative part.	Check DC link voltage and midpoint.	AC-DC module
50018	Overcurrent L1 hardware.	Device switches off.	Overcurrent L1.	Check cabling of L1, grid voltage sense lines and AC contactor.	AC-DC module

Number	Message	Effect	Cause	Action	Detected by
50019	Overcurrent L2 hardware.	Device switches off.	Overcurrent L2.	Check cabling of L2, grid voltage sense lines and AC contactor.	AC-DC module
50020	Overcurrent L3 hardware.	Device switches off.	Overcurrent L3.	Check cabling of L3, grid voltage sense lines and AC contactor.	AC-DC module
50021	Overcurrent balancer hardware.	Device switches off.	Overcurrent balancer bridge.	Contact service.	AC-DC module
50024	Overcurrent/short circuit in island L1	Device switches off.	Overcurrent/short circuit in island L1	Check loads and fuses in micro-grid.	AC-DC module
50025	Overcurrent/short circuit in island L2	Device switches off.	Overcurrent/short circuit in island L2	Check loads and fuses in micro-grid.	AC-DC module
50026	Overcurrent/short circuit in island L3	Device switches off.	Overcurrent/short circuit in island L3	Check loads and fuses in micro-grid.	AC-DC module
50030	DC current component L1 too high.	Device switches off.	DC current component L1 too high.	Contact service.	AC-DC module
50031	DC current component L2 too high.	Device switches off.	DC current component L2 too high.	Contact service.	AC-DC module
50032	DC current component L3 too high.	Device switches off.	DC current component L3 too high.	Contact service.	AC-DC module
50033	Grid frequency too high.	No operation possible.	Grid frequency too high.	Check the grid frequency.	AC-DC module
50034	Grid frequency too low.	No operation possible.	Grid frequency too low.	Check the grid frequency.	AC-DC module
50036	Synchronization to grid failed.	No operation possible.	Internal filter capacitor voltage and grid voltage do not line up.	Check grid settings and AC-connection (alignment of power and sense lines)	AC-DC module
50037	DC link voltage too low for operation.	No operation possible.	DC link voltage too low for operation.	Check DC link settings and wiring.	AC-DC module
50038	DC link unbalanced.	No operation possible.	DC link unbalanced.	Check DC link settings and wiring.	AC-DC module
50041	Overcurrent L1 RMS.	Device switches off.	Overcurrent L1 RMS.	Check cabling of L1, grid voltage sense lines and AC contactor.	AC-DC module
50042	Overcurrent L2 RMS.	Device switches off.	Overcurrent L2 RMS.	Check cabling of L2, grid voltage sense lines and AC contactor.	AC-DC module
50043	Overcurrent L3 RMS.	Device switches off.	Overcurrent L3 RMS.	Check cabling of L3, grid voltage sense lines and AC contactor.	AC-DC module
50044	Overcurrent balancer RMS.	Device switches off.	Overcurrent balancer RMS.	Contact service.	AC-DC module
50047	Overvoltage L1 RMS.	No operation possible.	Overvoltage L1 RMS.	Check grid settings, grid voltage L1 and external devices.	AC-DC module
50048	Overvoltage L2 RMS.	No operation possible.	Overvoltage L2 RMS.	Check grid settings, grid voltage L2 and external devices.	AC-DC module

Number	Message	Effect	Cause	Action	Detected by
50049	Overvoltage L3 RMS.	No operation possible.	Overvoltage L3 RMS.	Check grid settings, grid voltage L3 and external devices.	AC-DC module
50050	Undervoltage L1 RMS.	No operation possible.	Undervoltage L1 RMS.	Check grid settings, grid voltage L1 and external devices.	AC-DC module
50051	Undervoltage L2 RMS.	No operation possible.	Undervoltage L2 RMS.	Check grid settings, grid voltage L2 and external devices.	AC-DC module
50052	Undervoltage L3 RMS.	No operation possible.	Undervoltage L3 RMS.	Check grid settings, grid voltage L3 and external devices.	AC-DC module
50053	Grid contactor could not be closed.	No operation possible.	Grid contactor could not be closed.	Check the contactor, delaytime, cabling, AUX-supply of contactor etc.	AC-DC module
50068	Subslave communication alarm.	No operation possible.	Subslave communication alarm.	Check cabling to slaves and system start-up routine.	AC-DC module
50069	Master communication alarm.	No operation possible.	Master communication alarm.	Check cabling to master and system start-up routine.	AC-DC module
50080	Overvoltage grid N to PE.	No operation possible.	Overvoltage grid N to PE.	Check voltage N to PE, N and PE connections.	AC-DC module
50081	Overvoltage internal DC link.	Device switches off.	Overvoltage internal DC link.	Contact service.	AC-DC module
50082	Overvoltage internal N to PE.	Device switches off.	Overvoltage internal N to PE.	Contact service.	AC-DC module
50083	Overvoltage external DC link positive part.	Device switches off.	Overvoltage external DC link positive part.	Check DC link voltage and midpoint.	AC-DC module
50084	Overvoltage external DC link negative part.	Device switches off.	Overvoltage external DC link negative part.	Check DC link voltage and midpoint.	AC-DC module
50085	Overvoltage external DC link.	Device switches off.	Overvoltage external DC link negative part.	Check DC link voltage and midpoint.	AC-DC module
50086	Overvoltage external DC link midpoint to PE.	Device switches off.	DC link is unsymetric.	Check DC link voltage and midpoint.	AC-DC module
50087	Wrong polarity on DC link detected.	Device switches off.	Wrong polarity on DC link detected.	Check DC link polarity.	AC-DC module
50088	Overvoltage external 24-V auxiliary supply.	Device switches off.	Overvoltage external 24-V auxiliary supply.	Check the external 24-V auxiliary supply.	AC-DC module
50089	Undervoltage external 24-V auxiliary supply.	Device switches off.	Undervoltage external 24-V auxiliary supply.	Check the external 24-V auxiliary supply.	AC-DC module
50095	AC-DC module hardware protection alarm.	Device switches off.	AC-DC module hardware protection alarm.	Check for other error messages.	AC-DC module
50096	DC link precharge unit alarm.	No operation possible.	Precharge unit failed.	Contact service.	AC-DC module

Number	Message	Effect	Cause	Action	Detected by
50097	DC link discharge unit alarm.	No operation possible.	Discharge unit failed or balancer failed.	Contact service.	AC-DC module
50098	DC link could not be charged.	No operation possible.	Charging of DC link bus failed.	Check DC link bus and cabling of connected components.	AC-DC module
50100	DC link relay could not be closed.	No operation possible.	DC link relay could not be closed.	Check external DC link voltage.	AC-DC module
50101	DC link relay was forced to disconnect.	Device switches off.	DC link relay was forced to disconnect.	Check external DC link.	AC-DC module
50102	Fan alarm.	No operation possible.	Fan is defective or stuck.	Check the fan.	AC-DC module
50115	Overvoltage filter capacitor L1 RMS.	Device switches off.	Overvoltage filter capacitor L1 RMS.	Check grid settings, grid voltage L1 and external devices.	AC-DC module
50116	Overvoltage filter capacitor L2 RMS.	Device switches off.	Overvoltage filter capacitor L2 RMS.	Check grid settings, grid voltage L2 and external devices.	AC-DC module
50117	Overvoltage filter capacitor L3 RMS.	Device switches off.	Overvoltage filter capacitor L3 RMS.	Check grid settings, grid voltage L3 and external devices.	AC-DC module
50118	Anti-island detection alarm L1.	Device switches off.	Anti-island detection alarm L1.	Check grid settings and the installation.	AC-DC module
50119	Anti-island detection alarm L2.	Device switches off.	Anti-island detection alarm L2.	Check grid settings and the installation.	AC-DC module
50120	Anti-island detection alarm L3.	Device switches off.	Anti-island detection alarm L3.	Check grid settings and the installation.	AC-DC module
50121	Mismatch of internal and external N.	No operation possible.	Mismatch of internal and external N.	Check cabling of N and PE.	AC-DC module
50130	DC link relay disconnect not allowed - DC link voltage unstable.	Failed to disconnect from DC-Link.	DC link relay disconnect not allowed - DC link voltage unstable.	Check DC link.	AC-DC module
50131	Grid code ride through time exceeded.	Device switches off.	Grid code ride through time exceeded.	Review grid code settings. Ride throughs can be part of active grid code).	AC-DC module
50132	Grid does not match grid code requirements.	No operation possible.	Grid does not match grid code requirements (voltage and frequency).	Review grid code settings. Requirements for voltage and frequency can be part of active grid code).	AC-DC module
50134	Overload capability exceeded	Device switches off.	Overload capability exceeded	Reduce load in island mode operation.	AC-DC module
50135	Overcurrent capability exceeded	Device switches off.	Overcurrent capability exceeded	Reduce load in island mode operation.	AC-DC module
60090	Battery overvoltage.	No operation possible.	Battery voltage too high.	Check battery voltage.	DC-DC module
60093	DC link overvoltage.	No operation possible.	DC link voltage too high.	Check DC link.	DC-DC module

Number	Message	Effect	Cause	Action	Detected by
60102	DC link voltage too low for operation.	No operation possible.	DC link voltage too low.	Check DC link pre-charge.	DC-DC module
60129	Battery voltage under threshold setting.	No operation possible.	Battery voltage under threshold setting.	Change battery threshold setting.	DC-DC module
60132	RS-485 communication alarm.	No operation possible.	Communication problem on RS-485 bus.	Check RS-485 communication.	DC-DC module
60142	Battery undervoltage.	No operation possible.	Battery voltage too low.	Check battery voltage.	DC-DC module
60145	Wrong polarity on DC terminal detected.	Risk of damaging hardware.	Wrong polarity on battery detected.	Check battery polarity.	DC-DC module
60150	Battery voltage over threshold setting.	No operation possible.	Battery voltage over threshold setting.	Change battery threshold setting.	DC-DC module
60168	Ambient temperature over allowed range.	No operation possible.	Ambient temperature over allowed range.	Check the ambient temperature.	DC-DC module
60186	Ambient temperature under allowed range.	No operation possible.	Ambient temperature under allowed range.	Check the ambient temperature.	DC-DC module
60192	Fan defective or stuck.	No operation possible.	Fan is defective or stuck.	Check fan.	DC-DC module
60200	Precharge conditions could not be met.	No operation possible.	Precharge conditions could not be met.	Check droop-mode settings, DC link and battery voltage.	DC-DC module
60201	Attached load on DC link can not be handled.	No operation possible.	Attached load on DC link can not be handled.	Reduce DC link load or change pre-charge procedure.	DC-DC module
60202	DC link could not be charged	No operation possible.	DC link could not be charged	Check DC link and connected components.	DC-DC module
60700	Auxiliary supply overvoltage.	Risk of damaging hardware.	Auxiliary supply voltage too high.	Check the external 24-V auxiliary supply.	DC-DC module
60703	Auxiliary supply undervoltage.	Unstable system.	Auxiliary supply voltage too low.	Check the external 24-V auxiliary supply.	DC-DC module

AC-DC alarm messages

Tab. 39

Warning messages

Number	Message	Caused by
10016	Power failure of 24-V auxiliary supply has been detected.	System control

Warning messages

Tab. 40