

1923— 2023

100 YEARS OF TRUMPF
ANNUAL REPORT 2022|23



TRUMPF GROUP KEY FIGURES

	2021/22	2022/23	Change from 2021/22 in percent
SALES REVENUES in million euros	4,222.8	5,364.5	+27.0
ORDER INTAKE in million euros	5,577.4	5,088.0	-8.8
EBIT in million euros	468.4	615.4	+31.4
EBIT MARGIN in percent	11.1	11.5	+3.4
INVESTMENTS in million euros	218.2	315.7	+44.7
RESEARCH AND DEVELOPMENT COSTS in million euros	448.0	476.3	+6.3
BALANCE SHEET TOTAL in million euros	4,586.1	5,019.1	+9.4
EQUITY in million euros	2,387.1	2,700.4	+13.1
EQUITY RATIO in percent	52.1	53.8	+3.3
ECONOMIC EQUITY* in million euros	2,500.1	2,709.9	+8.4
ECONOMIC EQUITY RATIO in percent	54.5	54.0	-0.9
EMPLOYEES ON JUNE 30 number	16,554	18,352	+10.9

* Equity capital plus long-term loans from partners



1923– 2023

100 YEARS OF TRUMPF
ANNUAL REPORT 2022|23



100

1923- 2023

100 YEARS OF TRUMPF
ANNUAL REPORT 2022|23



1923 — 2023

DEAR READERS,

TRUMPF is one hundred years old!

For my colleagues on the Managing Board and me, this is more than ever an occasion to say thank you: Thank you to our customers and partners who have remained loyal to us for a century, in good times and in not so good times! Thank you to our over 18.000 employees at more than 80 locations worldwide, who once again gave their all for TRUMPF this past fiscal year 2022/23! Thank you to the many people who have contributed their passion and imagination to our company on its way from a 'garage factory' in Stuttgart in 1923 to a global technology company!

Anniversaries should not be a time for nostalgia, but an incentive to look to the future. Nevertheless, as our centennial year draws to a close, this annual report is dedicated to milestones in our corporate history. Optimism remains a duty – a phrase that my father quoted throughout his life in reference to Erich Kästner's famous short novel "Fabian", set at the height of the Great Depression at the end of the 1920s. It applies all the more to what lies ahead in a world that is changing.

The fact that we had a very good fiscal year with an (albeit declining) order intake of 5.1 billion euros and rising sales revenues of 5.4 billion euros despite ongoing effects from the coronavirus pandemic, supply chain problems, and the consequences of the Russian war of aggression against Ukraine, speaks for TRUMPF's strength and ability to adapt. Earnings before interest and taxes of 615 million euros and a margin of 11.5 percent top off our fiscal year 2022/23.

I hope you enjoy this journey through 100 years of TRUMPF in words and pictures.

Nicola Leibinger-Kammüller

CONTENTS

1923–1945 HOW IT ALL BEGAN ————— Page 8

1945–1962 NEW BEGINNINGS AND ECONOMIC MIRACLE — Page 16

1963–1977 TRUMPF DISCOVERS THE WORLD ————— Page 26

1978–1988 ERA OF THE INDUSTRIAL LASER ————— Page 38

1989–1999 FALL OF THE BERLIN WALL AND REUNIFICATION — Page 46

2000–2010 MILLENNIUM PERIOD ————— Page 58

2011–2022 AGE OF MICROELECTRONICS ————— Page 70

2023 CENTENNIAL YEAR ————— Page 78

LOOKING TO TOMORROW THE FUTURE WITH TRUMPF — Page 88

1923

2023

COMPANY ————— Page 100

SUSTAINABILITY ————— Page 115

GROUP MANAGEMENT REPORT ————— Page 129

CONSOLIDATED ANNUAL FINANCIAL STATEMENTS — Page 149

IMPRINT ————— Page 176

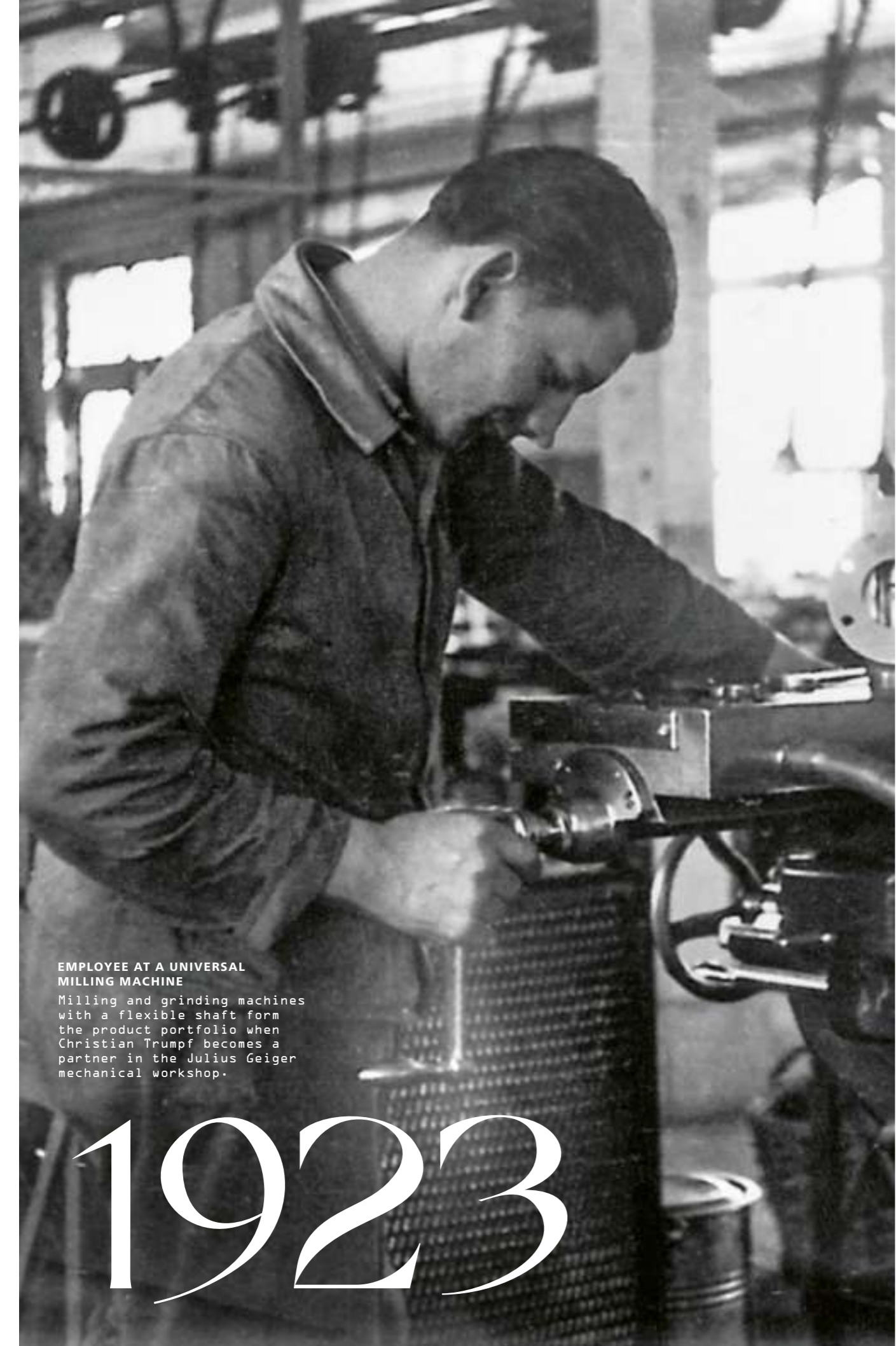

EMPLOYEE AT A UNIVERSAL MILLING MACHINE

Milling and grinding machines with a flexible shaft form the product portfolio when Christian Trumpf becomes a partner in the Julius Geiger mechanical workshop.

1923

2023

WORKING IN THE DIGITAL AGE
Today, production at TRUMPF is digitally networked throughout. Working on computers is part of the daily routine and improves the efficiency and quality of production.



Stuttgart Weilimdorf



HOW IT ALL BEGAN

- Empire State Building
- Time Magazine
- Fritz Lang "Metropolis"
- Orson Welles "Citizen Kane"
- VW Beetle
- Stock market crash
- Second World War
- Weimar Republic
- Thomas Mann Nobel Prize in Literature
- Marcel Breuer "Wassily Chair"
- Charlie Chaplin "Modern Times"
- Mies van der Rohe "Barcelona Pavilion"
- Erich Maria Remarque "All Quiet on the Western Front"
- Hyperinflation
- Pablo Picasso "Guernica"
- Mickey Mouse
- Konrad Zuse Z3 computer
- Weissenhof Estate Stuttgart
- Heisenberg, Born, and Jordan: Fundamentals of quantum mechanics

1923— 1945

THE FIRST NEW LOCATION
 In July 1933, Christian Trumpf acquires the factory building of José del Monte's insolvent cardboard box factory at Josenhansstrasse 11 in the Stuttgart suburb of Weilimdorf. The cost: 30,000 Reichsmarks.

Stuttgart Weilimdorf BEGAN

Empire State Building

Time Magazine

Orson Welles "Citizen Kane"

Fritz Lang "Metropolis"

VW Beetle

Stock market crash

Weimar Republic

Second World War

Thomas Mann Nobel Prize in Literature

Marcel Breuer "Massiv Chair"

Charlie Chaplin "Modern Times"

Mies van der Rohe "Barcelona Pavilion"

Erich Maria Remarque "All Quiet on the Western Front"

Hyperinflation

Mickey Mouse

Pablo Picasso "Guernica"

Konrad Zuse Z3 computer

Weissenhof Estate Stuttgart

Heisenberg, Born, and Jordan: Fundamentals of quantum mechanics

1933 1945



THE FIRST NEW LOCATION

In July 1933, Christian Trumpf acquires the factory building of José del Monte's insolvent cardboard box factory at Josenhansstrasse 11 in the Stuttgart suburb of Weilimdorf. The cost: 30,000 Reichsmarks.

**MANUAL WORK**

Employees in the Weillimdorf production hall in the mid-1930s producing universal machines with flexible shafts. Various attachments for the shafts can be seen on the workbench: milling cutters, files, grinders and drills.

Solidarity



SECURITY FOR THE WORKFORCE

Employees in production, during a break in the yard at the Weilimdorf factory, and testing the machines. Bottom right: Trumpf (2nd from right), was born in 1892 in Forchtenberg in the Hohenlohe district. The picture shows him in 1934 on the annual company outing standing among his workforce. Despite the patriarchal management style common in those days, Christian Trumpf attaches great importance to a sense of solidarity among his employees and social security. In 1938, he sets up a company provident fund for his retired workers. From 1952 onwards, he pays out a profit share.

HOW IT ALL BEGAN

"We are impoverished, so impoverished. The number of those who cannot earn their daily bread has never been greater." This is how Chancellor Wilhelm Marx describes the dramatic economic situation in the Weimar Republic in his Christmas speech in 1923. An egg that already costs 800 Marks in June would see its price go up to 320 billion Marks by the end of the year. To be able to keep up with this drastic drop in the value of money, employers pay wages twice a day.

In the middle of this hyperinflation, Christian Trumpf joins Julius Geiger GmbH – a small mechanical workshop with five employees at Gutenbergstrasse 38 in the Stuttgart-West district. The young businessman doesn't secure his investment in the company with worthless money, but with 29 vices and 1,300 kilograms of wire. The small company needs this wire for the production of flexible shafts, which are initially used by dentists for their devices. Further development for the industrial processing of metal and wood soon takes place.

THE GOLDEN TWENTIES

Economic stabilization follows, and with it the Golden Twenties, a time shaped by technology, utopias, music, film, architecture and art. Besides Berlin, Stuttgart is also a center of the avant-garde: architect Le Corbusier takes part in the construction of the Weissenhof Estate, painter Willi Baumeister achieves international fame, and actress and singer Josephine Baker performs in the Friedrichsbau Varieté theater. In this spirit of optimism, Berthold Leibinger's parents, Emma and Anton Leibinger, open a shop selling East Asian antiques in the Königsbau in the center of Stuttgart.

The Trumpfs, who are art collectors, visit the shop frequently, and their shared passion for Japan leads to a friendship between the two couples. Anna Trumpf becomes godmother to Berthold Leibinger, who is born in 1930.

Times are golden for Christian Trumpf and his mechanical workshop too. He is quick to recognize the importance of innovations and international sales, and the company has his entrepreneurial foresight to thank for its rapid rise to a small, medium-sized industrial company with 70 employees in 1928.

As the global economic crisis looms in 1929, however, the company goes through difficult times, with declining orders and short-time working becoming the rule. But despite a significant drop in sales and losses, Trumpf is optimistic about the future. In 1933 he decides to move the company headquarters from the cramped backyard in Stuttgart to Weilimdorf, where the factory building of a former cardboard box factory is for sale. In the new premises, Trumpf expands the company's product portfolio in 1934: the first electric hand shears that are developed can be used to cut sheet metal up to a thickness of 1.2 mm.

The business success of Christian Trumpf ultimately results in the partners renaming the company to "TRUMPF & Co. formerly Julius Geiger" in 1937.

DARK TIMES

Like many mechanical and electrical engineering companies flourishing during the Second World War, TRUMPF is involved in the National Socialist armaments industry. The company maintains its product range of electric hand shears and flexible shafts even during the war. All major aircraft factories and some car manufacturers too are buyers of manual plate shears.

But the company also contributes directly to wartime production, producing foot pumps for aircraft as a sub-supplier to Mahle subsidiary Elektron-Co. mbH. TRUMPF maintains its entire production throughout the war.

Among the up to 150 employees are 34 French and two Italian forced laborers. The so-called 'civilian workers' live directly on the company premises, in a specially built hut. They leave the company immediately after the invasion of French troops in April 1945.

At Berthold Leibinger's personal request, TRUMPF joins the German business foundation initiative "Remembrance, Responsibility and Future" in December 1999. The foundation contributes to the financial compensation of former forced laborers.

Universal-Maschinen mit der großen Motorleistung bis 1,5 PS und 13 Drehzahlen von 1000 bis 40000/Min. erleichtern die hochwertige Handarbeit, so daß der Arbeiter mehr und Besseres leisten kann.

1923— 1945

TRUMPF & CO. VORM. JULIUS GEIGER STUTTGART WEILIMDORF

HOW THE ALL Solidarity BEGAN

As the global economic crisis looms in 1929, however, the company goes through difficult times, with declining orders and short-time working becoming the rule. But despite a significant drop in sales and losses, Trumpf is optimistic about the future. In 1933 he decides to move the company headquarters from the cramped building in Stuttgart to Weilimdorf, where the factory building of a former cardboard box factory is for sale. In the new premises, Trumpf expands the company's product portfolio in 1934: the first electric hand shears that are developed can be used to cut sheet metal up to a thickness of 1.2 mm. The business success of Christian Trumpf ultimately results in the partners renaming the company to "TRUMPF & Co., formerly Julius Geiger" in 1937.

DARK TIMES

Like many mechanical and electrical engineering companies flourishing during the second World War, TRUMPF is involved in the National Socialist armaments industry. The company maintains its production of electric hand shears and flexible shafts even during the war. All major aircraft factories and some car manufacturers too are buyers of manual plate shears.

But the company also contributes directly to wartime production, producing foot pumps for aircraft as a sub-supplier to Mahle subsidiary Elektron-Co. GmbH, TRUMPF maintains its entire production throughout the war. Among the up to 150 employees are 34 French and two Italian forced laborers. The so-called civilian workers live directly on the company premises, in a specially built hut. They leave the company immediately after the invasion of French troops in April 1945.

At Berthold Leindinger's personal request, TRUMPF joins the German business foundation initiative "Remembrance, Responsibility and Future" in December 1999. The foundation contributes to the financial compensation of former forced laborers.

"We are impoverished, so impoverished. The number of those who cannot earn their daily bread has never been greater." This is how Chancellor Wilhelm Marx describes the dramatic economic situation in the Weimar Republic in his Christmas speech in 1923. An egg that already costs 800 Marks in June would see its price go up to 320 billion Marks by the end of the year. To be able to keep up with this drastic drop in the value of money, employers pay wages twice a day.

In the middle of this hyperinflation, Christian Trumpf joins Julius Geiger GmbH – a small mechanical workshop with five employees at Gutenbergstraße in the Stuttgart-West district. The young businessman doesn't secure his investment in the company with worthless money, but with 29 vices and 1300 kilograms of wire. The small company needs this wire for the production of flexible shafts, which are initially used by dentists for their devices. Further development for the industrial processing of metal and wood soon takes place.

THE GOLDEN TWENTIES

Economic stabilization follows, and with it the Golden Twenties, a time shaped by technology, utopias, music, film, architecture and art. Besides Berlin, Stuttgart is also a center of the avant-garde: architect Le Corbusier takes part in the construction of the Weissenhof Estate, painter Willi Baumeister achieves international fame, and actress and singer Josephine Baker performs in the Friedrichsbau Variété theater. In this spirit of optimism, Berthold Leindinger's parents, Emma and Anton Leindinger, open a shop selling East Asian antiques in the Königspalast in the center of Stuttgart.

The Trumpf, who are art collectors, visit the shop frequently, and their shared passion for Japan leads to a friendship between the two couples. Anna Trumpf becomes godmother to Berthold Leindinger, who is born in 1930.

Times are golden for Christian Trumpf and his mechanical workshop too. He is quick to recognize the importance of innovations and international sales, and the company has his entrepreneurial foresight to thank for its rapid rise to a small, medium-sized industrial company with 70 employees in 1928.

SECURITY FOR THE WORKFORCE

Employees in production, during a break in the yard at the Weilimdorf factory, are testing the machine. Bottom right: Trumpf (2nd from right), was born in 1887 in Fichtenberg in the Hohenlohe district. The picture shows him in 1911 on the annual company outing standing among his workforce. Despite the patriarchal management style common in those days, Christian Trumpf attaches great importance to a sense of solidarity among his employees and social security. In 1928, he sets up a company provident fund for his retired workers. From 1952 onwards, he pays out a profit share.

Sie machen Formen

Kokillen, Gesenke, Modelle?

Oder müssen Sie Gußstücke, besonders **LEICHTMETALLGUSS** verputzen, glätten, entgraten lassen?

TRUMPF

Universal-Maschinen mit der großen Motorleistung bis 1,5 PS und 13 Drehzahlen von 1000 bis 40000/Min. erleichtern die hochwertige Handarbeit, so daß der Arbeiter mehr und Besseres leisten kann.

Shears & shafts



SHEET METAL HAND TOOL

TRUMPF has been manufacturing various electric hand shears since 1934. At a trade show booth in 1937, the company presents its product portfolio of universal machines with a flexible shaft.

TRUMPF

TECHNOLOGY HIGHLIGHT

Fräser, lieferbar in 5 Zahnungen u. 57 Formen

Feilen, lieferbar in 4 Hiebarten und 28 Formen

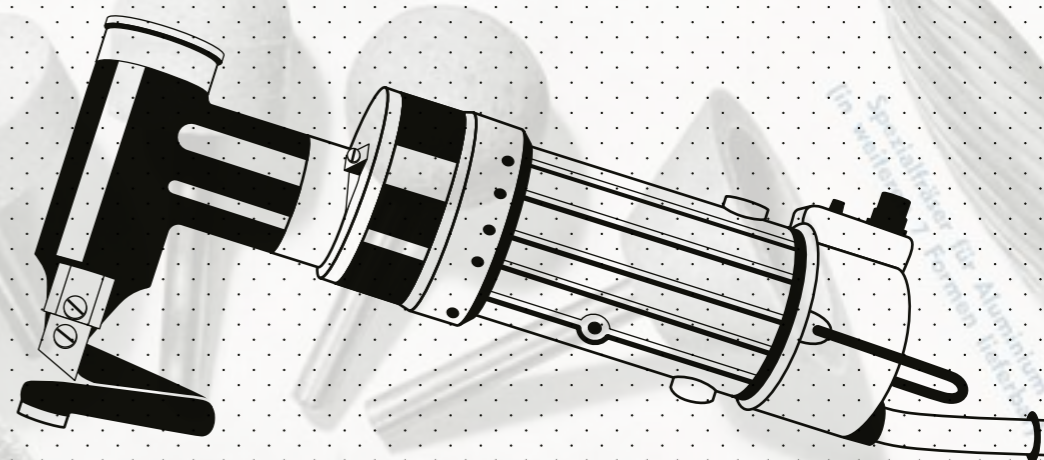

Schleifprofile, lieferbar in 50 Formen

Spezialwerkzeuge für Aluminium
in verschiedenen Ausführungen

Drahtbürste

ELECTRIC HAND SHEARS HSU 1.5

Electric hand shears with a 25-watt universal motor cut sheets up to 1.5 mm at about 1,500 cuts per minute. They cut cleanly, quickly, and reliably with hardly any hand fatigue, and can even cut small curvatures with a radius of 10 to 20 mm without any problems. The electric hand shears are driven by a universal motor that can be connected to any branch circuit with a plug.

The design features a simple shear gear consisting of a few sturdy parts. The lower blade moves straight up and down against the upper fixed blade by means of a double-bearing eccentric. The clean and burr-free cut eliminates the need for post-treatment.

2 kg Weight
13 cm Height
1.5 mm Cutting performance

TRUMPF

Shears & shafts



The design features a simple shear gear consisting of a few steel parts. The lower shaft is a simple gear with a few teeth. The upper shaft is a simple gear with a few teeth. The design is simple and clean and provides a high quality product.



Fräser, lieferbar in 5 Zahnungen u. 57 Formen



Feilen, lieferbar in 4 Hiebarten und 28 Formen



Schleifprofile, lieferbar in 50 Formen

Spezialfräser für Aluminium (in weiteren 7 Formen lieferbar)



Drahtbürste

Elastische Schleifscheibe

Filmpolierkörper



Fibre-Polierscheibe

In series

NEW BEGIN- NINGS AND ECONOMIC MIRACLE

LEGO

Sputnik

Verner Panton "Panton Chair"

NATO

Atomic bombs dropped on Hiroshima and Nagasaki

Cuban Missile Crisis

IBM hard drive

United Nations

Polaroid camera

Marshall Plan

GDR

Louis Poulsen "PH Artichoke Lamp"

FRG

Rock'n'Roll

Video recorder

"Tennis for Two" video game

Fuel cell

European Parliament

Theodore Maiman: first laser

Term 'AI'

Andy Warhol "Campbell's Tomato Soup"

Charles and Ray Eames "Lounge Chair"

Berlin Wall

1945- 1962

JACK OF ALL TRADES

The TRUMPF stationary curve shears (TAS) can punch as well as nibble. They can be used to make cuts without pre-punching the center of the sheet and to produce complicated shapes.





1958
Paris

Growth



INVESTMENT IN EDUCATION

With the economic upturn after the war, the number of employees also grows. TRUMPF invests in a new office building at the Weillimdorf location and expands the training workshop. In 1950, families also come along on the annual company outing.

NEW BEGINNINGS AND ECONOMIC MIRACLE

The Second World War ends in Europe in May 1945. The consequences of the war can be felt everywhere. The victorious powers divide Germany into four occupation zones. Millions of men are prisoners of war or have died in the war. Many large cities are in ruins after air raids, and living space is scarce. Refugees and expellees from the East stream into the occupation zones. There is a lack of essential goods for the population such as food and clothes; the power supply is difficult.

In order to quickly boost reconstruction, the Stuttgart Economic Office grants permission in August 1945 for the production of power tools to resume. Initially, it only applies to the food sector and the railways. Christian Trumpf has a decisive starting advantage: he has an undamaged factory. In 1947, he develops his first machine, the stationary curve shears, TAS. He quickly manages to exceed the one-million sales mark. The move into stationary sheet metal processing means that the flexible shaft no longer fits into the company's logo. From this point on, it is replaced by a 'trump' card in the shape of an ace of spades as a play on the alternative meaning of the company's name.

PARTITION AND PROSPERITY

The partition of Germany progresses as a result of the East-West divide. In May 1949, the Federal Republic of Germany (FRG) is founded, and in October, the German Democratic Republic (GDR) is constituted as the second German state.

The demand for cars, mopeds, washing machines and radios also steadily boosts production at TRUMPF. Christian Trumpf recognizes that participation in domestic and foreign trade shows is an important instrument for promoting sales. So in 1951, TRUMPF exhibits its products at the first 'Exposition Européenne de la Machine-Outil', a mechanical engineering trade fair in Paris. This is quickly followed by trade show appearances in North and South America, Australia and Japan.

When in 1955 the millionth Beetle rolls off the production line in Wolfsburg as a symbol of the economic miracle, TRUMPF opens a new factory in Hettingen in the Swabian Alb, a picturesque corner of southwest Germany. Increasing sales of large machine tools from the TAS series require more space than is available in the factory halls in Weillimdorf.

METAL CHIPS

An apprentice produces a workpiece on a milling machine in the training workshop in Hettingen.

TRUMPF IS CROWNED THE "NIBBLING KING" BY THE PRESS

TRUMPF's growing success as a machine tool builder is closely linked to the young engineer Berthold Leibinger. Leibinger completes a training program at the company of his godfather Christian Trumpf as early as 1950 and writes his diploma thesis in 1956. The CN 63 copy nibbling machine he designs, which operates automatically for the first time thanks to a mechanical design, proves to be a magnet for visitors at the 1957 spring trade show in Leipzig. For this reason, the trade press refers to TRUMPF as the "nibbling king" in the years that follow.

Despite his success in Germany, it remains a great dream for young inventor Berthold Leibinger to live and work in America. At the end of 1958, he and his wife Doris set off for Wilmington (Ohio), where he works for two years as a development engineer at the Cincinnati Milling Machine Company, the largest machine tool factory in the world at the time.

In spite of this job, Leibinger always keeps his eyes open at trade shows and on business trips for new technologies that he considers important for TRUMPF.

To this end, he stays in close contact with the Cosa Corporation, TRUMPF's commercial agency in the US at the time. But Berthold Leibinger is also in constant correspondence with TRUMPF in Weillimdorf. On a small drawing board that he buys for a few dollars, Leibinger designs a copy punch. He comments on designs from Weillimdorf that are intended to improve the copy nibbler and the newly introduced hand nibbler. His wife Doris Leibinger types the texts on her travel typewriter called 'Erika'.

Looking back, Leibinger comments: "Cincinnati Milling, my employer, was in a different league from a technical and business point of view. But my technical heart belonged to TRUMPF."

So it's no surprise that Leibinger takes over as head of TRUMPF's design department after his return to Germany in January 1961.

1945— 1962

MIRACLE AND ECONOMIC GROWTH NEW BEGINNINGS

TRUMPF IS CROWNED THE "NIBBLING KING" BY THE PRESS

TRUMPF's growing success as a machine tool builder is closely linked to the young engineer Berthold Leiding. Leiding completes a training program at the company of his godfather Christian Trumf as early as 1950 and writes his diploma thesis in 1956. The CN 63 copy nibbling machine he designs, which operates automatically for the first time thanks to a mechanical design, proves to be a magnet for visitors at the 1957 spring trade show in Leipzig. For this reason, the trade press refers to TRUMPF as the "nibbling king" in the years to follow.

Despite his success in Germany, Leiding has a great dream for young inventor Berthold Leiding: to live and work in America. At the end of 1958, he starts working for his set off for Wilmington (Ohio), where he works for years as a development engineer at the Cincinnati Milling Machine Company, the largest machine tool factory in the world at the time. In the company, he keeps his eyes on the latest developments in machine tool technology. He opens at trade shows and on business trips for new technologies that he considers important for TRUMPF.

To this end, he stays in close contact with the German Corporation, TRUMPF's commercial agency in the US at the time. But Berthold Leiding is also in constant correspondence with TRUMPF in Weillimdorf. On a small drawing board that he buys for a few dollars, Leiding designs a copy punch. He comments on designs from Weillimdorf that are intended to improve the copy nibbler and the newly introduced hand nibbler. His wife Doris Leiding types the texts on her travel typewriter called "Lila".

Looking back, Leiding remembers: "Dinner at Millington my employer was in a room with a large window. I had my business point of view on my technical heart. I belonged to TRUMPF."

So it's no surprise that Leiding takes over as head of TRUMPF's design department after his return to Germany in January 1961.

The second World War ends in Europe in May 1945. The consequences of the war can be felt everywhere. The victorious powers divide Germany into four occupation zones. Millions of men are prisoners of war or have died in the war. Many large cities are in ruins after air raids, and living space is scarce. Refugees and expelled from the East stream into the occupation zones. There is a lack of essential goods for the population such as food and clothes. The power supply is almost non-existent.

In order to restart the construction, the Stuttgart Economic Office grants permission in August 1945 for the production of power tools to resume. Initially, it only applies to the food sector and the railways. Christian Trumf has a decisive starting advantage: he has an unclaimed factory. In 1947, he develops his first machine tool, the copy punch TAT. He quickly manages to exceed the production plan. The machine tool is a stationary sheet metal processing means that the flexible shaft no longer fits into the company's logo. From this point on, it is replaced by a "trumpf" card in the company's name. an ace of spades as a play on the alternative meaning of the company's name.

PARTITION AND PROSPERITY

The partition of Germany progresses as a result of the East-West divide. In May 1949, the Federal Republic of Germany (FRG) is founded, and in October, the German Democratic Republic (GDR) is constituted as the second German state.

The demand for cars, models, washing machines and radios also steadily boosts production at TRUMPF. Christian Trumf recognizes that participation in domestic and foreign trade shows is an important instrument for promoting sales. In 1951, TRUMPF exhibits its products at the first "Exposition Européenne de la Machine-Outil", a mechanical engineering trade fair in Paris. This is quickly followed by trade show appearances in North and South America, Australia and Japan.

When the millwright Beetle rolls off the production line in Wolfsburg as a symbol of the economic miracle, TRUMPF opens a new factory in Hettlingen in the Swabian Alb, a picturesque corner of southwest Germany. Increasing sales of large machine tools from the TAT series require more space than is available in the factory halls in Weillimdorf.

With the economic upturn after the war, the number of employees also grows. TRUMPF invests in a new office building at the Weillimdorf location and expands the training workshop. In 1959, families also come along on the annual company outing.

INVESTMENT IN EDUCATION

With the economic upturn after the war, TRUMPF invests in a new office building and expands the training workshop. In 1959, the annual company outing.

1962



METAL CHIPS
An apprentice produces a workpiece on a milling machine in the training workshop in Hettlingen.



MACHINES FROM THE SWABIAN ALB

Local councilors from Hettingen on a factory tour to discuss expansion options for the location. Below: Ditzingen employees visit colleagues at the new site in Hettingen in 1956 and inspect the renovation of the building.



GRINDERS
 WITH
FLEXIBLE SHAFT



Fig. 1
Rough grinding with Sander PS 7 SAT 112 and roughing wheel

Fig. 2
Finishing with Guidance SMT 9, Grinding Handpiece 56g with Wheel Ouzel 50ch 10 and grinding wheel 130 x 30 x 12 mm 40 x 12 x 0.30 A 1

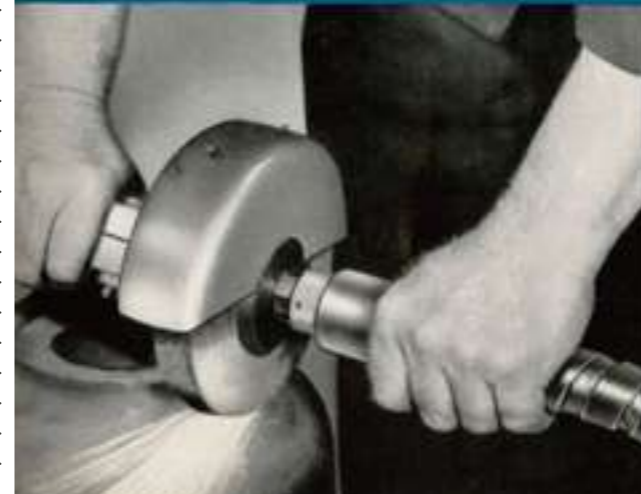

TRUMPF & CO. STUTTGART-WEILIMDORF

Western-Germany

Telegramm: Trumfwalle Stuttgart - Telephones: 88146-48 - Teletype: 07-23355

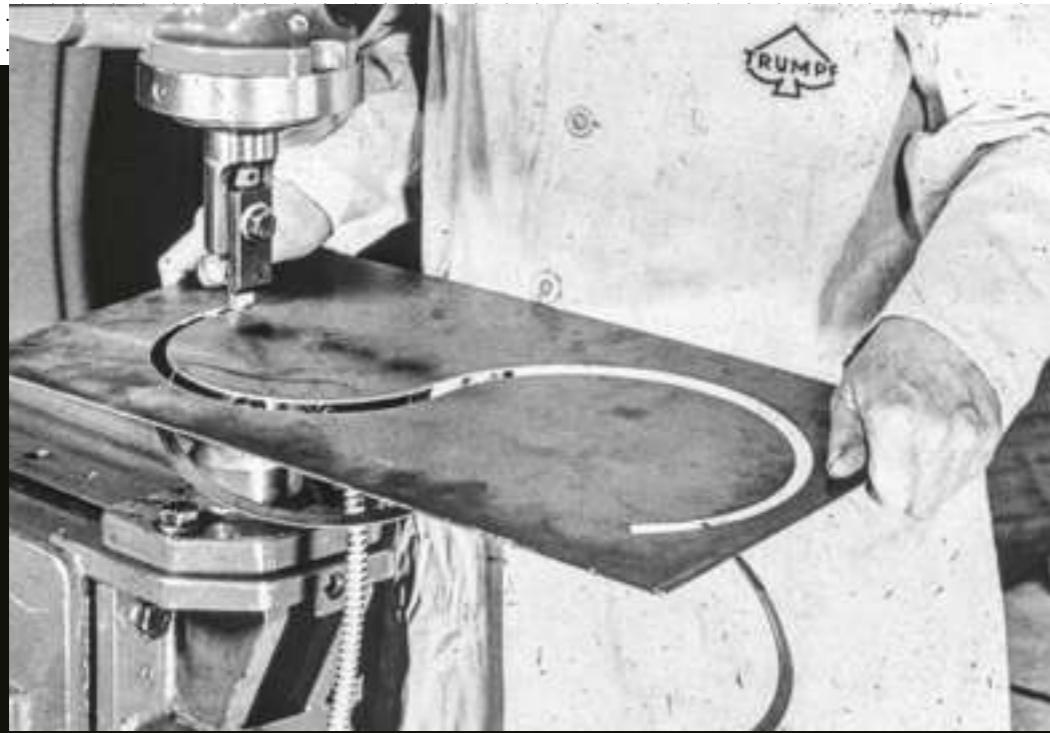

Slitting & peening

SHAPING THE STEEL

An employee makes a slit in a work-piece. Below: An employee peens a hemispherical shell.

TECHNOLOGY HIGHLIGHT

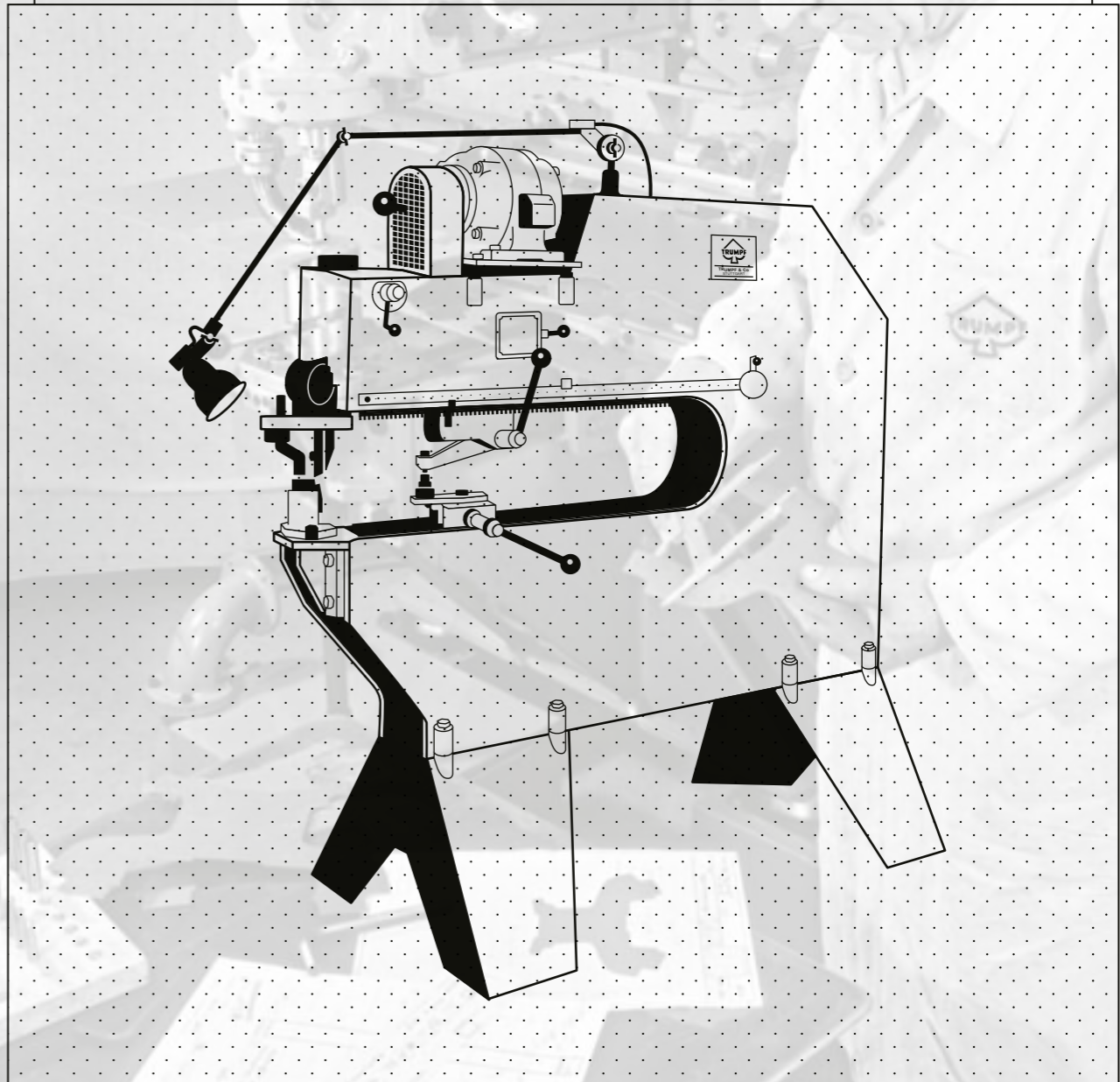

TAS 400

TRUMPF stationary curve shears (TAS) are multi-purpose machines for sheet metal and plastics processing. The machine body is designed in such a way that even highly deformed workpieces can be trimmed, sheared, beaded or louvered. The machine is used in car body construction, aeronautical engineering and in electrical and chemical equipment construction. The quick and easy tool change increases the economic efficiency of this machine. A round guide with internal centering is available for round blanks, rings and circular segments. A simple straight-line guide, which is included in the delivery, enables straight-line work. A special feature is the infinitely adjustable stroke. It can be adjusted up to 6 mm, 8 mm or 10 mm, regardless of the number of strokes or working position of the ram.

490 kg
Weight

174 cm
Height

10 mm
Sheet thickness

TRUMPF

TECHNOLOGY
HIGHLIGHT

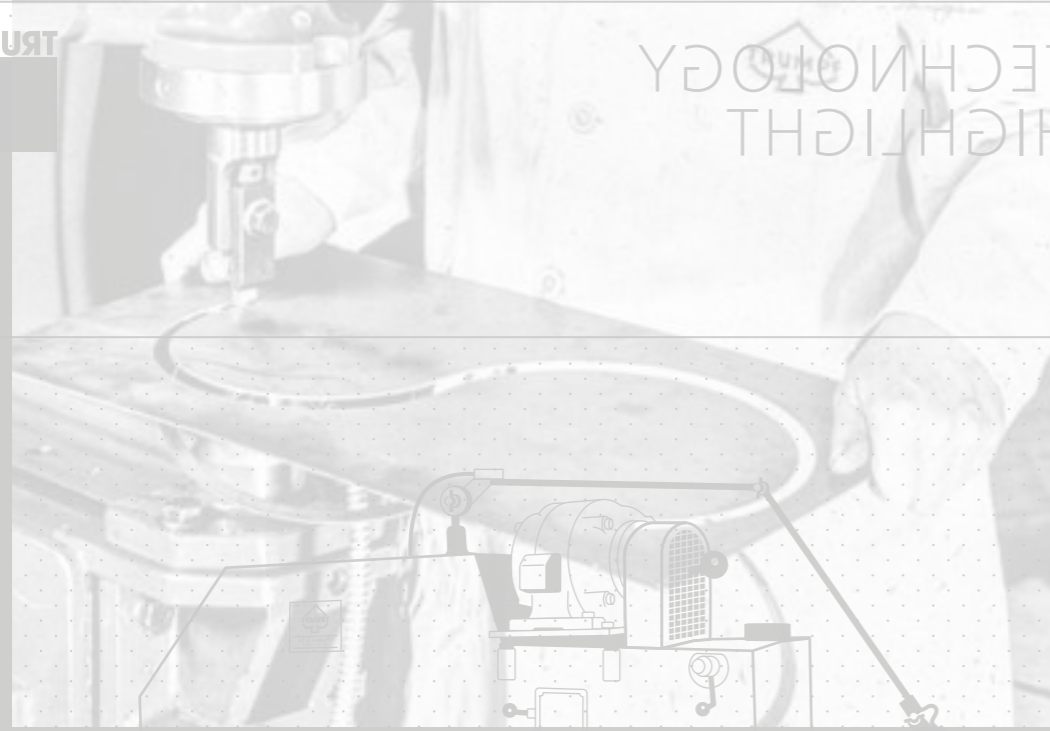

Slicing & peering

TAT 400

TRUMPF stationary curve shears (TAT) are multi-purpose machines for sheet metal and plastic processing. The machine body is designed in such a way that variously formed workpieces can be trimmed, sheared, beaded or flanged. The machine is used in electrical construction, aeronautical engineering and in electrical and chemical equipment construction. The quick and easy tool change

130 kg
Weight

SHAPING THE STEEL

An employee peens a hemispherical shell.

CALIPERS AND MEASUREMENT BY EYE

A design engineer in Ditzingen measures and inspects a workpiece produced by a copy nibbling machine. He is wearing a white coat - the traditional work attire back then.



1965 Osaka



SHOWSTOPPER FOR JAPAN

TRUMPF presents the TKF 100 beveler at its booth in Osaka. The handy power tool, which can be used for curves, enables weld seam preparation even for bulky and large workpieces with no transport or guide direction.

TRUMPF DISCOVERS THE WORLD

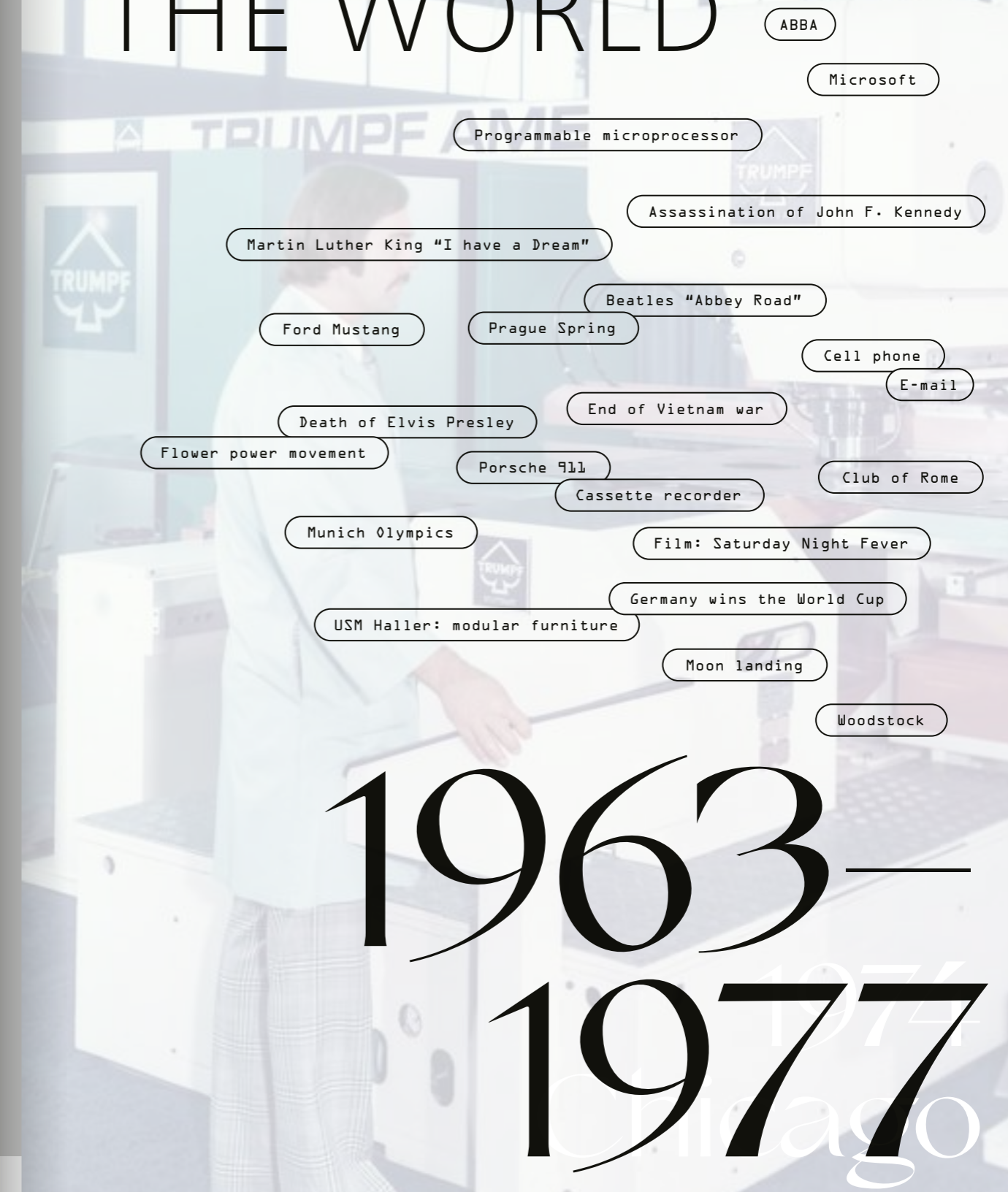

ABBA

Microsoft

Programmable microprocessor

Assassination of John F. Kennedy

Martin Luther King "I have a Dream"

Beatles "Abbey Road"

Ford Mustang

Prague Spring

Cell phone

E-mail

Death of Elvis Presley

End of Vietnam war

Flower power movement

Porsche 911

Cassette recorder

Club of Rome

Munich Olympics

Film: Saturday Night Fever

Germany wins the World Cup

USM Haller: modular furniture

Moon landing

Woodstock

1963— 1977

Chicago

TRUMPF DISCOVERS THE WORLD

ABBA

Microsoft

Programmable microprocessor

Assassination of John F. Kennedy

Martin Luther King "I have a dream"

Beatles "Abbey Road"

Prague Spring

Ford Mustang

Cell phone

E-mail

End of Vietnam war

Death of Elvis Presley

Flower power movement

Club of Rome

Cassette recorder

Porsche 911

Munich Olympics

Film: Saturday Night Fever

Germany wins the World Cup

U2M Haller: modular furniture

Moon landing

Woodstock

1973-1974

SHOW STOPPER FOR JAPAN
TRUMPF presents the KF 100 leveler at its booth in Osaka. The heavy-duty tool, which can be used for claves, enables cold seam preparation even for bulky and large workpieces with no transport guide direction.



1974 Chicago



1968
Buenos Aires

First steps towards globalization



FROM AFRICA TO SOUTH AMERICA

In 1963, French firm Technom convinces customers in Paris of the quality of TRUMPF products with a mobile demonstration vehicle. TRUMPF presents power tools at trade shows in Tel Aviv and Nairobi in 1964. The company presents a copy nibbling machine for the first time in South America at its trade show booth in São Paulo in 1963.

TRUMPF DISCOVERS THE WORLD

The 1960s are years of contrasts and change. In the midst of the Cold War, Vietnam becomes the scene of a tragic proxy war between the superpowers of the time. The first man lands on the moon. The Beatles and the Rolling Stones conquer the music world. The hippie movement rigorously challenges traditional ties and social constraints.

The mood of upheaval and desire for change can also be felt at TRUMPF.

Berthold Leibinger achieves another innovative breakthrough in 1963, shortly after becoming head of the design office. He develops the TKF 100 beveler, a beveling tool for metal edges. The power tool is a bestseller for years and achieves a sales share of 13 percent surprisingly quickly. Due to his abilities and importance for the company, the young engineer is offered shares in the company by Anna and Christian Trumpf.

Almost unnoticed, the history of the company's first major product lines comes to an end in 1964, when the partners decide to stop manufacturing the universal machines and associated flexible shafts.

THE TRIUMPH OF NUMERICAL CONTROL

With financial security thanks to high profits and his experience from the US behind him, Berthold Leibinger decides to take the bold step of developing a numerically controlled copy punching machine – against the advice of Christian Trumpf, who sees no market for such an expensive and highly complex machine. The Trumatic 20 is a sensation at the 1967 Hannover Messe. The next groundbreaking innovation follows just three years later: the first Trumatic 20 with an automatically controlled tool changer. The order books are full, and the question of where to manufacture the new, large-format machine tool quickly arises. The Weilimdorf location offers no opportunities for expansion.

PIONEERING DECISIONS

In 1968, the now 75-year-old Christian Trumpf hands over his shares and the management of the company to Berthold Leibinger and co-partner Hugo Schwarz. The new managing directors immediately tackle the construction of an administration and factory building in neighboring Ditzingen. When it opens in 1972, the new location offers 600 employees state-of-the-art working and production conditions.

The German economic miracle ends in 1973 with the first oil crisis. However, for TRUMPF, the triumphant march continues unabated. The Trumatic 20 accounts for 50 percent of total sales in the mid-1970s. Between 1973 and 1977, sales revenues increase from 49.6 to 80.9 million Deutsche Marks.

TRUMPF GOES OUT INTO THE WORLD TO ITS CUSTOMERS

During this time, TRUMPF also takes its first international steps. Until now, TRUMPF has relied on commercial agencies outside Germany, but these all have machines and products from several other companies in their sales ranges – which makes the TRUMPF partners worry that their own products are not given sufficient attention. For this reason, they turn to demonstration vehicles, which the company itself uses to convince customers on the ground of the quality of its power tools and sheet metal processing machines.

As sales abroad rise, there is also increased demand for long-term services, which the commercial agencies cannot provide. These include in particular the maintenance and repair of the machines.

So Christian Trumpf opens the first foreign sales company in Zug, Switzerland, in 1963. Then in 1969, TRUMPF America Inc. becomes the first production location outside of Europe, in Farmington/CT. Berthold Leibinger and co-partner Hugo Schwarz have initiated the founding of the American subsidiary. Additional sales companies are established in the United Kingdom (St. Albans) in 1974, and in Japan (Yokohama) and France (Gonesse near Paris) in 1977.

GENTLEMEN'S MEETING IN ENGLAND

Christian Trumpf (middle) and Berthold Leibinger (far right) visit TRUMPF's commercial agency in the UK, F.J. Edwards Ltd. in central London.

1963— 1977

First steps toward globalization

PIONEERING DECISIONS

In 1968, the now 75-year-old Christian Trumpp hands over his shares and the management of the company to Berthold Leibinger and co-partner Hugo Schwarz. The new managing directors immediately tackle the construction of an administration and factory building in the new neighborhood Ditzingen. When it opens in 1972, the new location offers 600 employees state-of-the-art working conditions and production facilities.

The German economic miracle ends in 1973 with the first oil crisis. However, for TRUMPF, the turbulent market continues unabated. The Tumatic 20 accounts for 50 percent of total sales in the mid-1970s. Between 1973 and 1977, sales revenues increase from 49.6 to 80.9 million Deutsche Marks.

TRUMPF GOES OUT INTO THE WORLD TO ITS CUSTOMERS

During this time, TRUMPF also takes its first international steps. Until now, TRUMPF has relied on commercial agencies outside Germany, but these all have machines and products from several other companies in their sales targets – which makes the TRUMPF partners worry that their own products are not given sufficient attention. For this reason, they turn to demonstration vehicles, which the company itself uses to convince customers on the ground of the quality of its power tools and sheet metal processing machines.

A sales abroad rise, there is also increased demand for long-term services, which the commercial agencies cannot provide. These include in particular the maintenance and repair of the machines.

So Christian Trumpp opens the first foreign sales company in Zug, Switzerland, in 1963. Then in 1969, TRUMPF America, Inc. becomes the first production location outside of Europe, in Farmington, CT. Berthold Leibinger and co-partner Hugo Schwarz have initiated the founding of the American subsidiary. Additional sales companies are established in the United Kingdom (St. Albans) in 1974 and in Japan (Yokohama) and France (Gonesse near Paris) in 1977.

FROM AFRICA TO SOUTH AMERICA

In 1971, French firm Thomson convinces customers in Paris of the quality of TRUMPF products with a mobile demonstration vehicle. TRUMPF presents power tools at trade shows in Tel Aviv and Nairobi in 1974. The company presents a copy nibbling machine for the first time in South America at its trade show booth in São Paulo in 1975.

1977

The 1960s are years of contrasts and change. In the midst of the Cold War, Vietnam becomes the scene of a tragic proxy war between the superpowers of the time. The first man lands on the moon. The Beatles and the Rolling Stones conquer the music world. The hippie movement rigorously challenges traditional ties and social conventions.

The mood of upheaval and desire for change can also be felt at TRUMPF.

Berthold Leibinger achieves another innovative breakthrough in 1963, shortly after becoming head of the design office. He develops the TKF 100 beveler, a beveling tool for metal edges. The power tool, a bestseller for years and achieves a sales share of 13 percent for TRUMPF. Due to his sales and importance for the company, the young engineer is offered shares in the company by Anna and Christian Trumpp.

Almost unnoticed, the history of the company's first major product lines comes to an end in 1964, when the company begins manufacturing the first metal cutting and associated flexible shafts.

THE TRIUMPH OF NUMERICAL CONTROL

With financial security thanks to high profits and his experience from the US bed firm, Berthold Leibinger decides to take the bold step of developing a numerically controlled copy punching machine – against the advice of Christian Trumpp, who sees no market for such an expensive and highly complex machine. The Tumatic 20 is a sensation at the 1967 Hannover Messe. The next groundbreaking innovation follows just three years later: the first Tumatic 20 with an automatically controlled tool changer. The order books are full, and the question of how to manufacture the new large-format machine tool quickly arises. The Weilmünster location offers no room for expansion.

359_361



GENTLEMEN'S MEETING IN ENGLAND

Christian Trumpp (middle) and Berthold Leibinger (far right) visit TRUMPF's commercial agency in the UK, F.J. Edwards Ltd. in central London.



ON THE GROUND
 TRUMPF customer service
 with its mobile
 demonstration vehicle.

Close to
 customers

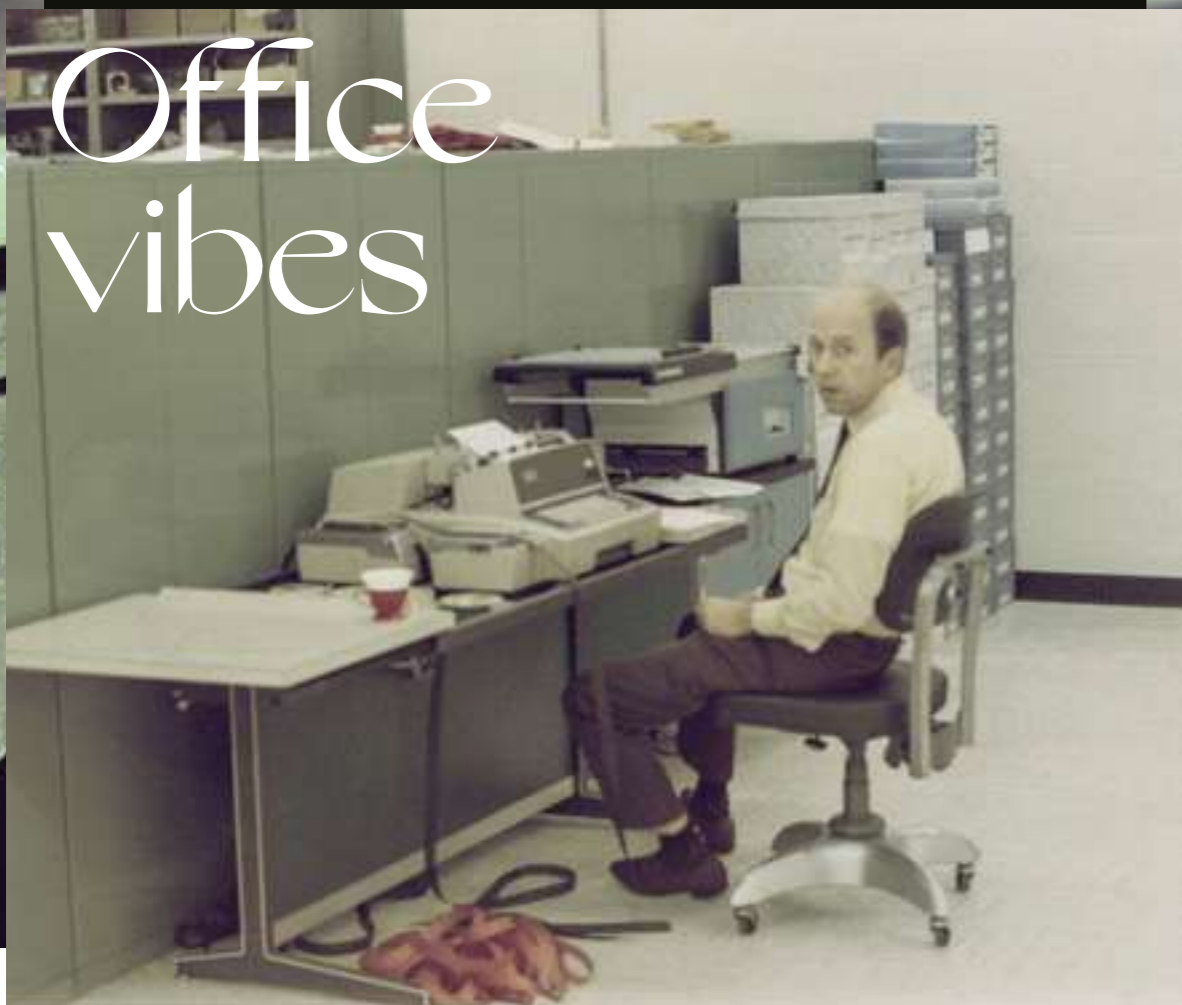

Office vibes

EVERYDAY LIFE IN THE OFFICE

(from left to right:) Managing directors and partners Hugo Schwarz and Berthold Leibinger in their office at the new company headquarters in Ditzingen. Below: An employee familiarizing himself with the latest office technology in the new Ditzingen building in 1972.

TECHNOLOGY HIGHLIGHT

TRUMPF

FIRST SETS IN OPERATION
 TRUMPF veteran "Bobby" Braun
 from Ditzingen (left) and
 Edvard Stauden
 a copy nibbling machine. Its
 transfer produces the newly
 manufactured workpiece.

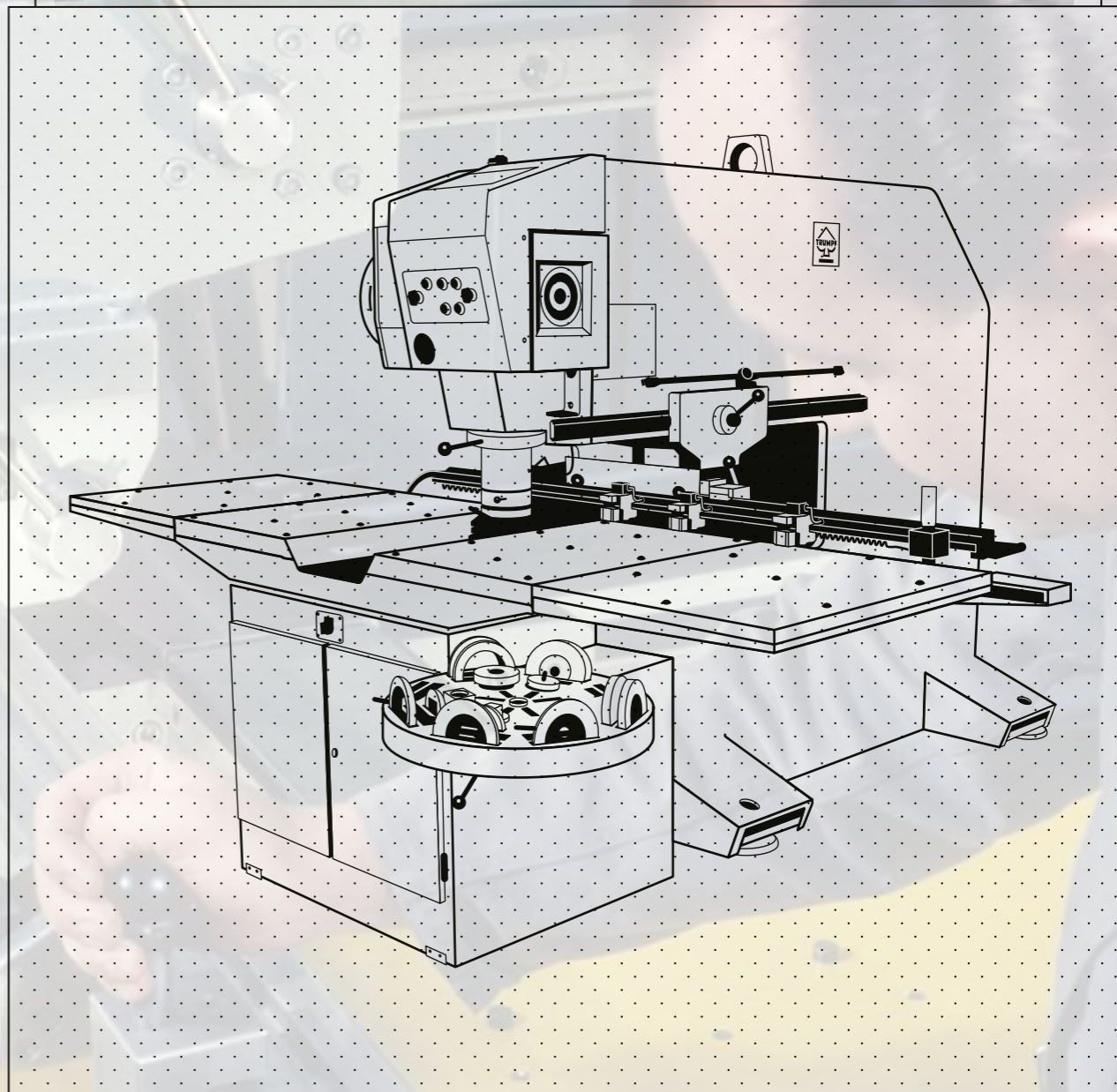

TRUMATIC 20

The TRUMATIC 20 is the first sheet metal processing machine with numerical path control. For the first time, it enables a fully automatic workflow apart from the tool change. All the information required to process the workpiece is stored on punched tape. The machine offers continuous path control for contouring operations and faster programming, and works at a rate of up to 140 strokes per minute. Highlights of models since the 1970s include fully automatic tool change in less than eight seconds; memory for 20 cassettes, each containing a complete tool set consisting of punch, die and stripper; loading and unloading of new tool sets in a few seconds.

5,700 kg Weight
235 cm Height
10 mm Sheet thickness

TECHNOLOGY HIGHLIGHT



Off vibes

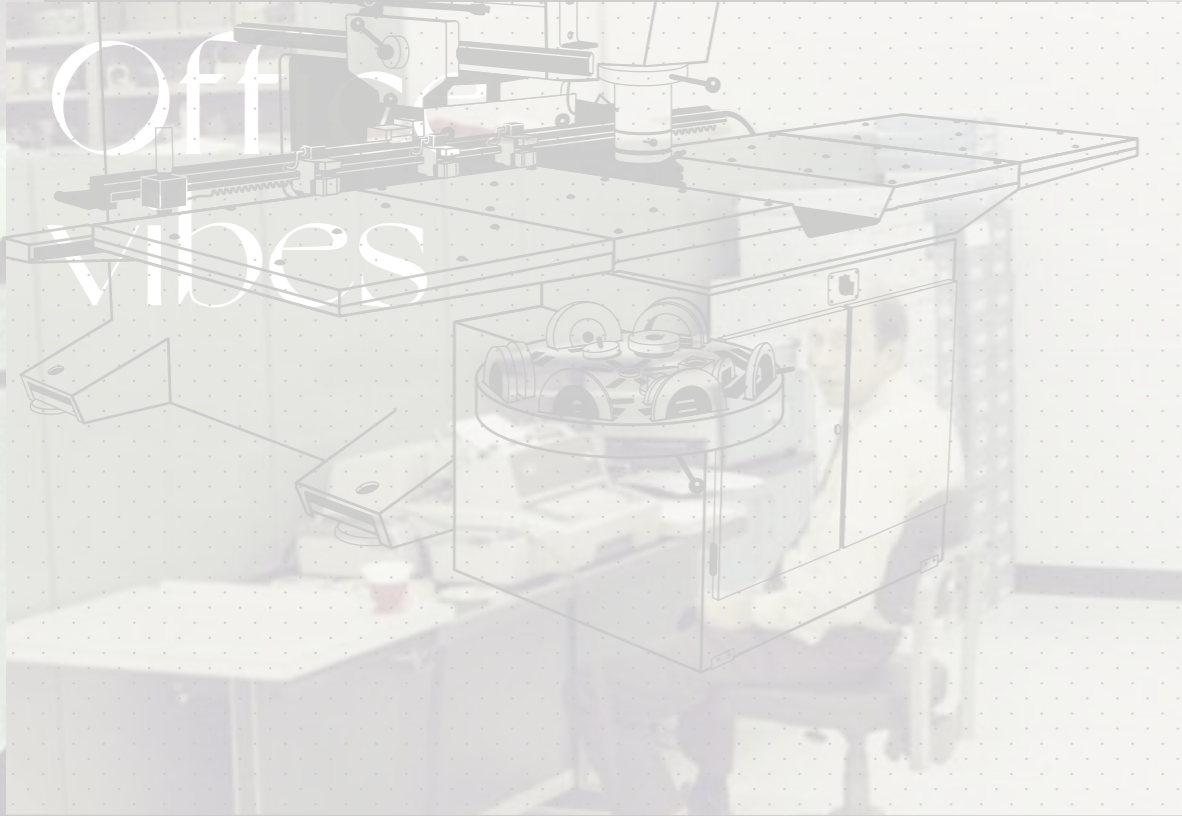

TRUMATIC 50

The TRUMATIC 50 is the first sheet metal processing machine with numerical path control. For the first time it enables a fully automatic working apart from the tool change. All the information required to process the workpiece is stored on punched tape.

5700 kg

Weight

337 cm

Height

EVERYDAY LIFE IN THE OFFICE

Highlights of models since the 1970s include fully automatic tool change in less than eight seconds; memory for 50 cassette tapes; and a 300 mm punch diameter for 50 mm punch holes. In 1972, the company's first fully automatic sheet metal processing machine was introduced in Ditzingen. Below: An employee familiarizing himself with the new office technology in the new Ditzingen building in 1972.

FIRST STEPS IN AUTOMATION

TRUMPF veteran "Bobby" Braun from Ditzingen traces a contour with a copy stamp on a copy nibbling machine. Its transfer produces the newly manufactured workpiece.





Factory cult



WORK THAT CARRIES WEIGHT

Employee Karl Steiner assembles a punching head for the TC 180, one of the first CNC-controlled machines, in Hettingen in 1976. In the foreground, nibbling heads for the CN 701/901 can be seen in red primer.

TRUMATIC LASERPRESS

LIGHT FOR MANUFACTURING

In 1979, TRUMPF moves into laser technology with the Trumatic 180 Laserpress. It is the first combination punch-laser machine. Initially, 500 and 700 Watt CO₂ lasers purchased from the US are used as beam sources.

ERA OF THE INDUSTRIAL LASER

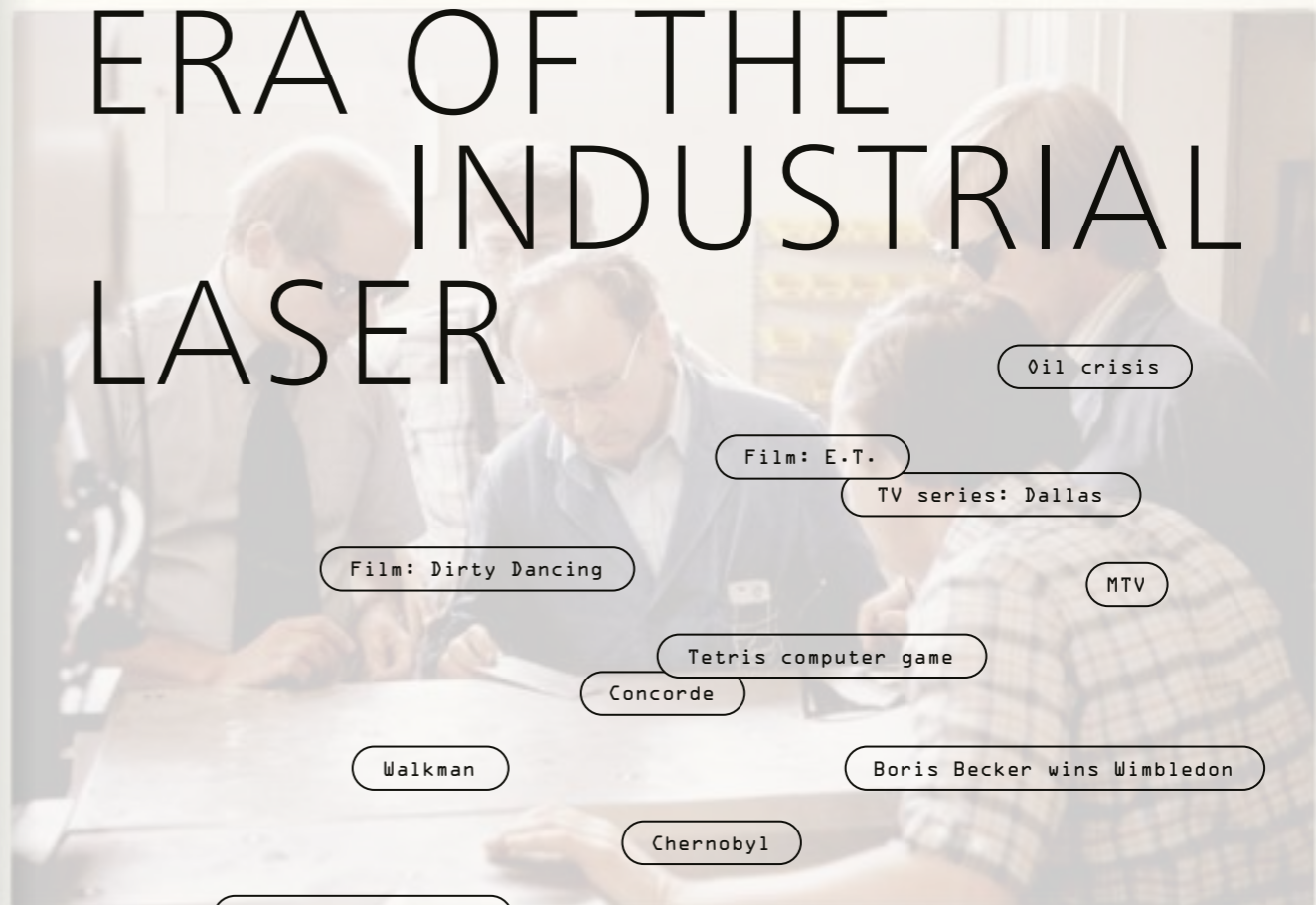

Oil crisis

Film: E.T.

TV series: Dallas

Film: Dirty Dancing

MTV

Tetris computer game

Concorde

Walkman

Boris Becker wins Wimbledon

Chernobyl

Macintosh computer

GPS

Space Shuttle Challenger disaster

Steffi Graf world number one

CD

Pink Floyd "The Wall"

Death of John Lennon

Dies war der allererste Laserschnitt
Herr Braun ihn sofort kritisch prüft.
Voll Neugier schaut er zu, wie
die neue Technik ist. Nicht schlecht.
Wir schneiden jetzt das Laserstrahl
kreuz und quer durch jedes Stahl.

This was our very first cut with a laser
Mr. Braun, the careful punch laser operator
Full of curiosity the team gathered around
The new technique appears to be sound
Any kind of steel or seam
Can now be cut by laser beam

1978-1988

8.8.1979

ERA OF THE INDUSTRIAL LASER

Off crisis

Film: E.T.

TV series: Dallas

MTV

Film: ...

... ..

... ..

... ..

Chernobyl

Macintosh computer

... Shuttle Challenger disaster

CD

Zeffi Graf world number one

Pink Floyd "The Wall"

Death of John Lennon

1978-1988

LIGHT FOR MANUFACTURING
 In 1978 TRUMPF moves into laser technology with the Trumatic L80 Laserpress. It is the first combination punch-laser machine. Initial 500 and 700 Watt CO₂ lasers purchased from the US are used as beam sources.



Dies war der allererste Laserschnitt
 Herr Braun ihn sofort kritisch prüft.
 Voll Neugier schaut das Team aufs Blech,
 die neue Technik ist nicht schlecht.
 Wir schneiden jetzt mit Laserstrahl
 kreuz und quer durch jeden Stahl.

This was our very first cut with a laser
 Mr. Braun, the careful appraiser
 Full of curiosity the team gathers round
 The new technique appears to be sound
 Any kind of steel or seam
 Can now be cut by laser beam.

First cut

8.8.1979

Fascination with lasers



LASER LIGHTS

In 1985 TRUMPF develops its first CO₂ laser in Ditzingen. When it successfully fires up, the developers hug each other with joy.

International- ization



AMERICA BECKONS

Top left: In 1981, the company establishes a subsidiary, TRUMPF Máquinas Ltda., in São Paulo, Brazil. Top right: Berthold, Doris and Peter Leibinger celebrate the start of construction work on the new TRUMPF service and demonstration center in Farmington in 1982 together with the incumbent Democratic Governor of the US state of Connecticut William A. O'Neill (from right). Below: On a delegation trip with Lothar Späth, then Minister President of Baden-Württemberg, Berthold Leibinger shows off the TRUMPF booth in Shenyang in 1981 (from left). They don't miss the opportunity to try out the power tools.

ERA OF THE INDUSTRIAL LASER

Always on the lookout for the next innovation, Berthold Leibinger visits several laser manufacturers during a trip to America. He wants to check whether the CO₂ laser, which is much discussed in trade journals, can be used in sheet metal processing. Upon his return, TRUMPF orders a laser of this type from Photon Sources in Michigan, as the company has a service branch in Germany. Fascinated by the new technology, a development team from Ditzingen begins building the prototype for a punching machine with a 500-watt CO₂ laser in the spring of 1979. The machine can punch out sheet metal parts and cut them with the laser. Later that same year, TRUMPF presents the new TRUMATIC 180 Laserpress to the public at the Exposition Mondiale de la Machine-Outil (EMO) trade show in Milan.

THE FIRST LASER DEVELOPED IN-HOUSE

The quality of the purchased lasers causes TRUMPF great difficulties, however. Time and again, the lasers fail because they often do not meet the requirements for continuous industrial operation. Even a switch to laser manufacturer Coherent does not bring the desired success. In addition, Berthold Leibinger is very concerned about becoming dependent on an American laser manufacturer. In 1982, he therefore decides to work with the German Aerospace Research and Testing Institute (DFVLR) in Stuttgart on the development of his own one-kilowatt CO₂ laser.

The project comes to fruition in 1985, when the first CO₂ laser developed and produced in-house is launched on the market. The TLF 1000 has one kilowatt of beam power and is the first compact laser resonator with high-frequency excitation.

Demand is huge: instead of the 60 planned lasers, TRUMPF produces twice as many in 1987. But even that quickly proves to be too little. Just between 1986 and 1995, TRUMPF sells a total of some 2,500 CO₂ lasers.

COMPUTERS FOR THE WORLD OF WORK

From the 1980s onward, the Commodore 64 home computer and the first game consoles help popularize information technology. Computers don't stop at mechanical engineering either. In machine control, TRUMPF succeeds in taking the next major development step with the transition to computer-controlled CNC machine tools. In 1982, TRUMPF presents the Trumatic 225 with Siemens controls and in 1983 the Trumatic 235 with Bosch controls. Thanks to new microchips, workpieces can now be designed directly on the computer screen and transferred to a production program. A floppy disk stores the design data for the first time. The next innovation follows in 1987: the Trumatic L 3000 flatbed laser cutting machine has flying optics, so from now on, the workpiece no longer moves in the machine during cutting. Instead, the processing head 'flies' over the sheet metal.

The spade logo, formerly developed from a playing card, no longer fits the image of the modern company. After almost 40 years, TRUMPF introduces the blue rectangle as its logo in 1985, which is still in use today. This is also accompanied by a change in the machine color, with white gradually replacing the original green. At this time, this is a novelty in mechanical engineering.

ALWAYS CLOSE TO OUR CUSTOMERS

The introduction of computer-controlled machine tools massively increases the need for training. This applies both to sales staff and customers. In 1985 alone, TRUMPF conducts programming courses for over 1,100 participants. Then there are special training courses for the maintenance and operation of the new laser machines.

In 1987, TRUMPF inaugurates a demonstration center in Ditzingen with a machine presentation area of 5,500 square meters. The aim is for customers to be able to see the innovations and quality of TRUMPF machines for themselves on site.

1978— 1988

ERA OF THE International LASERIZATION

COMPUTERS FOR THE WORLD OF WORK

From the 1980s onward, the Commodore 64 home computer and the first game consoles help popularize information technology. Computers don't stop at mechanical engineering either. In machine control, TRUMPF succeeds in taking the next major development step with the transition to computer-controlled CNC machine tools. In 1982, TRUMPF presents the Trumatic 225 with Siemens controls and in 1983 the Trumatic 235 with Bosch controls. Thanks to new microchips, workpieces can now be designed directly on the computer screen and transferred to a production program. A floppy disk stores the design data for the first time. The next innovation follows in 1987: the Trumatic L 3000 flatbed laser cutting machine has flying optics, so from now on, the workpiece no longer moves in the machine during cutting. Instead, the processing head flies over the sheet metal.

The spade logo, formerly developed from a playing card, no longer fits the image of the modern company. After almost 40 years, TRUMPF introduces the blue rectangle logo in 1985, which is still in use today. This is accompanied by a change in the machine color scheme, gradually replacing the original green. At this time, this is a novelty in mechanical engineering.

ALWAYS CLOSE TO OUR CUSTOMERS

The introduction of computer-controlled machine tools massively increases the need for training. TRUMPF both to sales staff and customers. In 1985 alone, TRUMPF conducts programming courses for over 1,000 participants. Then there are special training courses for maintenance and operation of the new laser machines. In 1987, TRUMPF inaugurates a demonstration center in Ditzingen with a machine presentation area of 1,000 square meters. The aim is for customers to be able to see the innovations and quality of TRUMPF technology themselves on site.

Always on the lookout for the next innovation, Berthold Leibinger visits several laser manufacturers during a trip to America. He wants to check whether the CO₂ laser, which is much discussed in trade journals, can be used in sheet metal processing. Upon his return, TRUMPF orders a laser of this type from Photon Sources in Michigan, as the company has a service branch in Germany, associated by the new technology, a development team from Ditzingen begins building the prototype for a punching machine with a 500-watt CO₂ laser in the spring of 1979. The machine can punch out sheet metal parts and cut them with the laser. Later that same year, TRUMPF presents the new TRUMATIC 180 Lasers to the public at the Exposition Mondiale de la Machine-Outil (EMO) trade show in Milan.

THE FIRST LASER DEVELOPED IN-HOUSE

The quality of the purchased lasers causes TRUMPF great difficulties, however. Time and again, the lasers fail during industrial operation. Even a switch to laser manufacturer Coherent does not bring the desired success. In addition, Berthold Leibinger is very concerned about becoming dependent on an American laser manufacturer. In 1982, he therefore decides to work with the German Aerospace Research and Testing Institute (DFVLR) in Stuttgart on the development of his own one-kilowatt CO₂ laser.

The project comes to fruition in 1985, when the first CO₂ laser developed and produced in-house is launched on the market. The TCF 1000 has one kilowatt of beam power and is the first compact laser resonator with high-frequency excitation.

Demand huge: instead of the 60 planned lasers, TRUMPF produces twice as many in 1987. But even that quickly proves to be too little. Just between 1986 and 1992, TRUMPF sells a total of some 2,500 CO₂ lasers.

1989 Essen



AMERICA ELKONS

Top left: In 1981, the company establishes a subsidiary, TRUMPF Máquinas LTDA, in São Paulo, Brazil. Top right: Berthold, Doris and Peter Leibinger celebrate the start of construction work on the new TRUMPF service and demonstration center in Farmington in 1985 together with the incumbent Democratic Governor of the US state of Connecticut William A. O'Neill (from right). Below: On a delegation trip with Lothar Späth, then Minister President of Baden-Württemberg, Berthold Leibinger shows off the TRUMPF booth in Shenyang in 1984 (from left). They don't miss the opportunity to try out the power tools.





WORKMANSHIP

Andreas Böppe 1987 in Ditzingen in final assembly at a 3D laser-only machine teaching in a 3D part. Below: In the same year, TRUMPF opens its demonstration center in Ditzingen. Berthold Leibinger (left) presents the Trumatic 240 punching machine to Minister President of Baden-Württemberg Lothar Späth. A TLF 5000 laser is in the background.

TECHNOLOGY HIGHLIGHT



TRUMPF TLF LASER

The first CO₂ laser developed in-house by TRUMPF, the TLF (TRUMPF Laser Fast Flow) is available in two different power levels: the TLF 1000 (1 kilowatt) and TLF 1500 (1.5 kilowatts). It is the first compact laser resonator with high-frequency excitation.

The laser's wavelength makes it possible to process different types and thicknesses of materials. Manufacturing with the laser is stable, productive and generates little spatter. Its compact design means that existing systems can be easily retrofitted with the CO₂ laser.

500 kg
Weight

135 cm
Height

50 W – 1,500 W
Power

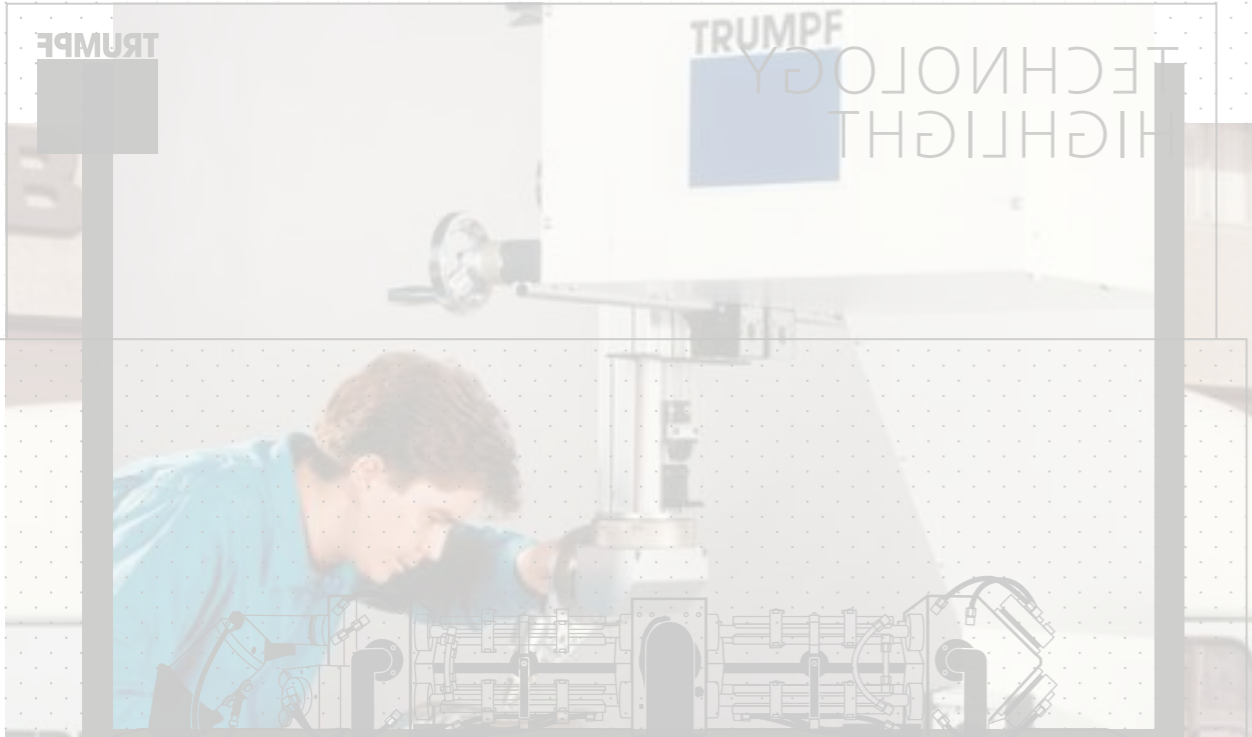

WORKMANSHIP

The laser's wavelength makes it possible to process different types and thicknesses of materials. The laser is used for cutting, engraving and welding. The TRUMPF TLF 1008 (2 kilowatts) and TLF 1508 (3 kilowatts) are available in two different power levels. The TRUMPF TLF 1008 (2 kilowatts) and TLF 1508 (3 kilowatts) are available in two different power levels. The TRUMPF TLF 1008 (2 kilowatts) and TLF 1508 (3 kilowatts) are available in two different power levels.

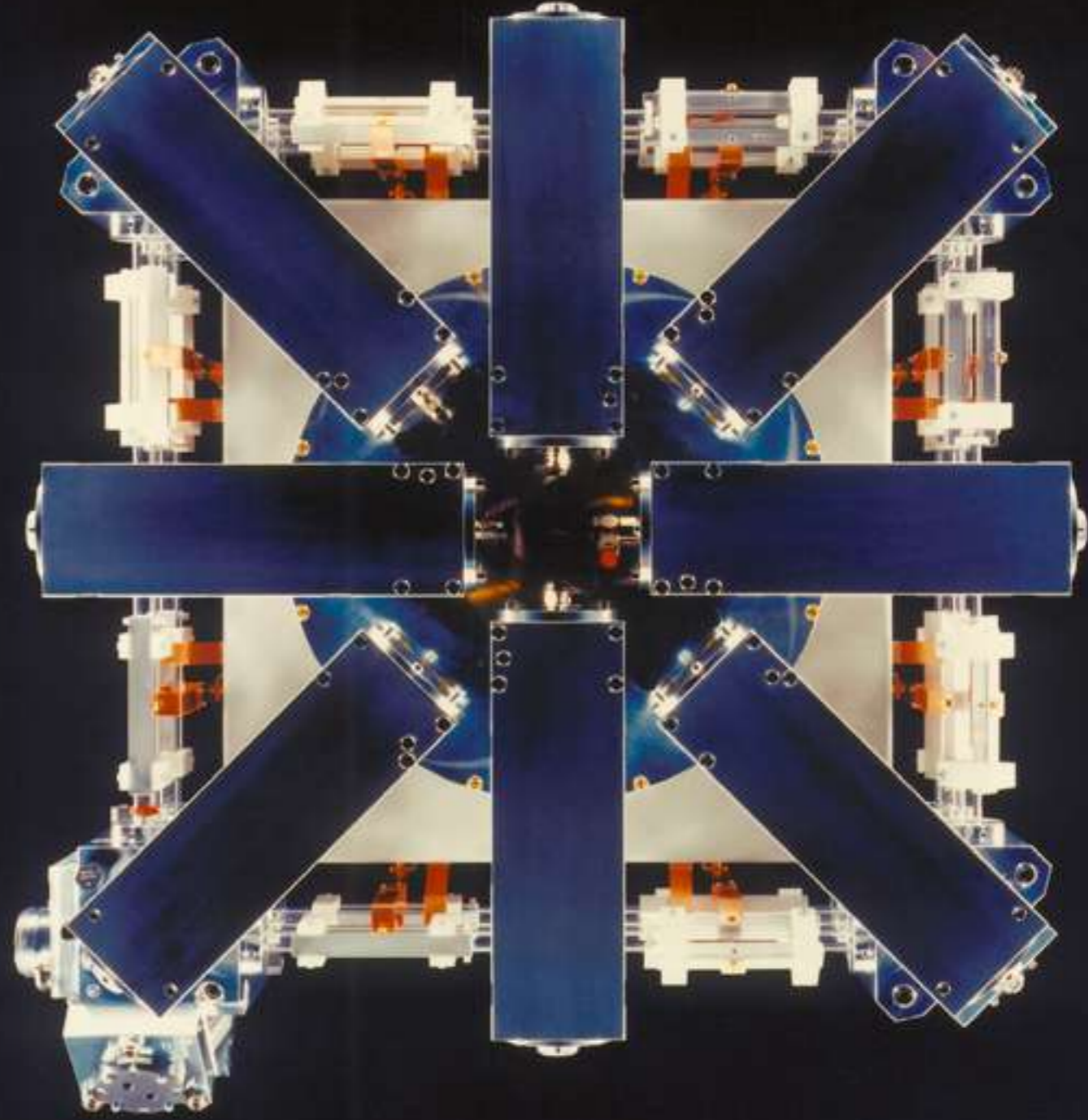

COMPACT ALL-ROUNDER
 In 1987, TRUMPF develops a square, 'folded' CO₂ laser. It is compact and has high beam quality. In this combination, it is a novelty.

FALL OF THE BERLIN WALL AND REUNIFICATION



Neukirch

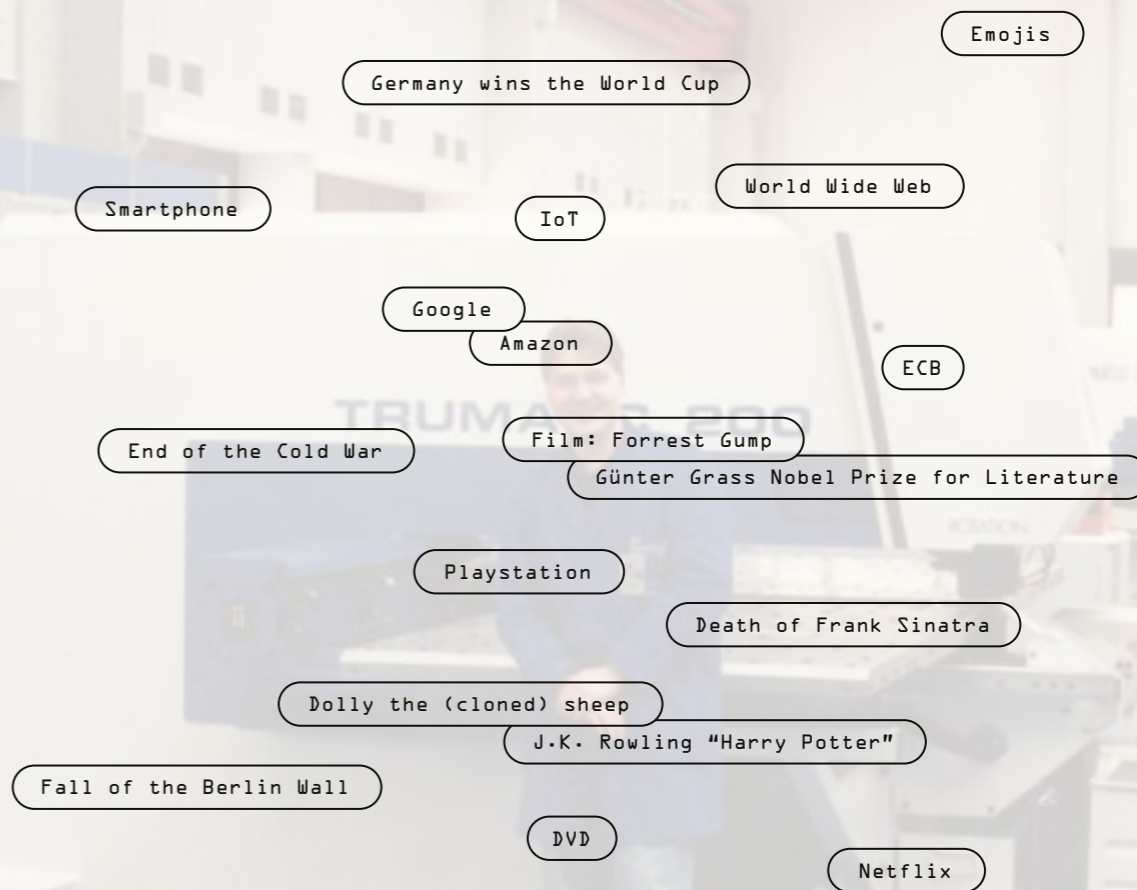

1989-1999

SUCCESSFUL CUSTOMER PRESENTATION
 Long-time employee Bernd Thalmann in 1995 in front of a Trumatic 200 after a successful customer presentation at the demonstration center in Ditzingen.

FALL OF THE BERLIN WALL AND REUNIFICATION



1980s

Neukirch



SUCCESSFUL CUSTOMER PRESENTATION

Long-time employee Bernd Thalmann in 1975 in front of a Trumatic 200 after a successful customer presentation at the demonstration center in Ditzingen.



In the
factory

SCREWING WORK IN DITZINGEN
Assembly of a 3D laser cutting
machine with cantilever.

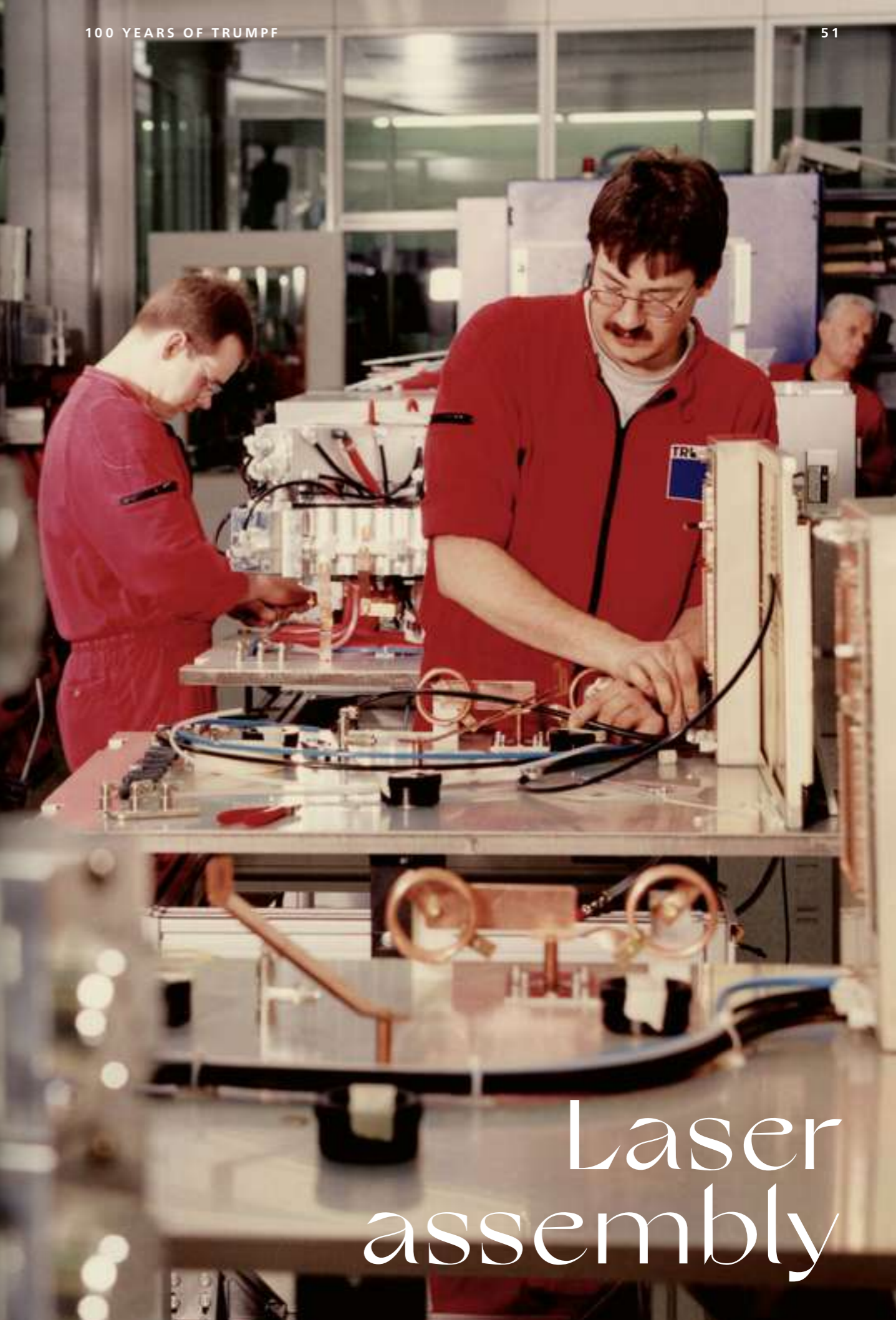

MORE LASER

The Trumatic 260 Laserpress is one of the first machines in the Ditzingen demonstration center to feature a laser built in-house. Below: In 1998, TRUMPF opens a new laser factory in Ditzingen, where the company assembles, among other things, the TLF 1500 Turbo with new square 'folded' CO₂ lasers. With a lateral length of only 80 cm, the laser housing accommodates a resonator length totaling three meters.

Laser assembly

Significant encounters



BETWEEN TWO WORLDS

At the Leipzig Spring Fair in March 1989, Erich Honecker visits the TRUMPF booth. Back then, the GDR leadership was planning to purchase laser units from TRUMPF and install them in machine tools made by Sächsische Werkzeug und Sondermaschinen GmbH (SWS) in Neukirch. In response to Honecker's question about what a laser is, Leibinger replies "The laser is a tool that you can use to separate or join things - it just depends on the setting." Honecker swallows this remark without comment.

FALL OF THE BERLIN WALL AND REUNIFICATION

The reforms of Soviet President Mikhail Gorbachev, the economic crisis in the GDR, the mass exodus of people to the West and the ever-growing Monday demonstrations in Leipzig lead to an unexpected miracle in the fall of 1989: the fall of the Berlin Wall on November 9 and the peaceful reunification of Germany on October 3, 1990.

INVESTMENTS IN THE NEW FEDERAL STATES

Sächsische Werkzeug und Sondermaschinen GmbH (SWS) in Neukirch was already equipping its laser cutting machines with lasers from TRUMPF in the GDR era. In 1991, under the administration of Treuhandanstalt Berlin, the production of loading devices for TRUMPF machines begins. After enjoying a good working relationship for many years, the company becomes a subsidiary of the TRUMPF Group in 1992. Subsequently, plans are made for the factory in Neukirch to switch its production from laser cutting machines to new types of waterjet cutting machines. TRUMPF presents the first Trumatic WS 2500 at the EuroBLECH trade show in Hannover in 1992. However, the machine does not sell in large numbers, even after years of effort. In 2003, the painful decision is made in Ditzingen to end the foray into waterjet cutting.

CONQUERING NEW AREAS

Diversification defines the 1990s at TRUMPF. With its move into laser production, TRUMPF needs a reliable partner for the manufacture of high-frequency generators. HÜTTINGER in Freiburg develops into an important supplier in the following years. When in 1990 the company succession remains unresolved, TRUMPF takes over the majority stake.

In the same year, TRUMPF decides to move into bending technology for sheet metal parts so that it can cover all production steps from cutting flat parts to the finished product. The new factory in Pasching, Austria, henceforth builds the TrumaBend V5 and remains TRUMPF's lead factory for bending machines to this day.

TRUMPF's participation in HAAS Laser in Schramberg in 1991 opens the door to the world of solid-state lasers. In the same year, TRUMPF begins operations in Singapore as a hub for the Asia/Pacific region.

In 1992, the Berthold Leibinger Stiftung is established with the goal of advancing innovative science, creating a rich cultural landscape and strengthening social commitment in society.

CRISIS IN MECHANICAL ENGINEERING

The global economic crisis of the 1990s is also felt in the German mechanical engineering sector. When the decline in orders at TRUMPF worsens dramatically in 1993, Berthold Leibinger sees his life's work in danger. In 1994, the Baden-Württembergische Beteiligungsgesellschaft (BWK) temporarily steps in to save the company. Unlike many other companies in the sector, TRUMPF emerges from the crisis stronger than before: laser technology has developed as a strong second pillar alongside classic mechanical engineering, and the foreign production locations established early on are profitable.

INTRODUCTION OF SYNCHRO FLOW PRODUCTION

With the major crisis in mechanical engineering, the time has come at TRUMPF for a self-critical appraisal. Japanese mechanical engineers have an enormous cost advantage over their German competitors: Efficient organization and flow production enable them to produce much more cheaply.

Because of the small quantities, significant weight, and size of the machine tools, some people at TRUMPF in Ditzingen are initially skeptical about the production lines. After an event organized by Japanese management consultant Hitoshi Takeda, managing director Mathias Kammüller is able to persuade those concerned to rethink.

With the introduction of flow assembly at the end of the 1990s, the production time of a machine compared to stationary assembly is reduced from an average of 56 to 21 days. Given such impressive figures, the Ditzingen factory receives the "Factory of the Year" award from PRODUKTION magazine in 2002.

For many
visions 1989–
Berthold Leibinger 1999

FALL OF THE BERLIN WALL AND REUNIFICATION

In 1992, the Berthold Leibinger Stiftung is established with the goal of advancing innovative science, creating a rich cultural landscape and strengthening social commitment in society.

CRISIS IN MECHANICAL ENGINEERING

The global economic crisis of the 1990s is also felt in the German mechanical engineering sector. When the decline in orders at TRUMPF worsens dramatically in 1993, Berthold Leibinger sees his life's work in danger. In 1994, the Baden-Württembergische Beteiligungsgesellschaft (BWK) temporarily steps in to save the company. Unlike many other companies in the sector, TRUMPF emerges from the crisis stronger than before. Laser technology has developed as a strong second pillar alongside classic mechanical engineering, and the foreign production locations established early on are profitable.

INTRODUCTION OF SYNCHRO FLOW PRODUCTION

With the major crisis in mechanical engineering, the time has come at TRUMPF for a self-critical appraisal. Japanese mechanical engineers have an enormous cost advantage over their German competitors. Efficient organization and flow production enable them to produce much more cheaply.

Because of the small quantities, significant weight, and size of the machine tools, some people at TRUMPF in Ditzingen are initially skeptical about the production lines. After an event organized by Japanese management consultant Hitoshi Takeda, managing director Matthias Kammler is able to persuade those concerned to rethink.

With the introduction of flow assembly at the end of the 1990s, the production time of a machine compared to stationary assembly is reduced from an average of 25 to 21 days. Given such impressive figures, the Ditzingen factory receives the "Factory of the Year" award from PRODUKTION magazine in 2002.

BETWEEN TWO WORLDS

At the Leipzig Spring Fair in March 1989, Erich Honecker visits the TRUMPF booth. Back then, the GDR leadership was planning to purchase laser units from TRUMPF and install them in machine tools made by Sächsische Werkzeug und Sondermaschinen GmbH (SWZ) in Neukirch. In response to Honecker's question about what a laser is, Leibinger replies "The laser is a tool that you can use to separate or join things, it just depends on the setting." Honecker swallows this remark without comment.

The reforms of Soviet President Mikhail Gorbachev, the economic crisis in the GDR, the mass exodus of people to the West and the ever-growing Monday demonstrations in Leipzig lead to an unexpected miracle in the fall of 1989: the fall of the Berlin Wall on November 9 and the peaceful reunification of Germany on October 3, 1990.

INVESTMENTS IN THE NEW FEDERAL STATES

Sächsische Werkzeug und Sondermaschinen GmbH (SWZ) in Neukirch was already equipping its laser cutting machines with lasers from TRUMPF in the GDR era. In 1991, under the administration of Teufelbachanstalt Berlin, the production of loading devices for TRUMPF machines begins. After enjoying a good working relationship for many years, the company becomes a subsidiary of the TRUMPF Group in 1992. Subsequently, plans are made for the factory in Neukirch to switch its production from laser cutting machines to new types of waterjet cutting machines. TRUMPF presents the first Trumatic WS 2500 at the EuroBLECH trade show in Hannover in 1992. However, the machine does not sell in large numbers, even after years of effort. In 2003, the painful decision is made in Ditzingen to end the foray into waterjet cutting.

CONQUERING NEW AREAS

Diversification defines the 1990s at TRUMPF. With its move into laser production, TRUMPF needs a reliable partner for the manufacture of high-frequency generators. HÜTTINGER in Freiburg develops into an important supplier in the following years. When in 1990 the company succession remains unresolved, TRUMPF takes over the majority stake.

In the same year, TRUMPF decides to move into bending technology for sheet metal parts so that it can cover all production steps from cutting flat parts to the finished product. The new factory in Pasching, Austria, henceforth builds the TruBend V2 and remains TRUMPF's lead factory for bending machines to this day.

TRUMPF's participation in HAAS Laser in Schramberg in 1997 opens the door to the world of solid-state lasers. In the same year, TRUMPF begins operations in Singapore as a hub for the Asia-Pacific region.

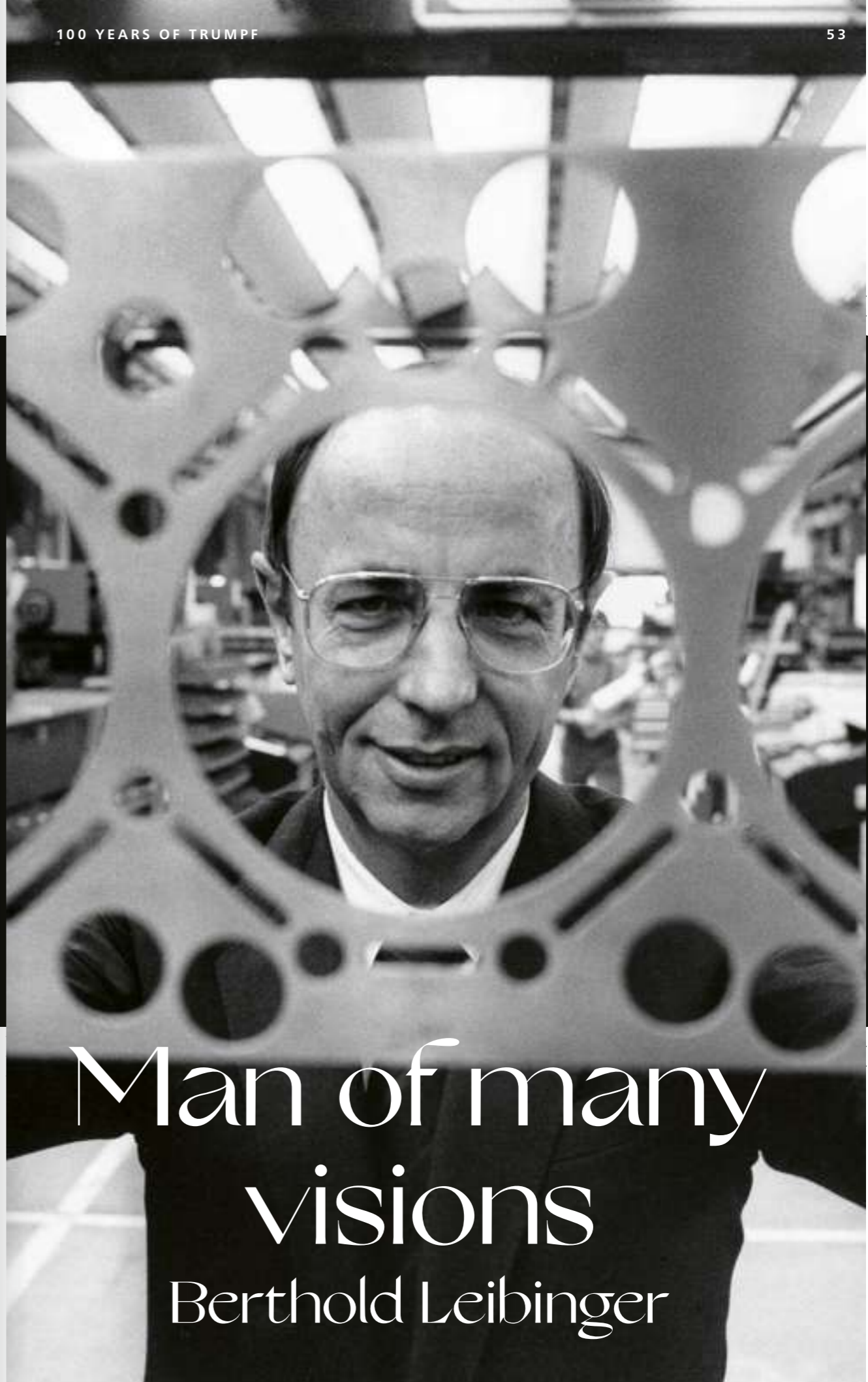

Man of many visions

Berthold Leibinger



PUNCH IN WHITE

In Ditzingen, TRUMPF assembles the Trumatic 260 R with new hydraulic punching head in a new white color concept. The rotation of the tool holder allows all tools to be turned.

Factory & employees



TEAMS AT WORK

Above: Employees also enjoy their work in the mailroom and cafeteria. Below: Technical trainees test learning islands and repair power tools with Joachim Bürklen for their assignment in the factory. During their training, Marco Grund and Thomas König put a handling device into operation.



Development & trials



DEVELOPMENT AND TRIALS IN SCHRAMBERG

Hamdi Uyan and Gerd Haller (from left to right) use a logic analyzer and oscilloscope to try to get to the bottom of a software error. Below: Ralf Denkinger adjusts a coupling on an HL4006D laser in Schramberg.

TECHNOLOGY HIGHLIGHT

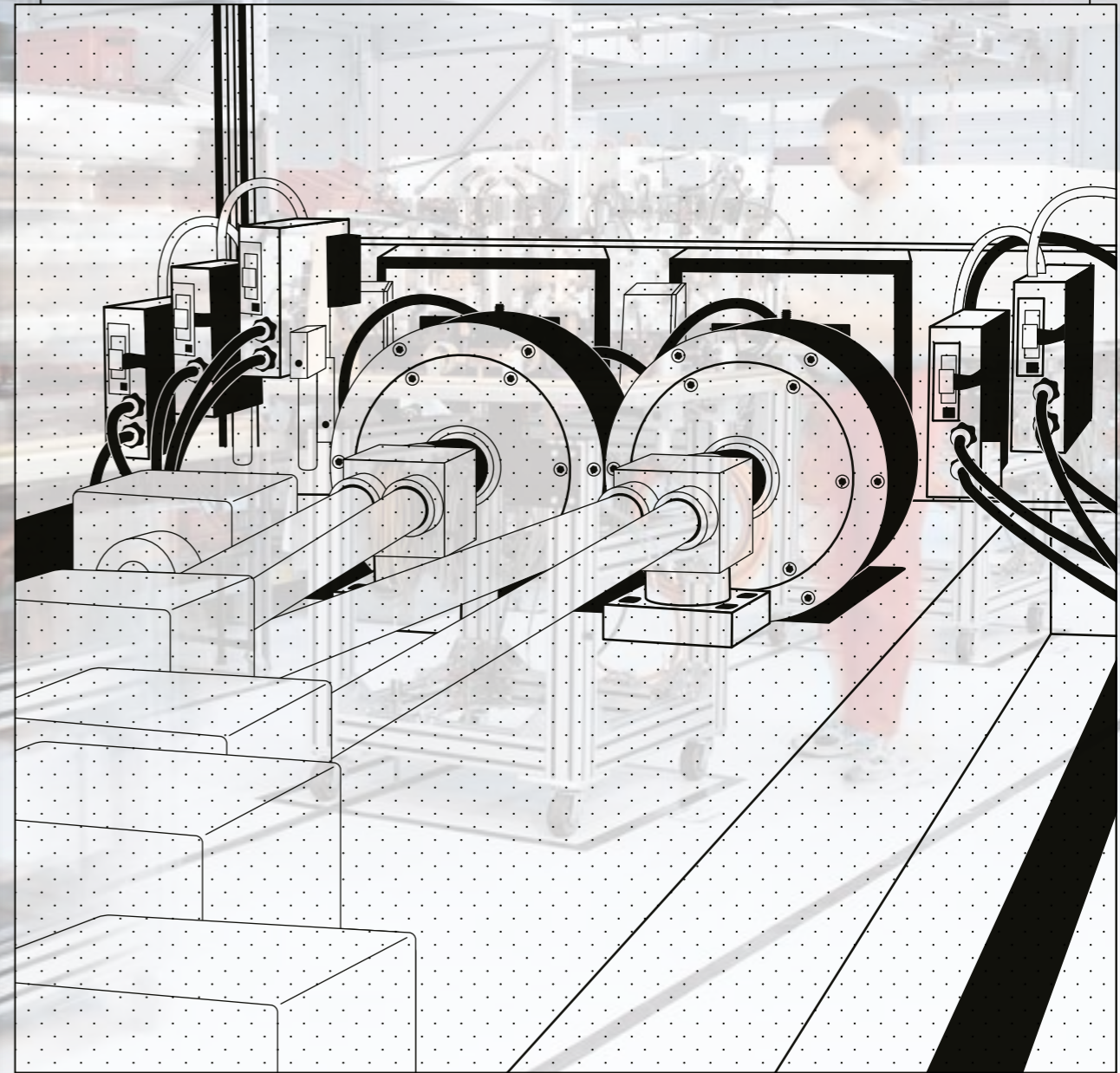

TRUDISK 1000 DISK LASER

From drilling ultra-fine holes the diameter of a hair to welding ship panels, from CW lasers to ultrashort pulse lasers, disk laser technology comes into its own both at high pulse energies and at high average powers. The high-power laser is suited to many applications in the automotive industry, such as powertrain applications, where the requirements for accuracy and reproducibility of the welding results are particularly demanding. The disk laser cuts a wide range of sheet thicknesses and material types up to and including highly reflective non-ferrous metals.

490 kg Weight
143 cm Height
60 W – 1,000 W Power

TRUMPF

TECHNOLOGY
HIGHLIGHT

Development & trials

TRUMPF 1000 DISK LASER
 From drilling ultra-fine holes the diameter of a hair to welding ship panels, from CW lasers to ultrashort pulse lasers, the TRUMPF 1000 Disk Laser is a high-precision laser with a wide range of applications. The high-power laser is suited to many applications in the automotive industry, such as powertrain components, where the requirements for accuracy and reproducibility of the welding results are particularly high. In the TRUMPF 1000 Disk Laser, the high-power laser is suited to many applications in the automotive industry, such as powertrain components, where the requirements for accuracy and reproducibility of the welding results are particularly high.

Weight 430 kg
 Height 143 cm

DEVELOPMENT AND TRIALS IN SCHRAMBERG
 Hamdi Uyan, Gerd Hainke, and Gerd Hainke are working on a TRUMPF 1000 Disk Laser in Schramberg. They are using an oscilloscope to try to find the best settings for the laser. Denkinger adjusts a coupling on an HL4000D laser in Schramberg.



Assembly flow



Ditzingen

SALES AND SERVICE CENTER

MILLENNIUM PERIOD

COMPANY RESTAURANT, DITZINGEN

A new center on the campus is created in 2008 with the "Blautopf". The spacious interior in the new building type in Ditzingen serves as a restaurant, exhibition space and auditorium for events.

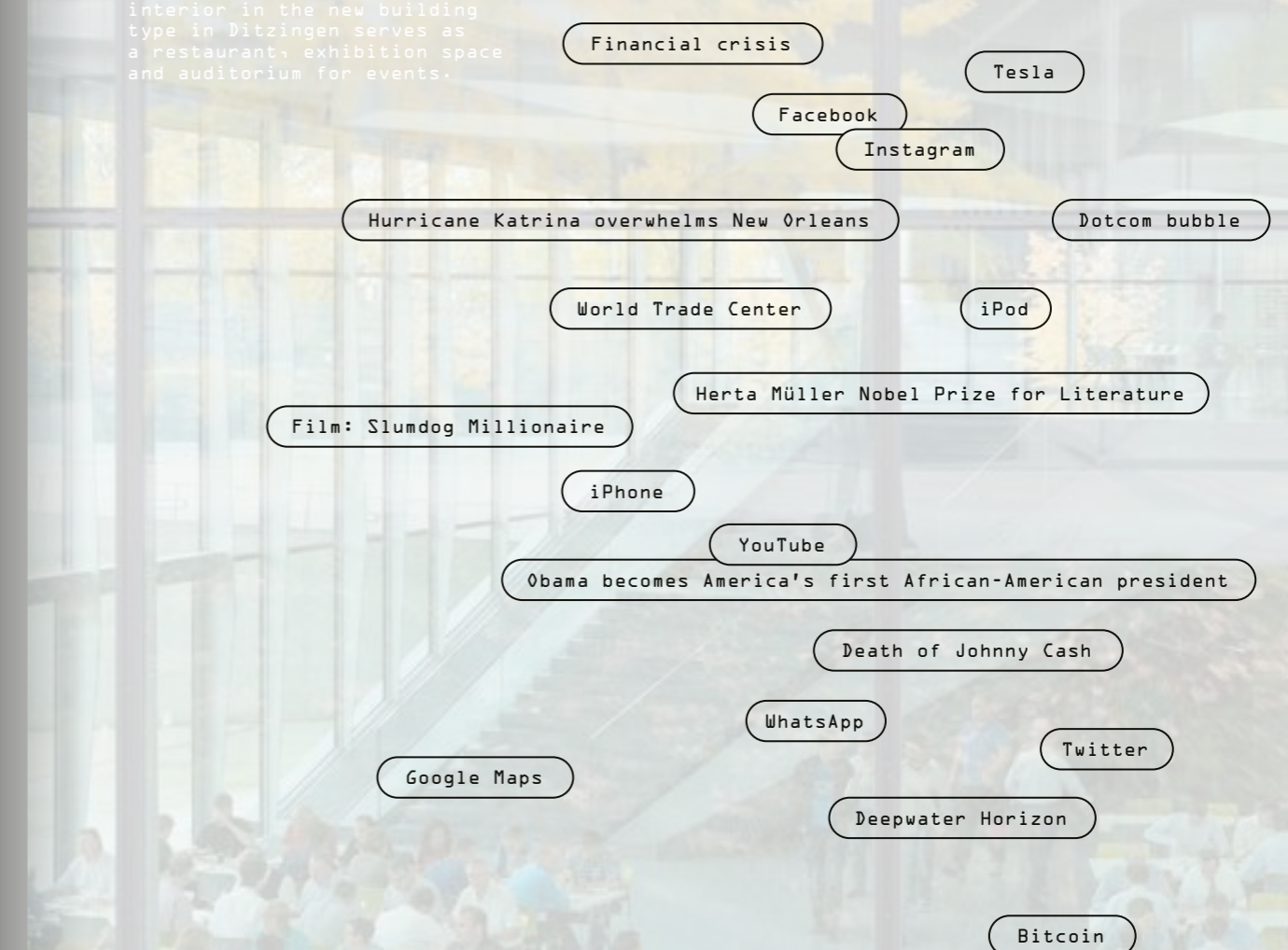

2000 — 2010

MILLENNIUM PERIOD

Financial crisis

Tesla

Facebook

Instagram

Dotcom bubble

Hurricane Katrina overwhelms New Orleans

World Trade Center

iPhone

Hertha Müller Nobel Prize for Literature

Film: Slumdog Millionaire

YouTube

Obama becomes America's first African-American president

Death of Johnny Cash

WhatsApp

Twitter

Google Maps

Deppster Harrison

Bitcoin

2000-2010 Ditzingen

SALES AND SERVICE CENTER

“Blautopf”

COMPANY RESTAURANT, DITZINGEN

A new center on the campus is created in 2008 with the “Blautopf”. The spacious interior in the new building type in Ditzingen serves as a restaurant, exhibition space and auditorium for events.





Hettingen

MORE TRAINING

Situated in the picturesque Lauchert valley, surrounded by dense forest and rugged rocky outcrops: in 2009, TRUMPF adds an office building with training workshops to the existing factory.



START-UP CENTER, GRÜSCH

In Grüşch in the Swiss canton of Graubünden, the start-up center opened in 2001 as a free-standing pavilion with workshops, offices, conference rooms and a canteen. Below: On a two-hectare site on the outskirts of Schramberg, TRUMPF expands the footprint of its existing commercial facility in 2000. New offices, laboratories, classrooms and a café are built for the 1980s laser factory.

Neukirch



New beginnings



READY FOR NEW CHALLENGES

Above: (from left to right) Peter Leibinger, Nicola Leibinger-Kammüller and Mathias Kammüller in 2005 upon taking over the management of the company. At the turn of the millennium, a new customer center is built in Farmington. At the groundbreaking ceremony, Berthold Leibinger (3rd from left) and his son-in-law Mathias Kammüller (2nd from right) stand out in their light-colored trench coats. Below: The Ditzingen campus expands to include the training center, the sales and service center and a laser factory. Mathias Kammüller and Nicola Leibinger-Kammüller visiting the subsidiary in Japan in 2007.

MILLENNIUM PERIOD

CLEAR EDGE
Subtech trade show in
Silsheim in 2002. Employees
stand by a bending machine.

The new millennium begins with a record for TRUMPF, as sales revenues exceed 1 billion euros for the first time. Not everyone is in such a good financial position, however, and the dotcom bubble of the new economy leaves its mark on small investors in broad sections of society.

MOVE INTO THE MONEY BUSINESS

Regardless of the squabbles on the international markets, Berthold Leibinger considers entering the financial sector.

During his time on the supervisory board of BMW, he comes up with the brilliant idea of transferring the concept of leasing new cars to the machine tool market.

For many medium-sized customers, the purchase of a machine tool is a major financial undertaking. With the founding of TRUMPF Leasing + Service GmbH + Co. KG in 2001, they can now take out leases.

GENERATION CHANGE

After more than 40 years in management, Berthold Leibinger hands over the reins of the company to the next generation of the family in 2005 and takes on the chairmanship of the Supervisory Board. His daughter Nicola Leibinger-Kammüller takes over as Chief Executive Officer, son Peter Leibinger is responsible for Laser Technology and Vice CEO, and son-in-law Mathias Kammüller is responsible for the Machine Tools division. The management team now faces up to new challenges together. Particular attention is paid to the company's expanded focus on the Chinese market.

TRUMPF PRODUCES GLOBALLY

The rapid rise of China as an industrial nation makes it essential for TRUMPF to establish a production facility there.

In 2007, the company establishes TRUMPF Machine Tools Co. Ltd. in Taicang, 50 kilometers north of Shanghai. Its initial task is to sell TRUMPF machine tools in China. TRUMPF continues to produce high-tech products such as lasers, control elements and motion units outside of China and to import them.

Although TRUMPF has been selling products in Japan since the 1950s, it is not until 2008 that the company opens its first production company in Fukushima. Before that, production activities are limited for a long time to the installation of supplied computer controls in the company's own machine tools and the final assembly of parts supplied from Germany. The task of the TRUMPF Manufacturing Corporation is to manufacture storage systems and automation equipment for machine tools.

MECHANICAL ENGINEERING IN THE GLOBAL FINANCIAL CRISIS

On September 15, 2008, the Lehman Brothers investment bank files for bankruptcy. Events on the world's financial markets then come to a head. The bursting of the real estate bubble in the US is seen as the trigger. But the financial crisis is not the end of the story. Consumption falls sharply worldwide, causing industrial production to slump massively. The major industrialized countries slide into the biggest recession since the Second World War, with the export-oriented German economy hit particularly hard. In November 2008, TRUMPF faces an unexpected slump in its orders. Unlike during the crisis in the 1990s, the company's management reacts immediately and cuts production. Sales revenues drop by 22.5 percent in fiscal year 2008/09. To avoid compulsory redundancies, the company introduces short-time working at its German locations, but it quickly becomes clear that these measures are not enough on their own. As a precautionary measure, the owner family decides to increase the equity ratio through private contributions.

Despite the slump in sales, the company looks to the future: TRUMPF acquires British fiber laser manufacturer SPI Lasers and further increases R&D spending – making it well prepared when demand picks up again significantly in mid-March 2010. In the following fiscal year, 2010/11, the company records the largest growth in revenues in its history. Sales revenues increase by 51 percent to 2.02 billion euros.

2000— 2010

MILLENNIUM WORK PERIOD beginnings

Although TRUMPF has been selling products in Japan since the 1970s, it is not until 2008 that the company opens its first production company in Fukushima. Before that, production activities are limited for a long time to the installation of supplied computer controls in the company's own machine tools and the final assembly of parts supplied from Germany. The task of the TRUMPF Manufacturing Corporation is to manufacture storage systems and automatic equipment for machine tools.

MECHANICAL ENGINEERING IN THE GLOBAL FINANCIAL CRISIS

On September 15, 2008, the Lehman Brothers investment bank collapses for bankruptcy. Events on the world financial market then come to a head. The bursting of the real estate bubble in the US is seen as the trigger for the financial crisis. It is not the end of the story. Continued global financial crisis causes industrial production to decline worldwide. The major industrialized nations face their worst recession since the Second World War, with the export-oriented German economy hit particularly hard. In November 2008, TRUMPF faces an unexpected slump in its orders. Unlike during the crisis in the 1990s, the company's management reacts immediately and cuts production. Sales revenues drop by 22.5 percent in fiscal year 2008/09. To avoid compulsory redundancies, the company introduces short-time working at its German locations, but it quickly becomes clear that these measures are not enough on their own. As a precautionary measure, the owner family decides to increase the equity ratio through private contributions.

Despite the slump in sales, the company looks to the future: TRUMPF acquires British fiber laser manufacturer PL Lasers and further increases R&D spending — making it well prepared when demand picks up again significantly in mid-March 2010. In the following fiscal year 2010/11, the company records the largest growth in revenue in its history. Sales revenue increases by 21 percent

The new millennium begins with a record for TRUMPF. Sales revenues exceed 1 billion euros for the first time. Not everyone is in such a good financial position, however, and the bottom bubble of the new economy leaves its mark on small investors in broad sections of society.

MOVE INTO THE MONEY BUSINESS

Regardless of the squabbles on the international markets, Berthold Leibinger considers entering the financial sector. During his time on the supervisory board of BMW, he comes up with the brilliant idea of transferring the concept of leasing new cars to the machine tool market. For many medium-sized customers, the purchase of a machine tool is a major financial undertaking. With the founding of TRUMPF Leasing + Service GmbH + Co. KG in 2001, they can now take out leases.

GENERATION CHANGE

After more than 40 years in management, Berthold Leibinger hands over the reins of the company to the next generation of the family in 2005 and takes on the chairmanship of the supervisory board. His daughter Nicola Leibinger-Kammüller takes over as Chief Executive Officer. Peter Leibinger is responsible for Laser Technology and Vice CEO, and son-in-law Mathias Kammüller is responsible for the Machine Tools division. The management team now faces up to new challenges together. Particular attention is paid to the company's expanded focus on the Chinese market.

TRUMPF PRODUCES GLOBALLY

The rapid rise of China as an industrial nation makes it essential for TRUMPF to establish a production facility there. In 2007, the company establishes TRUMPF Machine Tools Co. Ltd. in Taicang, 50 kilometers north of Shanghai. TRUMPF continues to produce high-tech products such as lasers, control elements and motion units outside

of China and to import them.

READY FOR NEW CHALLENGES

Above: (from left to right) Peter Leibinger, Nicola Leibinger-Kammüller and Mathias Kammüller in 2005 upon taking over the management of the company. At the turn of the millennium a new customer center is built in Farmington. At the groundbreaking ceremony, Berthold Leibinger (3rd from left) and his son-in-law Mathias Kammüller (2nd from right) stand out in their light-colored trench coats. Below: The Litzingen campus expands to include the training center, the sales and service center and a laser factory. Mathias Kammüller and Nicola Leibinger-Kammüller visiting the subsidiary in Japan in 2007.

2010

CLEAR EDGE

Südblech trade show in Sinsheim in 2002. Employees set up a bending machine.



LASER FACTORY, DITZINGEN

The roof landscape laid out in strips that are alternately tilted upwards and downwards is the defining feature of the production halls on the Ditzingen campus. The diamond-shaped openings ensure that the work areas are optimally lit.



Modern
factory



New work

DIGITAL BEGINNERS

Computers and electronics have become an indispensable part of everyday work and production. At the beginning of the millennium, this often means working on large screens and computers.

TECHNOLOGY HIGHLIGHT

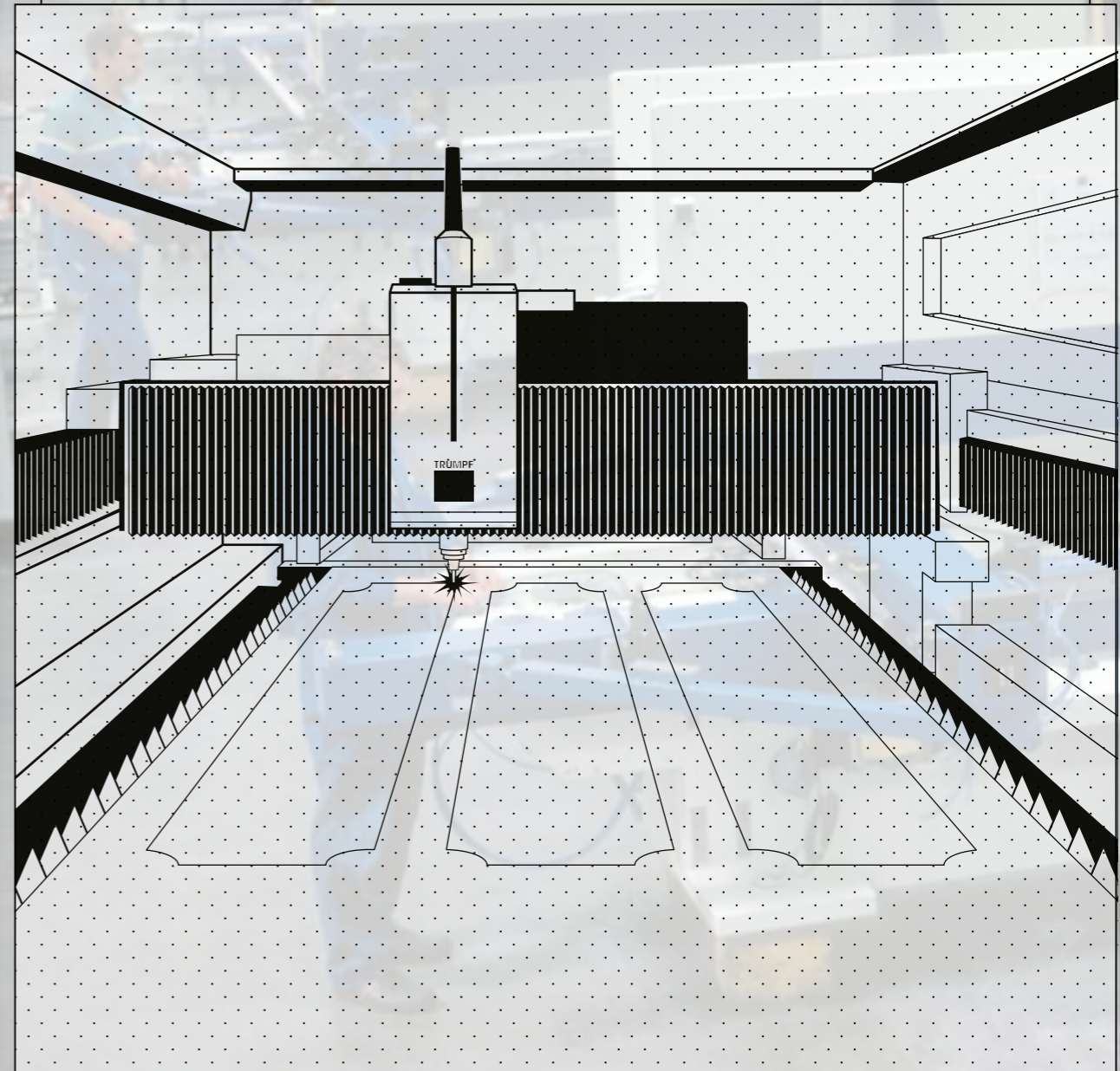

TRULASER 5030 FIBER

The TruLaser 5030 fiber works quickly and enables reproducible, high part quality even when cutting complex contours. Thanks to the solid-state laser with up to 24 kW of laser power, the machine achieves excellent feed rates. Assistance systems make the complete machining process more productive and reliable than ever. The benefits: operator involvement is low, non-productive times are minimal, and parts costs are low. The machine features a powerful drive and dynamic axis movements, even for complex contours. Depending on the model, it cuts even fine contours in thick structural steel and oversize sheets.

11,700 kg
Weight

220 cm
Height

35 mm
Sheet thickness

TRUMPF

TECHNOLOGY
HIGHLIGHT

work

TRUMPF 5000 FIBER LASER
The TruPaser 5030 fiber works quickly and enables reproducible part quality even when cutting complex contours. The solid-state laser with up to 54 kW of laser power, the TRULAS 5000 FIBER, is the complete machining process more productive and reliable than ever. The benefits: operator involvement is low, non-productive times are minimal, and parts costs are low. The machine features a powerful drive and dynamic axis movements. The machine features a powerful drive and dynamic axis movements. The machine features a powerful drive and dynamic axis movements.

DIGITAL BEGINNERS
Computers and electronics have become indispensable for every workday. At the beginning of the millennium, this means working on large screens and computers.



THE TC 500 ASSEMBLY LINE IN HETTINGEN.

TRUMPF supplies large numbers of the machine (1920) from 1991 to 2004. Employees assemble and adjust the coordinate guide that guides the inserted sheet metal for punching.

Microchips

TINY HIGH-PERFORMANCE COMPUTERS

Introducing the control centers of smartphones and computers: microchips. To produce them, lithography systems project light onto silicon wafers in a way that is similar to a photocopier machine. EUV technology makes it possible to fit 80 billion transistors on chips the size of a fingernail.

HIGH-TECH SOLUTIONS FOR THE WORLD

Without the most powerful pulsed industrial lasers from TRUMPF, no modern smartphone would work today. The huge systems are built in clean rooms and consist of metal, electronics, and a lot of engineering expertise. An EUV laser weighs more than ten tons.

AGE OF MICRO-ELECTRONICS



2011— 2022

AGE OF MICRO-ELECTRONICS

- Fridays for Future
- Ultra HD
- Zmarwatch
- COVID-19
- Brexit
- Fukushima
- Donald Trump
- Greek sovereign debt crisis
- TikTok
- Pokémon GO
- ChatGPT
- New Silk Road
- Arab Spring
- Germany wins the World Cup
- Black Lives Matter
- Russian war of aggression against Ukraine
- Charlie Hebdo attack
- Refugee crisis in Germany
- Death of David Bowie
- Death of Queen Elizabeth II
- Notre Dame fire
- 2G mobile communications
- Kevin McCoy's NFT artwork "Quantum"
- Znaphat

Microchips SOS

THE HIGH-PERFORMANCE COMPUTERS
 Introducing the central centers of
 smartphones and computers: microchips.
 To produce them, lithography systems
 project light onto silicon wafers in a
 way that is similar to a photocopier
 machine. EUV technology makes it possi-
 ble to fit 8 billion transistors on a
 chip the size of a fingernail.

HIGH-TECH SOLUTIONS FOR THE WORLD

Without the most powerful pulsed industrial lasers from TRUMPF, no modern smartphone would work today. The huge systems are built in clean rooms and consist of metal, electronics, and a lot of engineering expertise. An EUV laser weighs more than ten tons.

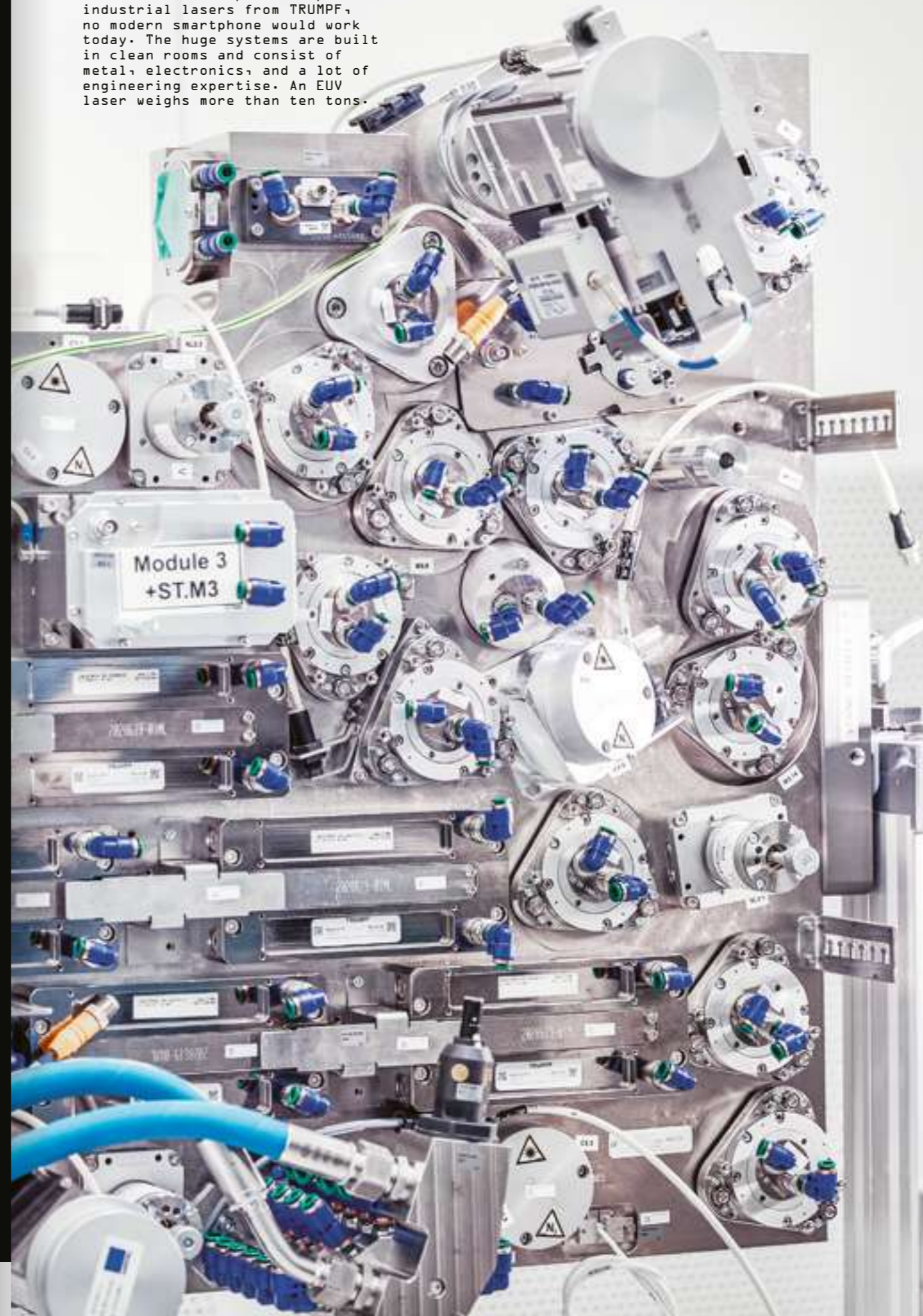

Smart Factory Chicago

NETWORKED INDUSTRY

In 2017, TRUMPF completes its demonstration and sales center near Chicago. The production chain for sheet metal components consists of high-tech machines and pioneering production processes.



Live & work



INNOVATION AND RESPONSIBILITY

Above: For their application "Producing with flashes of light - ultrashort pulse lasers for industrial mass production," researchers from TRUMPF, Bosch and the University of Jena receive the German Future Prize in 2013. Peter Leibinger celebrates with award winner Dirk Sutter. TRUMPF's new logistics center in Ditzingen has a storage area equal to around three soccer pitches and is used as a spare parts and shipping warehouse. The automated small parts warehouse there has 23,000 bin locations. Below: The daycare center in Ditzingen can accommodate 75 children of TRUMPF employees and from the community. Nicola Leibinger-Kammüller with her sister Regine Leibinger, who has played a key role in shaping architecture in the TRUMPF Group since the late 1990s with her Berlin-based architectural firm Barkow Leibinger.

AGE OF MICRO- ELECTRONICS

The sovereign debt crisis dominates the eurozone in the early 2010s. Countries such as Greece, Spain and Italy struggle with huge budget deficits and high rates of unemployment. The heads of state and government of the common currency zone decide on the European Stability Mechanism (ESM), a rescue package designed to provide emergency loans and guarantees to the affected countries.

DIGITALLY NETWORKED MACHINES

Microelectronics, on the other hand, experience a real boom in these and the following years of the decade: Smartphones are equipped with their first voice recognition functions, mobile communications technologies reach the masses, and artificial intelligence and 5G become widespread. During this time, TRUMPF also breaks new ground and benefits in many ways from the innovative leaps in semiconductors.

In 2011, for example, when business representatives first unveil the concept of digitally networked production at Hannover Messe with the slogan "Industry 4.0", TRUMPF is already raring to go. The company had launched its "TruTops Fab" production control software in 2010 and since then, had been networking more and more machine tools and industrial lasers for use in areas such as the automotive industry.

However, networked manufacturing at TRUMPF reaches its preliminary peak with the first Smart Factory in Chicago in the US in 2017. The engineers had planned for the technology center there to be completely equipped with digitally networked production processes. Advising and supporting customers in introducing manufacturing solutions of this kind is still the core task of the team there today. Smart Factories in Ditzingen, Taicang and Farmington follow later.

THE MOST POWERFUL CHIPS THANKS TO LASERS

TRUMPF achieves at least as much success with its lasers for semiconductor lithography systems, which enable the most powerful microchips in the world to be produced. After about ten years of development, TRUMPF delivers the first series systems for a high-performance

laser to Dutch technology giant ASML. With the aid of this laser, the company can for the first time process microchips with very short-wave light, also known as extreme ultraviolet light ("EUV"). As a result, more than ten billion transistors can suddenly be accommodated on a single microchip – and the chips perform many times better than anything previously available. To do this, the TRUMPF laser fires 50,000 miniscule droplets of tin per second. As a result, they heat up to 220,000 degrees to form a plasma and emit particularly short-wave light with a wavelength of 13.5 nanometers. No new smartphones or modern computers work today without these chips produced using EUV.

E-CARS AND AN ALLIANCE FOR WORK

The innovative leap in microelectronics makes it possible to develop other technologies that cannot be produced economically without lasers: complex battery management systems and power electronics help electromobility achieve a breakthrough. TRUMPF quickly leads the way in this area, particularly when it comes to green lasers.

Apart from technology, TRUMPF continues to develop in other areas too during this decade, with both employer and employee sides agreeing on an "Alliance for Work," one of the most modern company agreements. The agreement regulates mobile working, flexible working time accounts and the right to further training.

NEW MARKETS, NEW TECHNOLOGIES

In the decade of microelectronics, TRUMPF also expands into new markets. In 2013, the company enters into a cooperative venture with Chinese machine tool manufacturer Jiangsu Jinfangyuan CNC Machine Company Ltd (JFY) and acquires a majority stake. Back then, TRUMPF has just under 10,000 employees worldwide and sales revenues of around 2.3 billion euros.

In 2015, TRUMPF takes over "Eisen- und Hammerwerke Teningen" (EHT), one of the oldest companies in Germany. The company in Breisgau boasts a history of almost 250 years, having been founded in 1771, and manufactures bending machines, among other things.

LASER DIODES FOR APPLE

Laser diodes from TRUMPF help smartphones save power and avoid accidental contact. Among other things, they are used in Apple's iPhone. In the foreground, TRUMPF technicians inspect the hair-width sensors to ensure high quality contacts.

2011– 2022

AGE OF LIVE MICRO-ELECTRONICS & LASERS

The sovereign debt crisis dominates the eurozone in the early 2010s. Countries such as Greece, Spain and Italy struggle with huge budget deficits and high rates of unemployment. The heads of state and government of the common currency zone decide on the European Stability Mechanism (ESM), a rescue package designed to provide emergency loans and guarantees to the affected countries.

Microelectronics, on the other hand, experience a real boom in these and the following years of the decade. Smartphones are equipped with their first voice recognition functions, mobile communications technologies teach the masses, and artificial intelligence and 5G become widespread. During this time, TRUMPF also prescribes new ground and benefits in many ways from the innovation leads in semiconductor technology.

In 2011, for example, when business representatives first unveil the concept of intelligent manufacturing, TRUMPF already has the slogan "Industry 4.0" ready to go. The company has launched a new production control software in 2010 and since then has been networking more and more machine tools and industrial lasers to use in areas such as the automotive industry.

However, networked manufacturing at TRUMPF reaches its preliminary peak with the first Smart Factory in Chicago in the US in 2017. The engineers had planned for the technology center to be completely equipped with a digitally networked production process. Advising and supporting customers in introducing manufacturing solutions of this kind will be the core task of the team there. Smart factories in Ditzingen, Tetschen and Farmington follow later.

THE MOST POWERFUL CHIPS THANKS TO LASERS

TRUMPF achieves such success with its lasers for semiconductor lithography systems, which enable the most powerful microchips in the world to be produced. After about ten years of development, TRUMPF delivers the first series systems for a high-performance

In the decade of microelectronics, TRUMPF also expands into new markets. In 2013, the company enters into a cooperative venture with Chinese machine tool manufacturer Jiansu Jintangyan CNC Machine Company Ltd (JY) and acquires a majority stake. Back then, TRUMPF has just under 10,000 employees worldwide and sales revenues of around 2.3 billion euros.

In 2015, TRUMPF takes over "Eisen- und Hammerwerke Tenningen" (EHT), one of the oldest companies in Germany. The company in Breisgau boasts a history of almost 250 years, having been founded in 1771 and manufactures bending machines, among other things.

The sovereign debt crisis dominates the eurozone in the early 2010s. Countries such as Greece, Spain and Italy struggle with huge budget deficits and high rates of unemployment. The heads of state and government of the common currency zone decide on the European Stability Mechanism (ESM), a rescue package designed to provide emergency loans and guarantees to the affected countries.

Microelectronics, on the other hand, experience a real boom in these and the following years of the decade. Smartphones are equipped with their first voice recognition functions, mobile communications technologies teach the masses, and artificial intelligence and 5G become widespread. During this time, TRUMPF also prescribes new ground and benefits in many ways from the innovation leads in semiconductor technology.

In 2011, for example, when business representatives first unveil the concept of intelligent manufacturing, TRUMPF already has the slogan "Industry 4.0" ready to go. The company has launched a new production control software in 2010 and since then has been networking more and more machine tools and industrial lasers to use in areas such as the automotive industry.

However, networked manufacturing at TRUMPF reaches its preliminary peak with the first Smart Factory in Chicago in the US in 2017. The engineers had planned for the technology center to be completely equipped with a digitally networked production process. Advising and supporting customers in introducing manufacturing solutions of this kind will be the core task of the team there. Smart factories in Ditzingen, Tetschen and Farmington follow later.

THE MOST POWERFUL CHIPS THANKS TO LASERS

TRUMPF achieves such success with its lasers for semiconductor lithography systems, which enable the most powerful microchips in the world to be produced. After about ten years of development, TRUMPF delivers the first series systems for a high-performance

INNOVATION AND RESPONSIBILITY

Above: For their application "Producing with flashes of light - ultrashort pulse lasers for industrial mass production," researchers from TRUMPF, Bosch and the University of Jena receive the German Future Prize in 2013. Peter Leibinger celebrates with award winner Dirk Sutter. TRUMPF's new logistics center in Ditzingen has a storage area equal to around three soccer pitches and is used as a spare parts and shipping warehouse. The automated small parts warehouse there has 23,000 bin locations. Below: The daycare center in Ditzingen can accommodate 75 children of TRUMPF employees and from the community. Nicola Leibinger-Kammüller with her sister Regine Leibinger, who has played a key role in shaping architecture in the TRUMPF Group since the late 1970s with her Berlin-based architectural firm Barkow Leibinger.



LASER DIODES FOR APPLE
Laser diodes from TRUMPF help smartphones save power and avoid accidental contact. Among other things, they are used in Apple's iPhone. Beforehand, TRUMPF technicians subject the hair-width sensors to extensive quality controls.

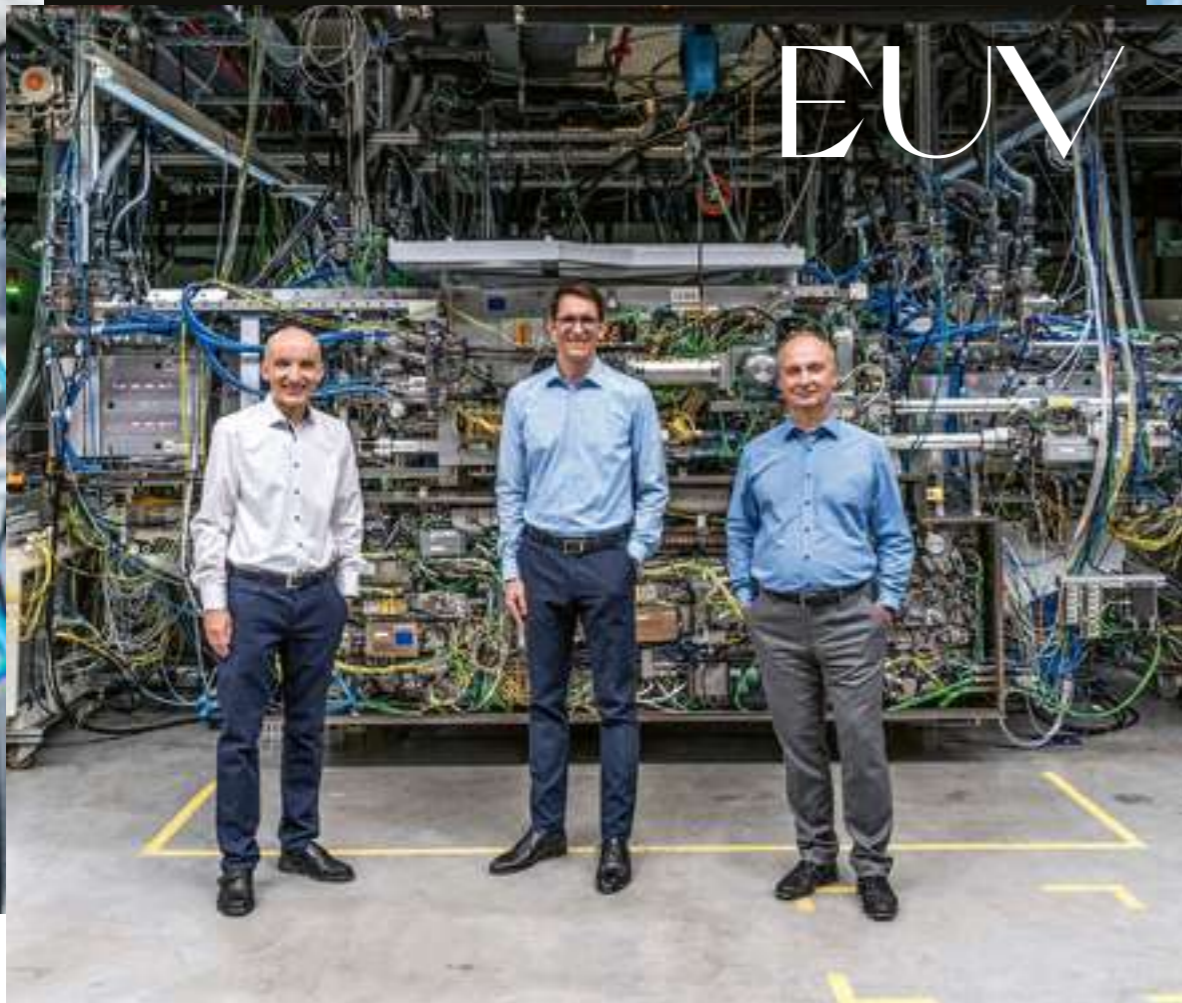

HONORED BY THE GERMAN PRESIDENT

Above: A TRUMPF employee prepares a measurement. Representing all the TRUMPF, ZEISS and Fraunhofer employees involved in the EUV "Generation Project", three employees receive the German Future Prize in 2020. The picture shows award winners Peter Kürz, Michael Kösters and Sergiy Yulin (from left to right).

TECHNOLOGY HIGHLIGHT

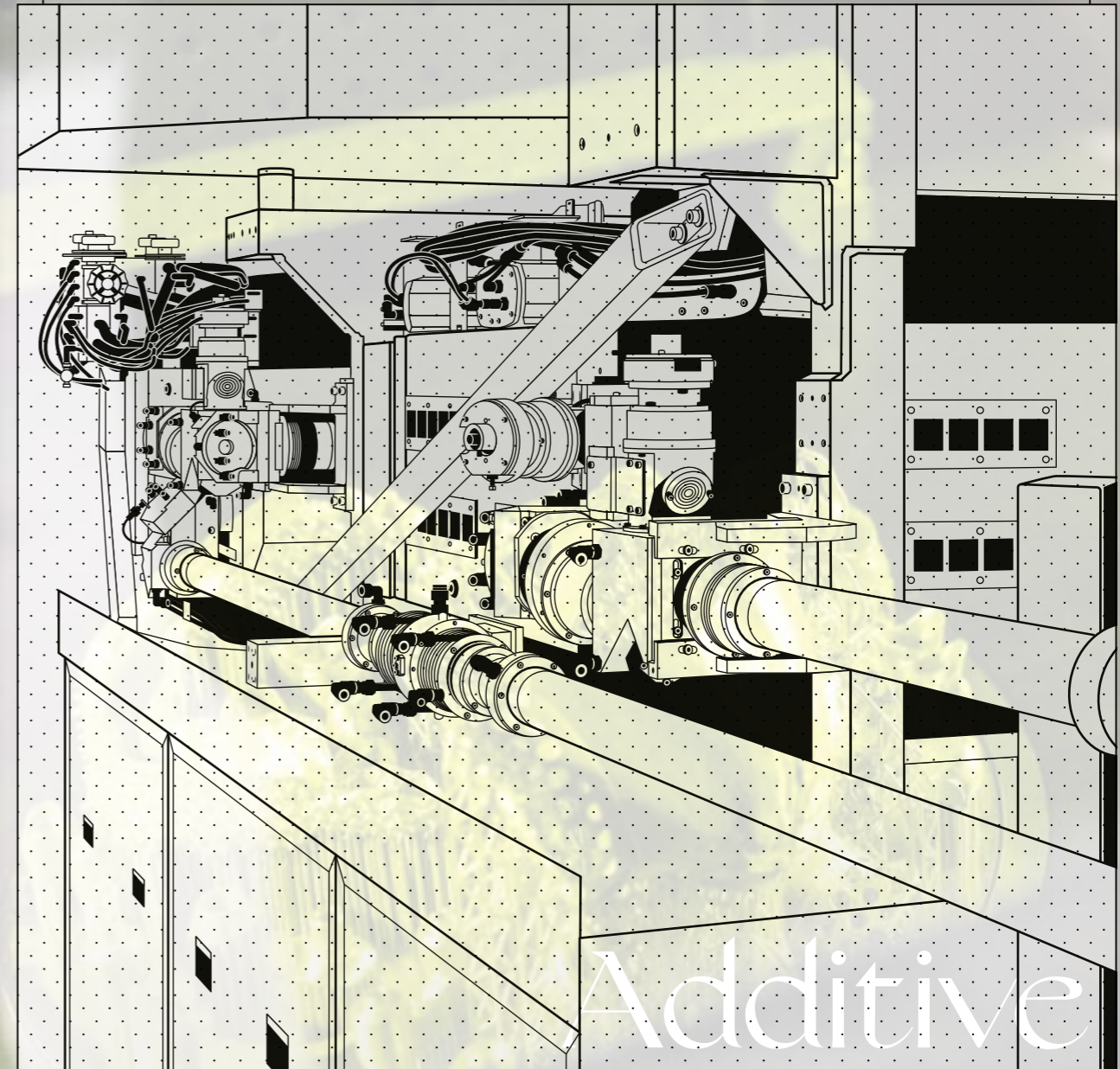

Additive manufacturing

TRUMPF LASER AMPLIFIER FOR EUV LIGHT

A key challenge in EUV lithography is to generate light with an extremely short wavelength. To do this, a tin generator fires 50,000 tin droplets per second into a vacuum chamber, while a laser pulse hits the droplets as they rush by. The laser heats the tin droplets to 220,000 degrees, which is about 45 times hotter than the sun. This creates a plasma flash with the desired wavelength of 13.5 nanometers. TRUMPF has developed a unique beam source based on its CO₂ laser technology for this purpose. The TRUMPF laser amplifier amplifies a weak laser pulse in five amplifier stages by more than 10,000 times to over 30 kilowatts of average power, with a peak pulse power of several megawatts.

17,000 kg
Weight

230 cm
Height (Drive Laser)

30 kW
Average output power



TECHNOLOGY
HIGHLIGHT

17,000 kg
Weight

TRUMPF LASER AMPLIFIER FOR EUV LIGHT
A key challenge in EUV lithography is to generate light with an extremely short wavelength. To do this, a tin generator fires 50,000 tin droplets per second into a vacuum chamber, while a laser pulse hits the droplets as they rush by. The laser heats the

...then the sun. This creates a plasma flash with the desired wave length of 13.5 nanometers. TRUMPF has developed a unique source based on its CO₂ laser technology for this purpose. Above: A TRUMPF employee prepares a measurement. Representing all the TRUMPF divisions, the Engineering Division received the Future Prize in 2020. The award was given to Michael Kösters and Sergiy Yulin (from left to right).

HONORED BY THE GERMAN PRESIDENT

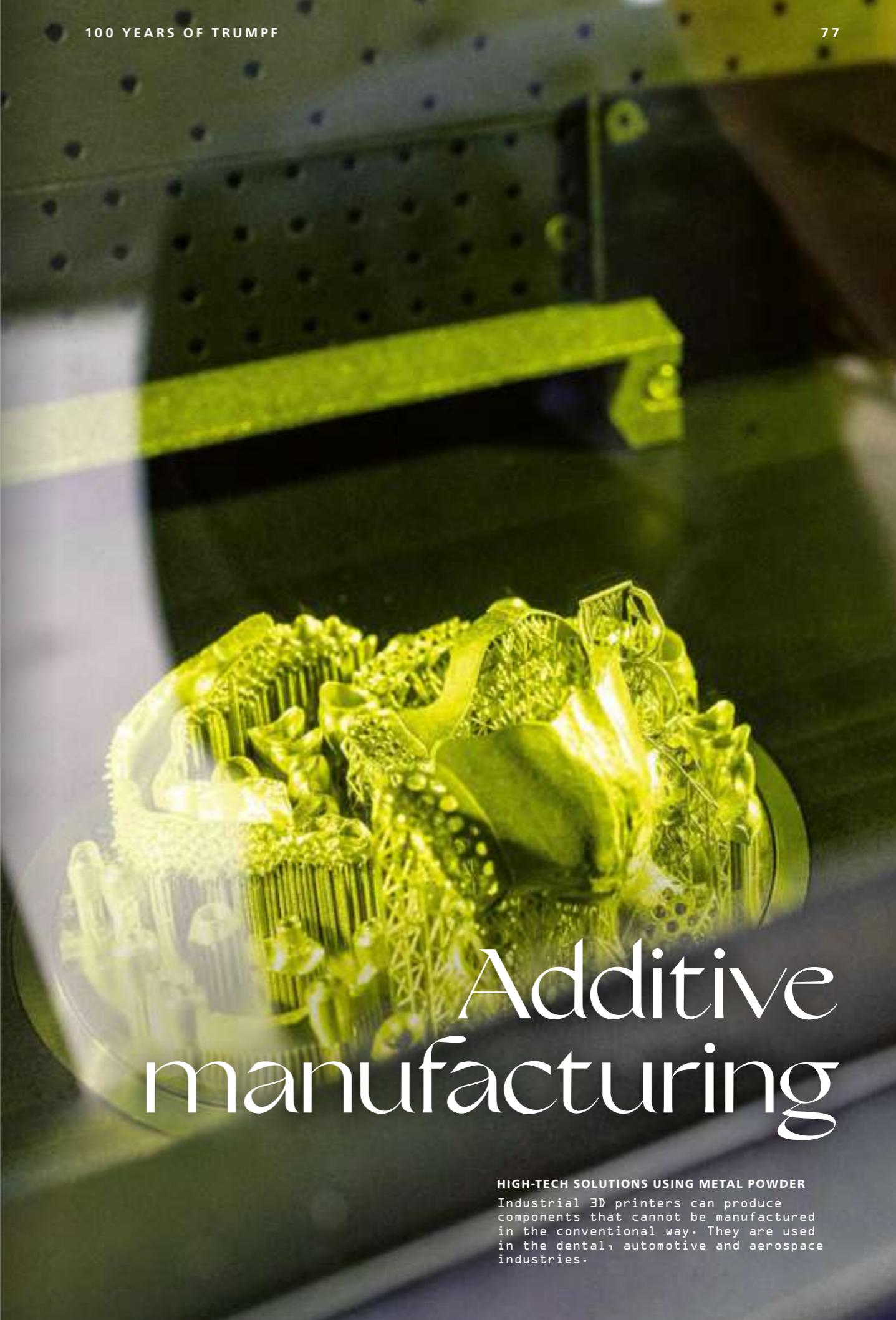

Additive manufacturing

HIGH-TECH SOLUTIONS USING METAL POWDER
Industrial 3D printers can produce components that cannot be manufactured in the conventional way. They are used in the dental, automotive and aerospace industries.

CENTENNIAL YEAR

Earthquakes in Turkey and Syria

Oscar for "All Quiet on the Western Front"

Death of Tina Turner

Second year of war in Ukraine

Worldwide end of the coronavirus pandemic

Nuclear phase-out in Germany

Coronation of King Charles III in the United Kingdom

India most populous country on earth

Ice Hockey World Championship

Women's World Cup

CENTENNIAL GALA UNDER A BANNER OF LIGHTS

680 spotlights in and around the Blauto company restaurant at TRUMPF headquarters in Ditzingen. A stage with 85 square meters of LED screens. And around 1,000 invited guests. This is how TRUMPF celebrates its centennial with customers and prominent representatives from the worlds of politics and science.

2023



CENTENNIAL YEAR



Death of Tina Turner

Second year of war in Ukraine

Top division of the football Bundesliga

Nuclear phase-out in Germany

Cooperation of King Charles III in the United Kingdom

India's most populous country on earth

Ice Hockey World Championship

Women's World Cup

2023



100 1923-2023

CENTENNIAL GALA UNDER A BANNER OF LIGHTS

680 spotlights in and around the Blautopf company restaurant at TRUMPF headquarters in Ditzingen. A stage with 85 square meters of LED screens. And around 500 invited guests. This is how TRUMPF celebrates its centennial with customers and prominent representatives from the worlds of politics and science.



PARTY MILE INSTEAD OF COMPANY CAMPUS

Singing, chatting, dancing: At the "Festival 100" in Ditzingen alone, more than 4,500 employees celebrate TRUMPF's centennial. Among them are many international colleagues, including people from Mexico, the Netherlands, Spain, China, India and Indonesia.

Festival 100



**LASER CLUB**

At the centennial festival, the lawn of the company campus disappears under a huge stage show. Bands and DJs play into the night - and employees dance together like there's no tomorrow.

Worldwide moment



FROM CHINA TO THE US

TRUMPF employees around the world celebrate its centennial. At 3 p.m. German time on July 8, 2023, they join the festival at the company's headquarters and send greetings from the various time zones. A cake is part of the festivities, of course.

THE CENTENNIAL YEAR

OLD TOGETHER, BIG TOGETHER

"Die Fantastischen Vier", one of the oldest and best-known German hip-hop bands, heats up the atmosphere at the employee festival. The band members all come from the vicinity of the company headquarters and know TRUMPF from their childhood days. "We made it," says singer Thomas D. "We're playing at TRUMPF."

Following the end of the coronavirus pandemic, which lasted more than two years, global uncertainties continue to dominate the world economy. The Russian war of aggression in Ukraine has already lasted more than a year and has caused energy prices in Germany to rise sharply, with food prices also rising significantly in the wake of this. In January 2023, the inflation rate in Germany is 8.7 percent. Terms such as "Zeitenwende" (epochal shift), "Energiewende" (energy transition) and "climate-neutral transformation of industry" are shaping the discussion in Germany about economic and social development.

FOCUS ON SUSTAINABILITY

At TRUMPF, too, the INTECH in-house exhibition is all about sustainable manufacturing during this centennial year. This includes technologies to save materials, energy and cutting gas. TRUMPF also showcases processes for reducing or completely avoiding chemicals that are harmful to the environment, for example in automotive production.

At the Laser trade show, the company presents an AI application for lasers that makes manufacturing even more efficient. Electric car manufacturers in particular will benefit from this, as electric motors can be produced in less time – an advantage for local, emission-free e-mobility.

CHANGE IN THE SUPERVISORY BOARD

The key change in this centennial year, however, concerns the leadership of the TRUMPF Group. Jürgen Hambrecht, Chairman of the Supervisory Board for ten years, steps down for age-related reasons. His successor is Peter Leibinger. He is succeeded in the Managing Board by Berthold Schmidt as Chief Technology Officer. Also for age-related reasons, Christian Schmitz leaves the company as the member of the Managing Board responsible for Laser Technology, and is succeeded by Hagen Zimer.

100 YEARS OF TRUMPF

TRUMPF celebrates its centennial with numerous events for customers, business partners and employees. The official celebrations begin on May 12 with a gala evening at the Ditzingen campus. Guests include business partners from all over the world, representatives from science, business, trade associations and politics. Baden-Württemberg's Minister President Winfried Kretschmann gives the keynote speech: "TRUMPF is a calling card for the world that could not be more impressive."

However, the TRUMPF centennial is not just about history and looking back on what has already been achieved. It is also about looking to the future. For this reason, cutting-edge technology also plays a significant role that evening, with ceremonial speeches, panels and the entire performance focusing on topics of the future – from lasers to quantum technology.

A WORLDWIDE CELEBRATION

The celebrations on July 8 are also among the highlights of the centennial year. In Ditzingen alone, around 4,500 employees come together to celebrate TRUMPF. Worldwide, around 12,000 TRUMPF employees and their families gather on this day – from Taiwan to Mexico.

The visual highlight of the centennial year is one of the most powerful show lasers in the world, which bathes the campus in Ditzingen in green light during the first week of August. Exactly 100 years after the company was entered in the commercial register, the beam of a converted industrial laser from the company shines within a radius of around 80 kilometers.

2023

THE CENTENNIAL YEAR Worldwide moment

100 YEARS OF TRUMPF

TRUMPF celebrates its centennial with numerous events for customers, business partners and employees. The official celebrations begin on May 12 with a gala evening at the Ditzingen campus. Guests include business partners from all over the world, representatives from science, business, trade associations and politics. Baden-Württemberg's Minister President Winfried Kretschmann gives the keynote speech: "TRUMPF is a calling card for the world that could not be more impressive."

However, the TRUMPF centennial is not just about history and looking back on what has already been achieved. It is also about looking to the future. For this reason, cutting-edge technology also plays a significant role that evening, with ceremonial speeches, panels and the entire performance focusing on topics of the future – from lasers to quantum technology.

A WORLDWIDE CELEBRATION

The celebrations on July 8 are also among the highlights of the centennial year. In Ditzingen alone, around 4,500 employees come together to celebrate TRUMPF World. Worldwide, around 12,000 TRUMPF employees and their families gather on this day – from Taiwan to Mexico.

The visual highlight of the centennial year is one of the most powerful show lasers in the world, which bathes the campus in Ditzingen in green light during the week of August 6-8, 100 years after the company was entered in the commercial register, the beginning of a converted industrial laser from the company's history within a radius of around 80 kilometers.

Following the end of the coronavirus pandemic, which lasted more than two years, global uncertainties continue to dominate the world economy. The Russian war of aggression in Ukraine has already lasted more than a year and has caused energy prices in Germany to rise sharply. In January 2023, the inflation rate in Germany is 8.7 percent. Terms such as "Energiewende" (energy transition) and "climate-neutral transformation of industry" are shaping the discussion in Germany about economic and social development.

FOCUS ON SUSTAINABILITY

At TRUMPF, too, the INTECH in-house exhibition is all about sustainable manufacturing during this centennial year. This includes technologies to save materials, energy and cutting gas. TRUMPF also shows processes for reducing or completely avoiding chemicals that are harmful to the environment, for example in automotive production.

At the Laser trade show, the company presents an AI application for lasers that makes manufacturing even more efficient. Electric car manufacturers in particular will benefit from this, as electric motors can be produced in less time – an advantage for local, emission-free e-mobility.

CHANGE IN THE SUPERVISORY BOARD

The key change in this centennial year is however, certainly the leadership of the TRUMPF Group. Jürgen Hampecht, Chairman of the Supervisory Board for ten years, steps down for age-related reasons. His successor is Peter Reisinger. He is succeeded in the Management Board by Bernhard Schmidt as Chief Technology Officer. Also for age-related reasons, Christian Schmitt leaves the company as the member of the Managing Board responsible for Laser Technology, and is succeeded by Hagen Zimmer.

FROM CHINA TO THE US

TRUMPF employees around the world celebrate its centennial. At 3 p.m. German time on July 8, 2023, they join the festival at the company's headquarters and send greetings from the various time zones. A cake is part of the festivities, of course.

2023



OLD TOGETHER, BIG TOGETHER

"Die Fantastischen Vier", one of the oldest and best-known German hip-hop bands, heats up the atmosphere at the employee festival. The band members all come from the vicinity of the company headquarters and know TRUMPF from their childhood days. "We made it," says singer Thomas D. "We're playing at TRUMPF."



GREEN LIGHT OVER STUTTGART

On August 6, the actual day of the centennial, TRUMPF lights up the sky at its headquarters with one of the most powerful show lasers in the world. Together with Lightline, the show laser manufacturer, around 35 experts from the company have converted an industrial high-performance laser into an event laser. Normally, a system of this kind is used to weld batteries for electromobility, for example.



THE FUTURE WITH TRUMPF

Looking
to
tomorrow

Ultrashort
pulse laser

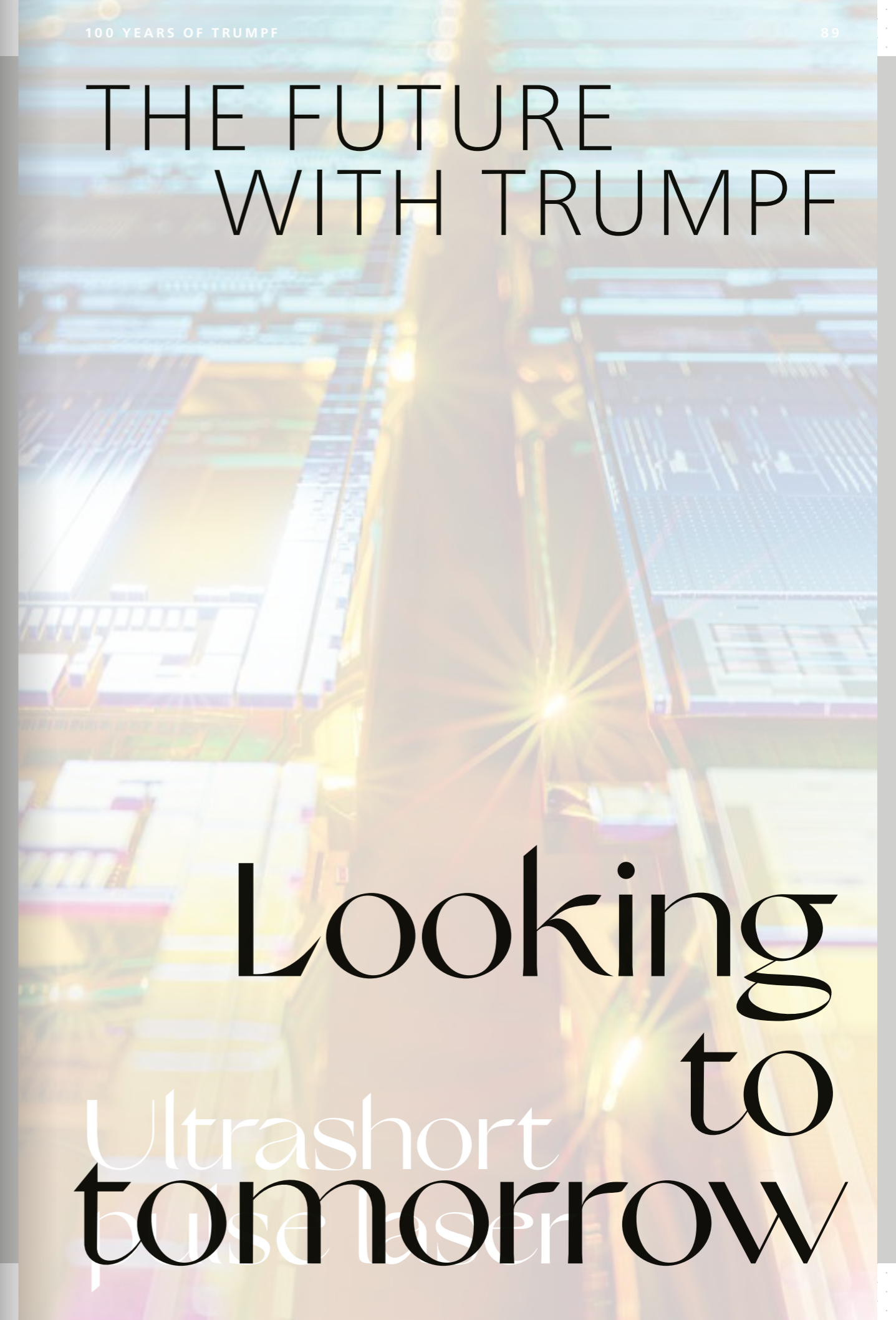
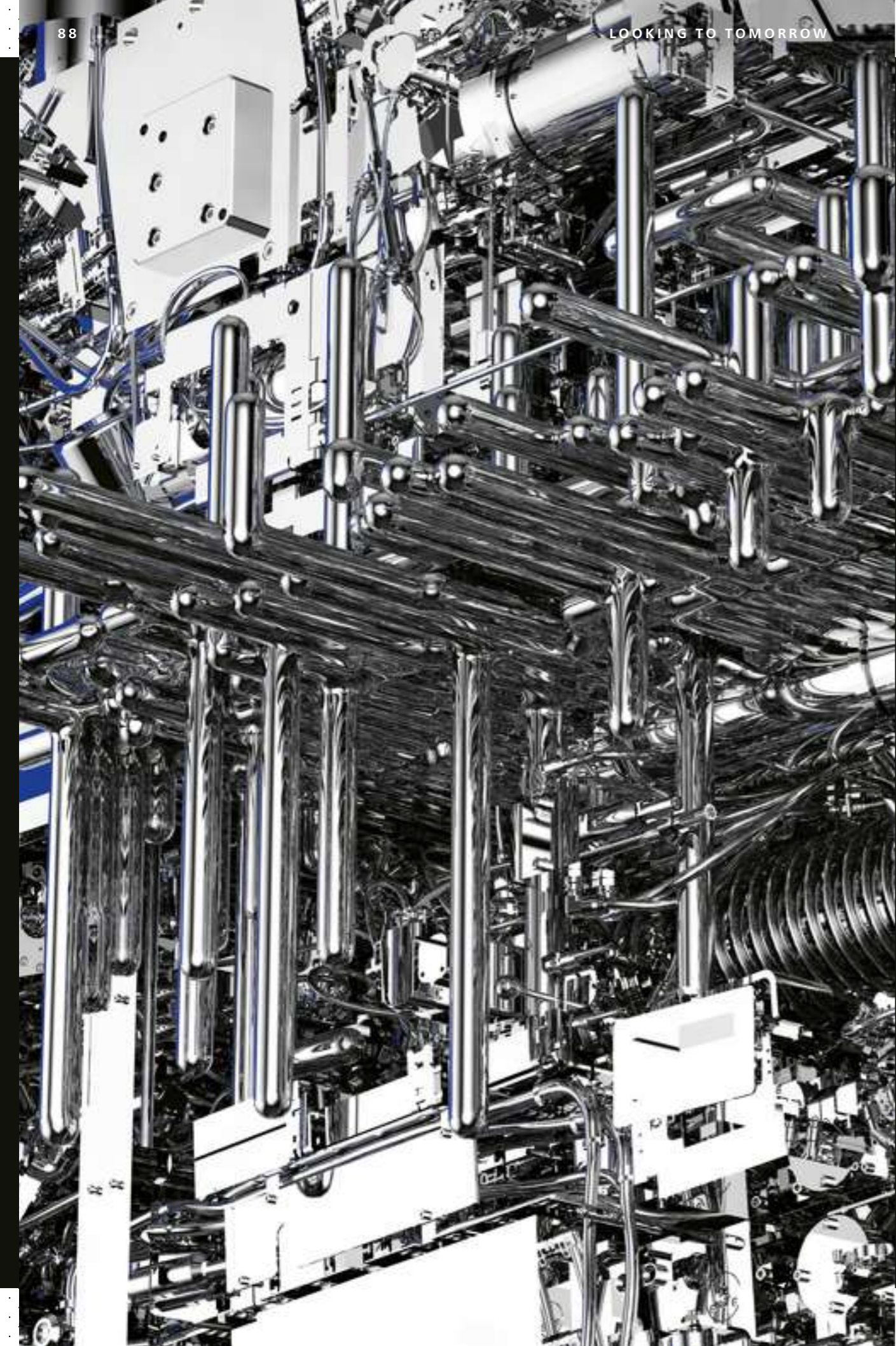

THE FUTURE
WITH TRUMPF

Looking
to
Tomorrow

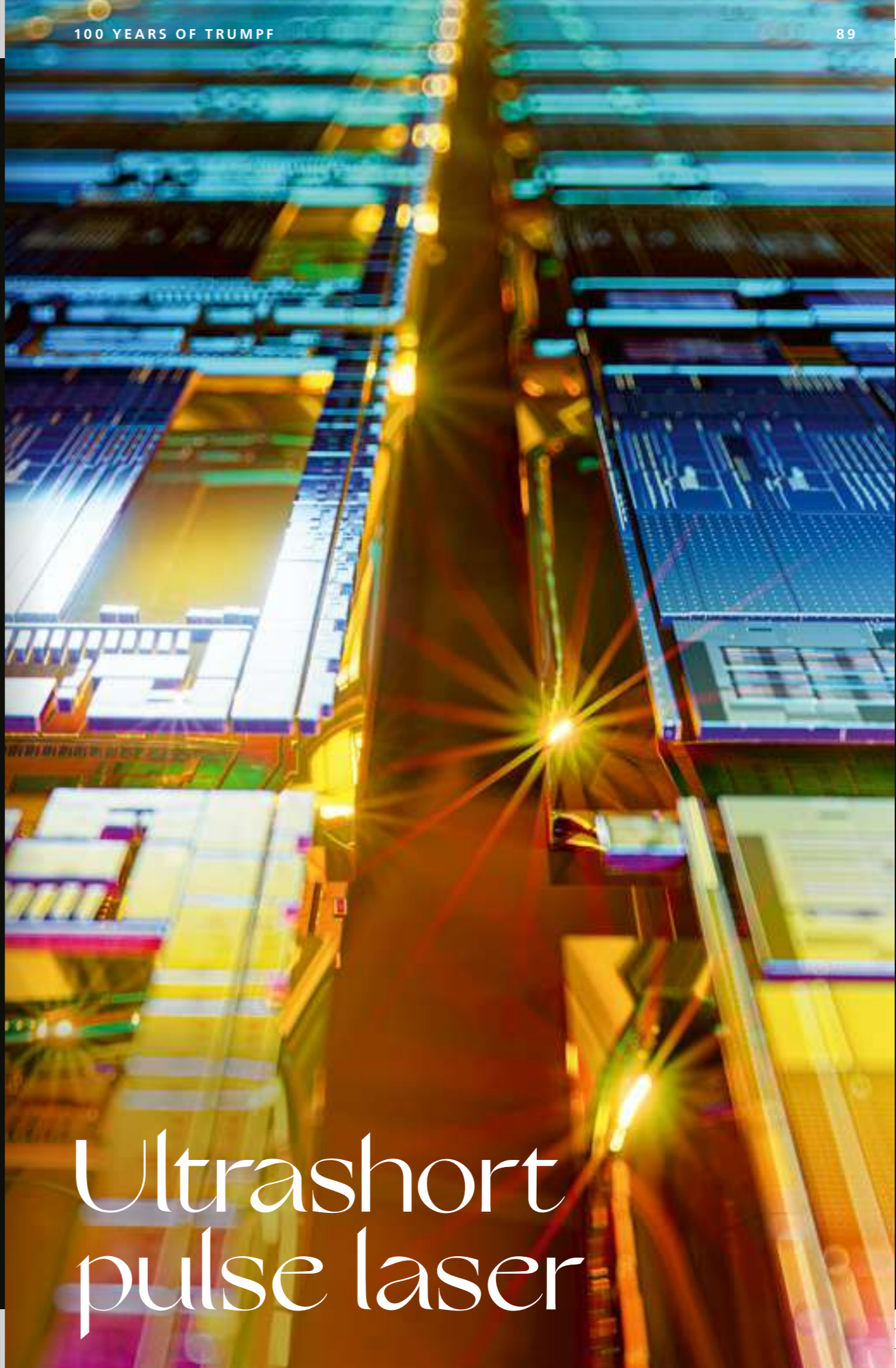

Ultrashort
pulse laser

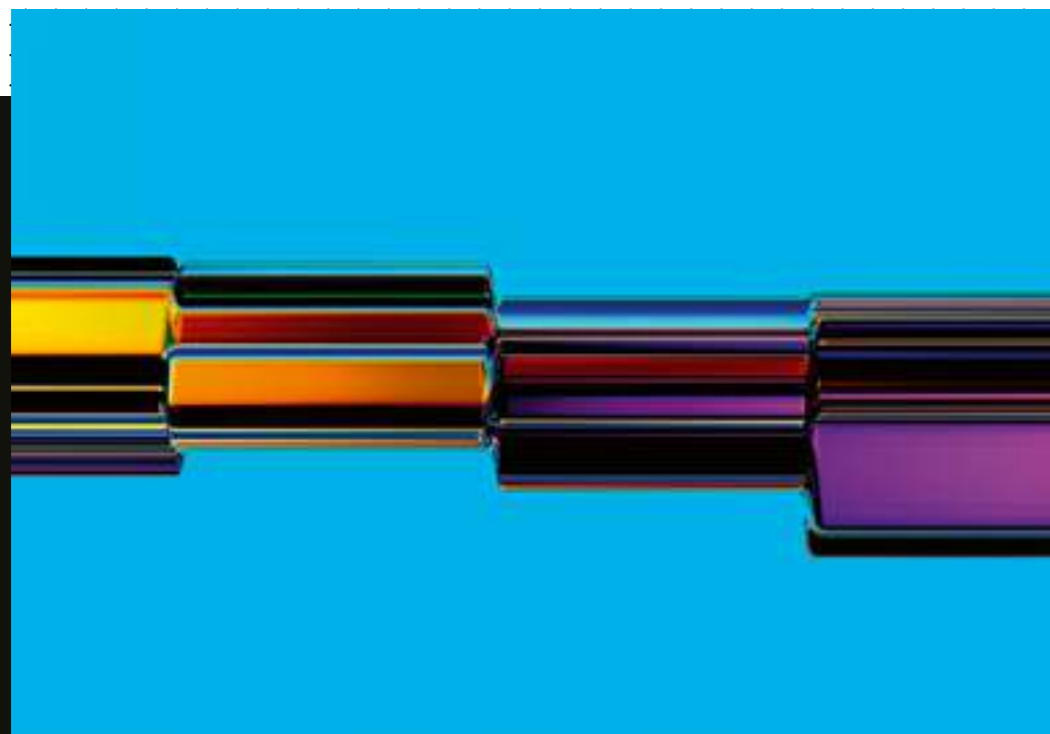

GAMECHANGER FOR INDUSTRY

No industrial company will be able to ignore quantum technology in the future. The US alone will be investing around 20 billion dollars in it by the end of the decade. TRUMPF is taking a two-pronged approach to this future topic. Firstly, the company's physicists and engineers are already feeding quantum computers with problems in order to find new solutions for production.

And secondly, TRUMPF's wholly-owned subsidiary Q.ANT has brought the first industrial-grade quantum sensors to market. In future, these sensors should enable users to perform a variety of tasks, from controlling prostheses with their minds to measuring the states of tiny gas particles on a large scale. Q.ANT has also developed a quantum computer chip that should make it possible to use powerful quantum computers without having to cool them to extreme sub-zero temperatures, as is usually the case.

3D printing

Artificial intelligence



MANUFACTURING THAT THINKS FOR ITSELF

Artificial intelligence (AI) is already ensuring greater efficiency, improved quality and more sustainability in manufacturing thanks to fewer rejects. TRUMPF would like to take on the role of lead user and lead supplier in this area too in future. Today, AI is already calculating the best way for full-service laser machines to sort and select sheet metal parts - or identifying the best place for welding robots to position their seams when producing electric car engines.

THE FUTURE WITH TRUMPF

TRUMPF has always focused on its customers and partners when developing modern manufacturing solutions and products, and taking a technological and entrepreneurial leadership role remains the company's goal. TRUMPF will continue to supply new technologies that will enable society to meet the challenges of the coming years and decades.

LASERS FOR ENVIRONMENTALLY FRIENDLY DRIVES AND HYDROGEN

E-mobility has found its way into the mass market. Market analysts expect that in Europe alone every second car will be an electric car by 2028 – and six out of seven will be by 2035. But car manufacturers can only produce high-quality batteries, electric engines and power electronics efficiently with the help of networked manufacturing solutions. These include lasers, optics, sensors and software. TRUMPF is a global leader in these systems thanks to its wealth of experience.

The company can also play to its strengths when it comes to hydrogen. For example, it is almost impossible to economically manufacture the stack, which is the core of the fuel cell, without a laser. The same applies to electrolyzers, which produce the hydrogen. The potential is huge: to achieve the goal of climate neutrality, experts reckon that up to 600 million tons of green hydrogen will have to be traded. This means the global market is likely to reach a volume of around 1.4 trillion US dollars in 2050.

LASERS FOR SECONDARY BEAM SOURCES

EUV lasers from TRUMPF have enabled the production of state-of-the-art high-performance microchips for several years. This was made possible by a developmental leap in laser technology to particularly high power and short pulses. EUV was one of the first successful secondary beam sources. These are lasers that cause something else to radiate, leading to innovative processes (see also p. 76 right).

Secondary beam sources open up a whole new world of the future. Beams generated by lasers can gently heal skin cancer and penetrate barrels of radioactive material without even scratching the surface. At some point, fusion power plants could even generate clean energy with the help of lasers. It is not yet possible to put a precise figure on the market for this, but experts agree that, if successful, it could be worth hundreds of billions of euros.

NO ROCKETS CAN FLY INTO SPACE WITHOUT LASERS

Commercial space travel is not possible without 3D printers. Today, TRUMPF technology is already being used in the rapidly growing aerospace industry known as New Space. Aerospace companies use lasers to weld rockets and 3D printers to manufacture thrusters for space shuttles and satellites, for example. According to one forecast, the market volume for commercial space services alone is expected to increase to 459 billion US dollars by 2030. Market volumes for commercial rockets and satellite hardware are also expected to grow significantly.

POWER AMPLIFIERS FOR PARTICLE ACCELERATORS

Scientists need the giant particle accelerators for basic and materials research, and doctors are increasingly using them for low-impact and precise cancer therapies. In the chemical, pharmaceutical and manufacturing industries, particle accelerators enable deep insights into substances and materials through X-ray imaging, thereby acting as a catalyst for innovation. TRUMPF Hüttinger develops and produces the technological heart of particle accelerators: power amplifiers that accelerate elementary particles almost to the speed of light. The market for irradiation equipment in heavy ion and proton therapy for cancer alone is estimated by experts to be worth around 10 billion euros. And upcoming major projects, such as the Future Circular Collider at CERN in Switzerland, are likely to use particle accelerators worth around 400 million euros.

Particle Looking to
accelerator tomorrow

Artificial intelligence

Secondary beam sources open up a whole new world of the future. Beams generated by lasers can gently heat skin cancer and penetrate barrels of radioactive materials without even scratching the surface. At some point, laser-based power plants will even generate clean energy with the help of lasers. It is not yet possible to put a precise figure on the market for this, but experts agree that, if successful, it could be worth hundreds of billions of euros.

NO ROCKETS CAN FLY INTO SPACE WITHOUT LASERS

Commercial space travel is not possible without 3D printers. Today TRUMPF technology is already being used in the rapidly growing aerospace industry. For example, as New Space. Aerospace companies use lasers to produce parts and 3D printers to manufacture thrusters for space shuttles and satellites, for example. According to the forecast, the market volume for commercial space services alone is expected to increase to 450 billion dollars by 2030. Market volumes for commercial rockets and satellite hardware are also expected to grow significantly.

POWER AMPLIFIERS FOR PARTICLE ACCELERATORS

Scientists need the giant particle accelerators for basic and materials research, and doctors are increasingly using them for low-impact and precise cancer therapies. In the chemical, pharmaceutical and manufacturing industries, particle accelerators enable deep insights into substances and materials through X-ray imaging, there by acting as a catalyst for innovation. TRUMPF Hüttinger develops and produces the technological heart of particle accelerators: power amplifiers that accelerate elementary particles almost to the speed of light. The market for this equipment is heavy ion and proton therapy for cancer alone is estimated by experts to be worth around 1 billion euros. And upcoming major projects, such as the Future Circular Collider at CERN in Switzerland, are likely to use particle accelerators worth around 400 million euros.

MANUFACTURING THAT THINKS FOR ITSELF

Artificial intelligence (AI) is already ensuring greater efficiency, improved quality and more sustainability in manufacturing thanks to fewer rejects. TRUMPF would like to take on this role of leader and lead supplier in this area too in future. Today, AI is already calculating the best way for full-service laser machines to sort and select sheet metal parts - or identifying the best place for welding robots to position their seams when producing electric car engines.

worlomot

Particle accelerators



Alternative drives



The TRUMPF story

FACTS AND FIGURES ABOUT
THE HISTORY OF TRUMPF

1923 —

Christian Trumpf acquires the Julius Geiger GmbH mechanical workshop in Stuttgart and produces flexible shafts.

1934 —

The company introduces the first motor-driven hand shears (HSP 201) for cutting sheet metal.

1939 —

In addition to its range of electric hand shears and flexible shafts, TRUMPF also manufactures foot pumps for aircraft construction as a sub-supplier to Elektron-Co. mbH in Bad Cannstatt.

In total, more than one hundred employees work for the company. A third of them are French forced laborers, most of whom come from the town of Vierzon, south of Paris. The production facilities remain undamaged.

1953 —

TRUMPF now has an international presence at trade shows and begins to build up a customer base abroad. Hugo Schwarz becomes a partner and commercial director and works for the company in this position until 1978.

— 1933

An increase in the number of employees makes a move to Weilimdorf necessary.

— 1937

The company is renamed "TRUMPF & Co. formerly Julius Geiger GmbH".

— 1947

Christian Trumpf decides to build a stationary curve shear machine, which is introduced under the name TRUMPF Aushauschere TAS.

— 1948

Due to the new product area, TRUMPF changes its logo in 1948. The spade logo will be in use for more than thirty years.

— 1955

TRUMPF opens a factory in Hettingen in the Swabian Alb.

1956 —

Berthold Leibinger begins an experimental diploma thesis at TRUMPF, working on improving the cutting process for shearing machines.

1961 —

Berthold Leibinger becomes head of design. The company employs 325 people and achieves sales revenues of DM 11 million.

1967 —

TRUMPF unveils the TRUMATIC 20, the first sheet metal processing machine with numerical path control.

1978 —

The new President and CEO of TRUMPF, Berthold Leibinger, returns from a fact-finding trip through the US with a special piece of luggage: a CO₂ laser. In the same year, TRUMPF founds its subsidiary in Yokohama, Japan.

1985 —

TRUMPF gets a new logo. The company employs 1,500 people and achieves sales revenues of nearly DM 300 million.

TRUMPF launches itself as a laser manufacturer, with the first CO₂ laser developed and produced in-house, the TRUMPF LASER TLF 1000.

— 1957

TRUMPF patents the coordinate guide for sheet metal: it is the starting point for NC control, which will soon be used on all machine tools.

— 1963

The first foreign subsidiary is founded in Zug, Switzerland, in 1963. This is followed by a subsidiary in Farmington, US, in 1969.

The first TRUMPF TKF 100 beveler is built.

— 1972

TRUMPF moves its location to Ditzingen. The production conditions and traffic infrastructure in Stuttgart-Weilimdorf are no longer appropriate for the company. Berthold Leibinger and Hugo Schwarz acquire Christian Trumpf's shares and become TRUMPF's sole shareholders. TRUMPF employs 800 people and achieves sales revenues of DM 73 million.

— 1979

TRUMPF moves into laser technology. The company introduces the first combination punch-laser machine, the TRUMATIC 180 LASERPRESS. 500 and 700-Watt CO₂ lasers from the US are used as beam sources.

— 1987

TRUMPF presents another innovation in this field, the TRUMATIC L 3000, a flatbed laser cutting machine with flying optics.

1989

The first 'folded' laser in a TRUMATIC 240 LASERPRESS is presented at EMO in Hannover.

1992

In 1991, "Sächsische Werkzeug- und Sondermaschinen GmbH" under the administration of Treuhandanstalt Berlin begins manufacturing loading equipment for TRUMPF. In 1992, the company is privatized as a subsidiary of the TRUMPF Group.

2003

Opening of the new sales and service center at the Ditzingen location. The company presents the prototype of a disk laser with 4 kW laser power as a world first.

2009

TRUMPF showcases the first highly brilliant multi-kilowatt industrial laser with high-power laser diodes as a direct beam source. The Machine Tool Development Center and the Laser Technology Center are opened in Ditzingen.

2012

On December 31, 2012, Professor Berthold Leibinger steps down as Chairman of the Supervisory Board of the TRUMPF Group for age-related reasons. The company's Supervisory Board elects Dr. Jürgen Hambrecht, former CEO of BASF SE, as his successor.

2014

Foundation of TRUMPF Bank.

1990

The cooperation between HÜTTINGER and TRUMPF that began back in 1986 has developed so well over the years that in 1990, TRUMPF acquires the majority shares in HÜTTINGER.

1998

A new laser factory is inaugurated, making Germany a secure production location.

2005

Dr. Nicola Leibinger-Kammüller becomes Chief Executive officer and Professor Berthold Leibinger takes over as Chairman of the Supervisory Board.

2011

The new Alliance for Work for TRUMPF locations in Germany is adopted. At its core is a highly flexible working time model that takes into account employees' respective life phases and so goes well beyond standard working time contracts.

2013

TRUMPF expands its development headquarters for solid-state lasers in Schramberg with a new development center, thereby adding 6,200 square meters of built space to the company location.

Researchers from TRUMPF, Bosch and the University of Jena are awarded the coveted German Future Prize for their application "Producing with flashes of light – ultrashort pulse lasers for industrial mass production."

TRUMPF acquires a majority stake in Chinese machine tool manufacturer JFY.

2015

TRUMPF takes over EHT Werkzeugmaschinen GmbH in Teningen, one of the oldest companies in Germany.

Establishment of Additive Manufacturing division.

2017

In September 2017, TRUMPF opens the Smart Factory in Chicago, a technology center for Industry 4.0 solutions that works entirely with digitally networked production processes.

2020

In recognition of their project "EUV Lithography – New Light for the Digital Age," German President Frank-Walter Steinmeier awards his prize for technology and innovation to the team of researchers led by Michael Kösters, TRUMPF Laser Systems for Semiconductor Manufacturing, Peter Kürz, ZEISS Semiconductor Manufacturing Technology (SMT) division, and Sergiy Yulin, Fraunhofer Institute for Applied Optics and Precision Engineering IOF in Jena.

TRUMPF opens a new Smart Factory in Ditzingen, Germany – the company's third fully networked factory after Chicago, US, and Taicang, China.

2022

The former TRUMPF GmbH + Co. KG now operates under the name TRUMPF SE + Co. KG.

2016

With its updated Alliance for Work, TRUMPF responds to the challenges of the future such as dynamic brand development, the digital transformation and the need for more individuality.

2019

TRUMPF opens a company daycare center at its headquarters in Ditzingen in May 2019. A total of 70 children can be cared for in the 1,200 square meters building.

2021

Dr. Peter Leibinger receives the Cross of Merit on Ribbon of the Order of Merit of the Federal Republic of Germany.

TRUMPF opens a capital city office near the Brandenburg Gate in Berlin.

At a glance



Company

Managing Board



Hagen
Zimer

Stephan
Mayer

Berthold
Schmidt

Oliver
Maassen

Lars
Grünert

Nicola
Leibinger-
Kammüller

Mathias
Kammüller

Message from the Managing Board

LADIES AND GENTLEMEN,

TRUMPF had an extremely successful fiscal year 2022/23, which ended on June 30, 2023 and marks the first half of the “100 Years of TRUMPF” centennial year.

The company succeeded in increasing **sales revenues** by 27 percent compared to the previous year (4.2 billion euros) to 5.4 billion euros – the highest figure in our company’s history. Never before have we exceeded the 5 billion euro threshold. At 591 million euros, June 2023 was also the strongest single month in our company’s history in terms of sales revenues.

We significantly increased sales revenues in our **home market of Germany**, recording an increase of 32.2 percent to 779 million euros. We were particularly successful in the Americas. In the **US**, our sales revenues were up 38.5 percent to 899 million euros. In **China**, our largest Asian market, we boosted sales revenues by 4.7 percent to 602 million euros.

If we look at the business divisions and selected business fields, the **Machine Tools** division in particular saw sales revenues increase by 32.8 percent to 3,038 million euros. The **Laser Technology** business division also achieved very high growth of 28.0 percent, with sales revenues there rising to 2,059 million euros. Our **EUV business** likewise posted very significant growth, with sales rising by 22.2 percent to 971 million euros.

Our **earnings before interest and taxes (EBIT)** improved by 147 million euros to 615 million euros as a result of the significant growth in revenues compared to the previous year (468 million euros). Despite higher raw material, logistics and personnel costs, the **EBIT margin** was 11.5 percent (previous year: 11.1 percent).

Notwithstanding our satisfaction with sales revenues and earnings, we have also been feeling the effects of the weakening global economy since the beginning of calendar year 2023 in the form of declining orders. Measured against the previous year (5.6 billion euros), our **order intake** fell by 8.8 percent to 5.1 billion euros in the past fiscal year.

Although the outlook for the global economy was subdued, we again increased **investments** in the past fiscal year, in particular in construction measures at various locations worldwide. In addition to Laser Area 4 and the TRUMPF Education Center at our headquarters in Ditzingen, Germany, we invested in various new buildings and expansions, including those in Schramberg, Warsaw and Budapest. Investments increased by 44.7 percent compared to the previous year (218 million euros) to a new all-time high of 316 million euros.

Our company also increased its **shareholdings**. In February 2023, we agreed on a strategic partnership for Smart Factory solutions with STOPA, one of the leading manufacturers of automated storage systems. In this context, TRUMPF acquired a 25.1 percent stake in STOPA Anlagenbau GmbH. In March 2023, we increased our stake in Auroma Technologies Co. Dba Access Laser Company (USA) from 85.0 percent to 100.0 percent.

At 476 million euros, **research and development costs** were significantly higher than in the previous year (448 million euros). Relative to increased sales revenues, the R&D ratio decreased slightly to 8.9 percent (previous year: 10.6 percent), but remained at a very high level, well above the industry average. The number of employees in research and development increased by 8.8 percent to 2,853 (previous year: 2,623).

We increased the **total number of our employees worldwide** from 16,554 in fiscal 2021/22 to 18,352 as of the reporting date of June 30, 2023. New jobs were created in the growth fields of EUV and Electronics in particular, which underscores our aspiration to contribute to value creation and employment with innovations even in difficult times.

In **Germany**, TRUMPF employed 9,124 people as of the balance sheet date of June 30, 2023 (previous year: 8,417). This is nearly half of our global workforce, although Germany’s share of total sales revenues is only 14.5 percent. **Outside Germany**, the number of employees increased by 13.4 percent to 9,228 (previous year: 8,137).

In the year under review, 550 young people also completed a **training course** or co-op work-study program. The training ratio was 3.5 percent.

On behalf of the Managing Board – both the new Board and the one in office until June 30, 2023 – I would like to thank all TRUMPF employees for their commitment in fiscal year 2022/23!

I would like to combine these thanks with an equally big thank you to our loyal customers and business partners, without whom we would have been nowhere near as successful as we have been over the past 100 years – including this past fiscal year!

Ditzingen, October 2023

Dr. phil. Nicola Leibinger-Kammüller
Chairwoman of the Managing Board



Message from the Supervisory Board

LADIES AND GENTLEMEN,

The Ukraine war and increasing geopolitical tensions between the US and China led to bottlenecks and price increases in many value chains in fiscal year 2022/23, and the pace of growth decreased in almost all markets. In this challenging business environment, TRUMPF once again increased sales revenues and earnings, successfully and consistently pursuing its strategy of growth through innovation, portfolio management, and investments, including investments ensuring the company's supply capability.

The Supervisory Board exercised the monitoring and advisory responsibilities incumbent on it under the law and the Group's articles of association with due care and diligence. In doing so, the Supervisory Board and the Managing Board worked together effectively and efficiently in a spirit of trust. The Chairwoman of the Managing Board reported regularly and promptly to the Chairman of the Supervisory Board about all events of significance. In three meetings during the fiscal year, the Supervisory Board addressed the strategic development of the company as a whole, operational excellence and digital transformation, China and high-volume markets, the expansion of business in North America, the future of laser and quantum technology and the Electronics business field, data security, employee satisfaction, talent management, and compliance and auditing. Regular items on the agenda were business development, budget monitoring, risk provisioning, and key future areas such as EUV lithography, additive manufacturing, photonic components, and investment and portfolio projects.

In the fiscal year, the Supervisory Board appointed Dr. Berthold Schmidt as successor to Dr. Peter Leibinger (from July 1, 2023 for three years) and Dr. Hagen Zimer as successor to Dr. Christian Schmitz (from July 1, 2023 for three years) to the Managing Board. Oliver Maassen's contract was extended by five years (from October 1, 2023). We would like to thank Dr. Schmitz for his many years of service to the company.

On the Supervisory Board, the undersigned, Dr. Peter Leibinger, took over as Chairman effective July 1, 2023. Ms. Elke Reichart (effective July 1, 2023) and Mr. Alexander Hasselbacher (effective October 1, 2022) joined the Supervisory Board as new members. We would like to thank departing Supervisory Board members Martin Röll and Prof. Dr. Claudia Eckert for their many years of constructive and trusting cooperation.

PricewaterhouseCoopers GmbH Wirtschaftsprüfungsgesellschaft, Stuttgart, audited the separate and consolidated annual financial statements and the Group Management Report, and issued an unqualified audit opinion in each case. Following presentation by the auditors and having completed their own reviews of the separate and consolidated annual financial statements, the proposed appropriation of earnings, and the Group Management Report, the Supervisory Board approved the financial statements prepared by the Managing Board without objection.

The Supervisory Board wishes to thank the Managing Board members and all employees worldwide for their outstanding commitment and constructive personal contributions to the company's success. We would also like to thank the Works Council for its valuable cooperation.

Ditzingen, October 2023

Dr.-Ing. E. h. Peter Leibinger
Chairman of the Supervisory Board

COMPANY INFORMATION

Managing Board

DR. PHIL. NICOLA LEIBINGER-KAMMÜLLER

Chief Executive Officer (CEO)

- Chairwoman of the Managing Board of TRUMPF SE + Co. KG
- Responsible for Corporate Communications, Public Policy & Brand, Corporate Development, Group Legal & Integrity, and Corporate Real Estate & Sustainability

DR.-ING. E. H. PETER LEIBINGER (to 06/30/2023)

Chief Technology Officer (CTO)

- Vice Chairman of the Managing Board of TRUMPF SE + Co. KG
- Responsible for Corporate Technology & New Business, the areas of EUV and Venture Capital, and for developing new business fields

DR. RER. POL. LARS GRÜNERT

Chief Financial Officer (CFO)

- Member of the Managing Board of TRUMPF SE + Co. KG
- Responsible for Group Finance & Controlling and Internal Risk Management, Financial Services, and Treasury & Insurance

DR.-ING. MATHIAS KAMMÜLLER

Chief Digital Officer (CDO)

- Member of the Managing Board of TRUMPF SE + Co. KG
- Responsible for Corporate Business Information Services, Corporate Marketing, Sales & Services, and Corporate Operations

DIPL.-BETRIEBSW. OLIVER MAASSEN

Chief Human Resources Officer (CHRO)

- Member of the Managing Board of TRUMPF SE + Co. KG
- Responsible for Human Resources (Labor Director)

DR.-ING. STEPHAN MAYER

Chief Executive Officer Machine Tools (CEO MT)

- Member of the Managing Board of TRUMPF SE + Co. KG
- Responsible for national subsidiaries and regions

DR. RER. NAT. BERTHOLD SCHMIDT (from 07/01/2023)

Chief Technology Officer (CTO)

- Member of the Managing Board of TRUMPF SE + Co. KG
- Responsible for Corporate Technology & New Business, the areas of EUV, Electronics, Venture Capital, and Photonic Components, and for developing new business fields

DR.-ING. CHRISTIAN SCHMITZ (to 06/30/2023)

Chief Executive Officer Laser Technology (CEO LT)

- Member of the Managing Board of TRUMPF SE + Co. KG
- Responsible for national subsidiaries and regions

DR. RER. NAT. HAGEN ZIMER (from 07/01/2023)

Chief Executive Officer Laser Technology (CEO LT)

- Member of the Managing Board of TRUMPF SE + Co. KG
- Responsible for national subsidiaries and regions

Partners

LEIBINGER FAMILY

- 90.0 percent

BERTHOLD LEIBINGER STIFTUNG GMBH*

- 10.0 percent

* Indirectly via Berthold Leibinger Beteiligungen GmbH

** Supervisory Board of the Managing Partner of TRUMPF SE + Co. KG

*** Employee representative

Supervisory Board**

DR. RER. NAT. JÜRGEN HAMBRECHT (to 06/30/2023),

Neustadt a. d. Weinstraße

- Chairman of the Supervisory Board of Leibinger SE

DR.-ING. E. H. PETER LEIBINGER (from 07/01/2023),

Schwieberdingen

- Chairman of the Supervisory Board of Leibinger SE

RENATE LUKSA***, Vaihingen/Enz

Vice Chairwoman of the Supervisory Board of Leibinger SE

- Chairwoman of the Joint Works Council of TRUMPF Werkzeugmaschinen SE + Co. KG, Ditzingen

PROF. DR. RER. NAT. CLAUDIA ECKERT (to 06/30/2023),

Garching

- Professor of IT Security at the Technical University of Munich
- Director of the Fraunhofer Institute for Applied and Integrated Security (AISEC), Garching

DR.-ING./U. CAL. MARKUS FLIK, Stuttgart

- Industrial Advisor & Investor, Member of Supervisory and Advisory Boards

STEFAN FUCHS, Hirschberg

- Chairman of the Executive Board of FUCHS SE, Mannheim

ALEXANDER HASSELBÄCHER*** (from 10/01/2022),

Lahnau

- Second Authorized Representative of IG Metall Stuttgart, Stuttgart

DIRK HÖLSCH***, Oberndorf a. N.

- Chairman of the Works Council of TRUMPF Laser GmbH, Schramberg

PROF. REGINE LEIBINGER, Berlin

- Managing Director and Partner Barkow Leibinger Architekten, Berlin

JAN LINDEMANN***, Freiburg

- Head of Global Engineering Electronics, TRUMPF Hüttinger GmbH + Co. KG, Freiburg

YVONNE MÖLLER***, Stuttgart

- Union Secretary of IG Metall, Baden-Württemberg, Stuttgart

RAINER NESKE, Frankfurt

- CEO of Landesbank Baden-Württemberg, Stuttgart

ELKE REICHART (from 07/01/2023), Ammerbuch

- Former Chief Digital Officer (CDO) of TUI AG, Member of Supervisory and Advisory Boards

MARTIN RÖLL*** (to 09/30/2022), Tübingen

- Second Authorized Representative of IG Metall Stuttgart, Stuttgart

HARALD WEIHBRECHT-BETZ***, Trochtelfingen

- Head of Production Unit Assembly Modules, TRUMPF Werkzeugmaschinen SE + Co. KG, Hettingen

LOCATIONS IN GERMANY



- Ditzingen (headquarters)
- Gerlingen
- Herzogenrath
- Teningen
- Hettingen
- Aachen
- Neukirch
- Ulm
- Berlin
- Schramberg
- Unterföhring
- Freiburg
- Stutensee
- Stuttgart

Selected locations of legally independent and dependent companies.

LOCATIONS IN EUROPE

(excluding Germany)

29



- Sofia, Bulgaria
- Haguenau, France
- Paris, France
- Luton, United Kingdom
- Southampton, United Kingdom
- Dublin, Ireland
- Milan, Italy
- Turin, Italy
- Vicenza, Italy
- Zagreb, Croatia
- Eindhoven, Netherlands
- Hengelo, Netherlands
- Spankeren, Netherlands
- Pasching, Austria
- Warsaw, Poland
- Zielonka, Poland
- Lisbon, Portugal
- Bucharest, Romania
- Moscow, Russia
- Alingsås, Sweden
- Baar, Switzerland
- Grüşch, Switzerland
- Košice, Slovakia
- Madrid, Spain
- Vitoria-Gasteiz, Spain
- Liberec, Czech Republic
- Prague, Czech Republic
- Istanbul, Türkiye
- Budapest, Hungary

Selected locations of legally independent and dependent companies.

LOCATIONS WORLDWIDE

(excluding Europe)



28

AMERICAS

- São Paulo, Brazil
- Mississauga, Canada
- Apodaca, Mexico
- Querétaro, Mexico
- Chicago, IL, US
- Costa Mesa, CA, US
- Cranbury, NJ, US
- Detroit, MI, US
- Farmington, CT, US
- Santa Clara, CA, US
- Wilmington, DE, US

ASIA-PACIFIC

- Dongguan, China
- Beijing, China
- Shanghai, China
- Shenzhen, China
- Taicang, China
- Yangzhou, China
- Chennai, India
- Pune, India
- Jakarta, Indonesia
- Yokohama, Japan
- Kuala Lumpur, Malaysia
- Manila, Philippines
- Singapore, Rep. Singapore
- Seoul, South Korea
- Taoyuan City, Taiwan
- Bangkok, Thailand
- Ho Chi Minh City, Vietnam

EMPLOYEES BY REGION

TOTAL

18,352

plus 10.9%

GERMANY

9,124

plus 8.4%

AMERICAS

1,683

plus 9.2%

TOTAL EXCLUDING GERMANY

9,228

plus 13.4%

EUROPE
EXCLUDING GERMANY

5,048

plus 19.6%

ASIA-PACIFIC

2,497

plus 5.0%

Figures as of June 30, 2023/Percentage change year on year.

SALES REVENUES BY REGION

in million euros

TOTAL

5,365

plus 27.0%

GERMANY

779

plus 32.2%

AMERICAS*

1,161

plus 42.8%

COOPERATIONS
(EUV BUSINESS)

971

plus 22.2%

TOTAL EXCLUDING GERMANY

4,586

plus 26.2%

EUROPE
EXCLUDING GERMANY*

1,280

plus 26.4%

ASIA-PACIFIC*

1,159

plus 16.0%

Figures as of June 30, 2023/Percentage change year on year.

*We conducted our EUV business almost exclusively in the Netherlands as this is where our customer ASML has its headquarters. As this distorts the regional view, sales revenues in the regions are shown adjusted for the share attributable to EUV.

TRUMPF GROUP KEY FIGURES

	2021/22	2022/23	Change from 2021/22 in percent
SALES REVENUES in million euros	4,222.8	5,364.5	+27.0
ORDER INTAKE in million euros	5,577.4	5,088.0	-8.8
EBIT in million euros	468.4	615.4	+31.4
EBIT MARGIN in percent	11.1	11.5	+3.4
INVESTMENTS in million euros	218.2	315.7	+44.7
RESEARCH AND DEVELOPMENT COSTS in million euros	448.0	476.3	+6.3
BALANCE SHEET TOTAL in million euros	4,586.1	5,019.1	+9.4
EQUITY in million euros	2,387.1	2,700.4	+13.1
EQUITY RATIO in percent	52.1	53.8	+3.3
ECONOMIC EQUITY* in million euros	2,500.1	2,709.9	+8.4
ECONOMIC EQUITY RATIO in percent	54.5	54.0	-0.9
EMPLOYEES ON JUNE 30 number	16,554	18,352	+10.9

*Equity capital plus long-term loans from partners

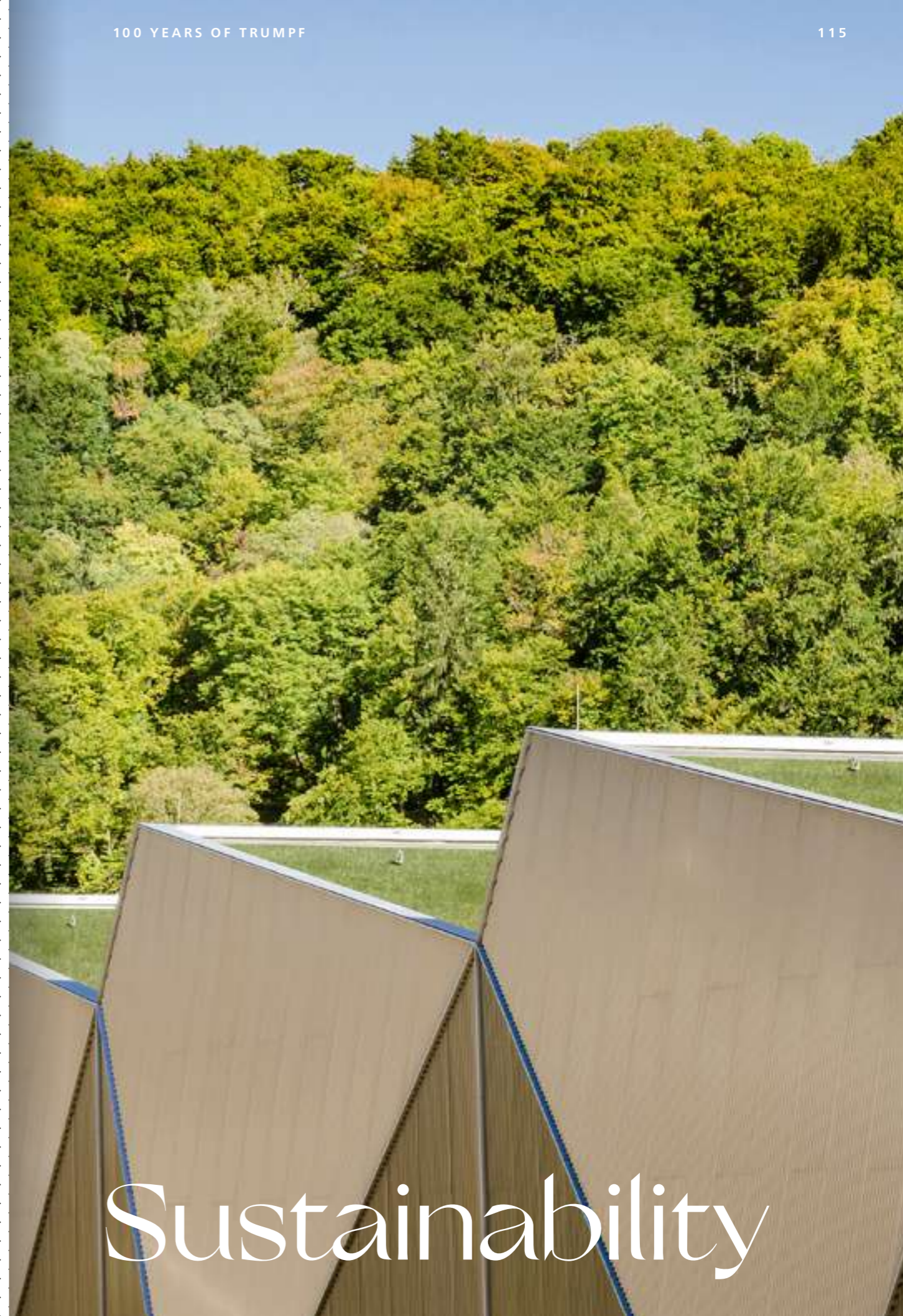

Sustainability

Success is born of entrepreneurial courage and the joy of innovation. But also responsibility.

Besides a fascination for technology, one hundred years of success is only possible through farsightedness and responsible action – through sustainable decisions for the benefit of future generations. Acting accordingly with regard to people and the environment has therefore always been a natural part of TRUMPF’s company history. It can be seen in many examples from the past as well as in our ambitious climate strategy for the future. Identifying technological ways of conserving resources has become one of our core areas of action.

TRUMPF’s climate strategy

TRUMPF has made a commitment to the Paris Agreement’s 1.5 °C target and is reducing its emissions accordingly. In concrete terms, this means that by 2030, there should be 55 percent fewer emissions from TRUMPF locations and the vehicle fleet (Scopes 1+2) and 14 percent fewer emissions in the upstream and downstream value chains (Scope 3) – in each case compared to 2019. In view of TRUMPF’s strong growth, these goals are a challenge that requires particular attention. For this reason, TRUMPF has included sustainability in its long-term TRUMPF strategy in fiscal year 2022/23.

At our locations, TRUMPF has been achieving success for years through ambitious projects for greater energy efficiency. In this area, the company has outperformed the emissions targets set for this year. In the upstream and downstream value chain (Scope 3), projects are underway to reduce emissions in areas such as product development and purchasing. However, the measures will only have a visible impact in the coming fiscal years, as their implementation will take place over a longer period of time.

	Emissions 2018/19	Emissions 2022/23	Change
Scopes 1+2: Locations			
Market-based	45,148*	25,915	- 43%
Location-based	83,895*	86,229	3%
Scope 3.1: Purchased goods and services	790,103*	1,074,898	36%
Scope 3.11: Use of sold products	5,677,223*	5,546,006**	- 2%**
Other Scope 3: Transportation, investments, commuting, business travel	168,117	353,342	110%

*Baseline recalculation of Scopes 1, 2 and 3.1 due to better data availability and alignment of emission factors. Recalculation of Scope 3.11 to follow in fiscal year 2023/24.

**Preliminary

Note: Scope 1+2 energy consumption in 2022/23: 273,510.3 MWh

Efficiency & elegance

HOW TRUMPF IS COMBINING ARCHITECTURE WITH CLEVER ENERGY CONCEPTS

TRUMPF buildings are imposing and sustainable. Hidden inside are ingenious energy concepts.



1a / Ditzingen

When constructing the first office building at its headquarters in Ditzingen, TRUMPF placed particular emphasis on good lighting and ventilation for all workstations, modern recreation rooms, air conditioning and good building materials. (1972)



1b / Ditzingen

When commissioning machines, TRUMPF relies on automatic shutdowns and provides cooling water for lasers as needed, for example. The elaborate project resulted in particularly significant savings. (2016ff.)



1c / Ditzingen

At its headquarters, TRUMPF uses waste heat from chillers to heat buildings via heat pumps. This generates around 750 MWh of thermal energy at the location. TRUMPF is implementing similar projects all over the world. (2022)



2 / Schramberg

During endurance tests of power electronic assemblies, TRUMPF feeds a large portion of the energy used back into the power grid instead of releasing it into the environment as heat. This saves 282 MWh annually. (2019)



3 / Hettingen

Since the expansion of the Hettingen location, TRUMPF has been using water from the nearby River Lauchert to cool its buildings and machines. Chillers are now only used for peak loads. (2016)



4 / Liberec

TRUMPF is steadily replacing light bulbs with LED lamps. Liberec is one of the first factories to be converted. Converting to LED saves TRUMPF a total of around 2000 MWh per year compared to conventional light sources. (2019)



5 / Pasching

TRUMPF brings the building at the Pasching location to the right temperature with the help of concrete core activation. This creates a pleasant indoor climate and keeps energy consumption low. (2015)



6 / Taicang

In Taicang, TRUMPF uses a heat pump combined with geothermal energy for heating. As a result, the location is heated entirely without fossil fuels. This together with green electricity means that operations are entirely carbon neutral. (2018)



7 / Apodaca

The Apodaca location has many photovoltaic systems and can be completely self-sufficient in electricity thanks to the good conditions. (2021)

Technology & design

HOW TRUMPF IS MAKING ITS PRODUCTS MORE SUSTAINABLE

TRUMPF products combine aesthetic appeal and technical excellence. Even the very first TRUMPF products are characterized by their quality and ease of use. In recent decades, the focus has increasingly shifted to the economical use of energy and resources.

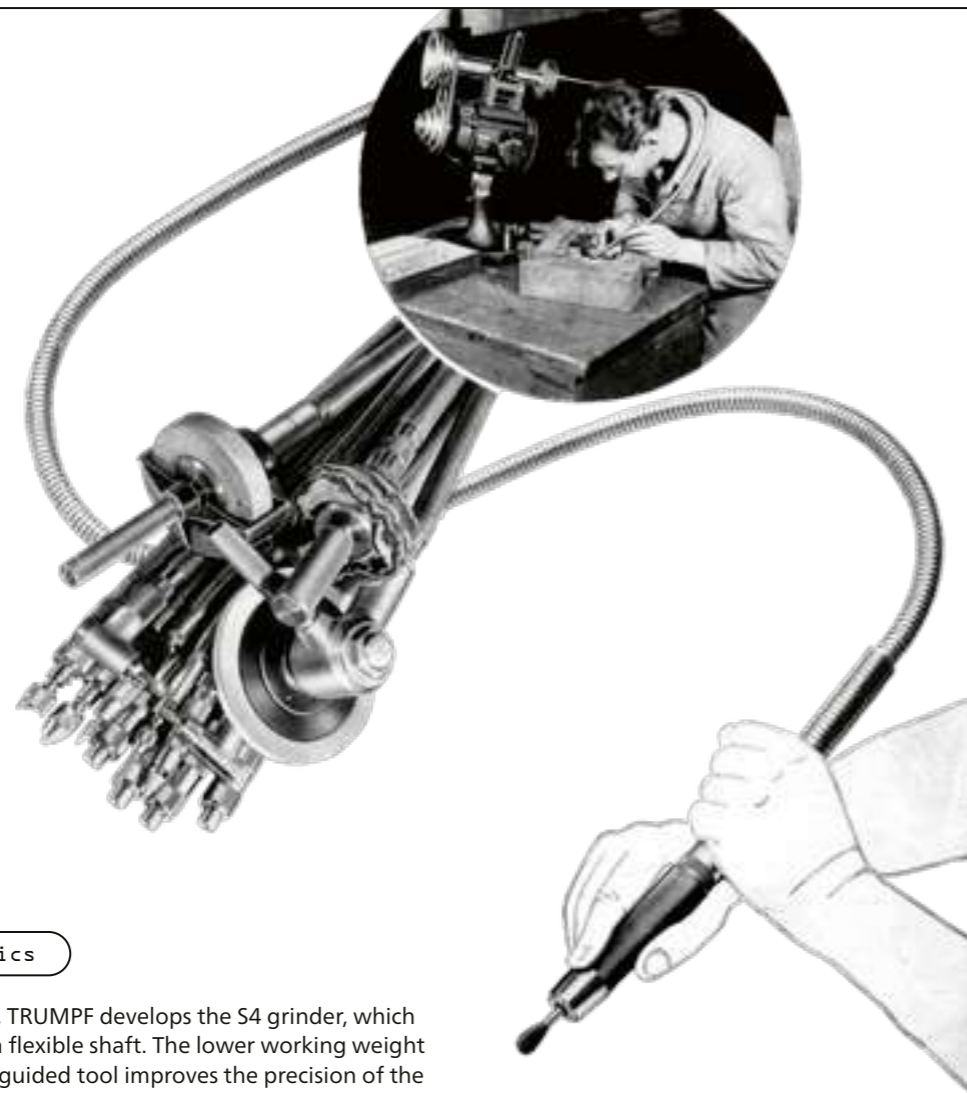

Ergonomics

In the 1930s, TRUMPF develops the S4 grinder, which is driven by a flexible shaft. The lower working weight of the hand-guided tool improves the precision of the grinding results and protects the operator's health in the long term. To this day, good ergonomics and maximum product safety are second nature to TRUMPF.



Efficiency in laser cutting

Today, customers can do their laser cutting with a fraction of the energy required in 2009. This is due to several innovations at once: Compared to CO₂ lasers, solid-state lasers are more efficient, and the shorter wavelength also couples better into the steel sheet. At the same time, the "Highspeed Eco" add-on function ensures that a large proportion of cutting gas can be saved. As a result, laser cutting now consumes 70 percent less energy.

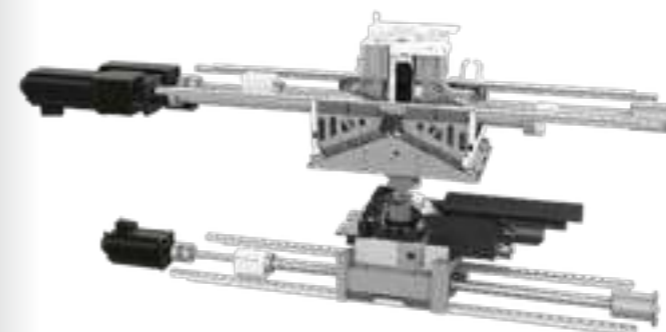

Delta Drive

The patented drive works electrically. A machine with Delta Drive requires around 20 percent less energy than a machine with a hydraulic punching head.

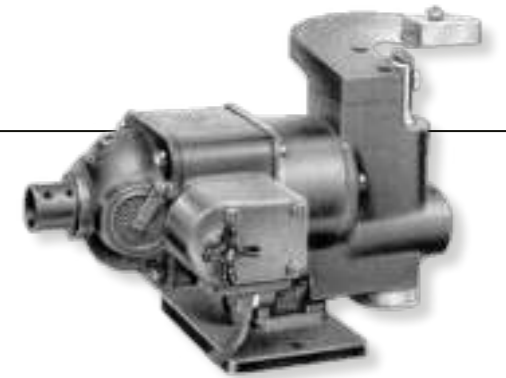

Durability

This OMS 4 sheet metal cutter has been in use for about 80 years, from the late 1930s to 2019. Its long service life is due to good product quality, excellent service and mindful use by customers. Extended use is the norm for TRUMPF products. Around 70 percent of the machines change hands during their lifetime and then continue to function for ten years or more. TRUMPF makes sure that its products provide lasting service and has also been certifying partners who recondition machines for many years.



BrightLine Speed

In 3D laser cutting, the BrightLine Speed add-on function provides 60 percent more cutting speed with 50 percent less cutting gas consumption. Taken together, this reduces energy consumption per part by 15-20 percent.

Vision of the future & audacity

HOW SOLUTIONS FROM TRUMPF ARE HELPING SHAPE
THE TECHNOLOGIES OF TOMORROW

TRUMPF solutions are important drivers of success in the major
emerging industries of energy, sustainable mobility and digitalization.

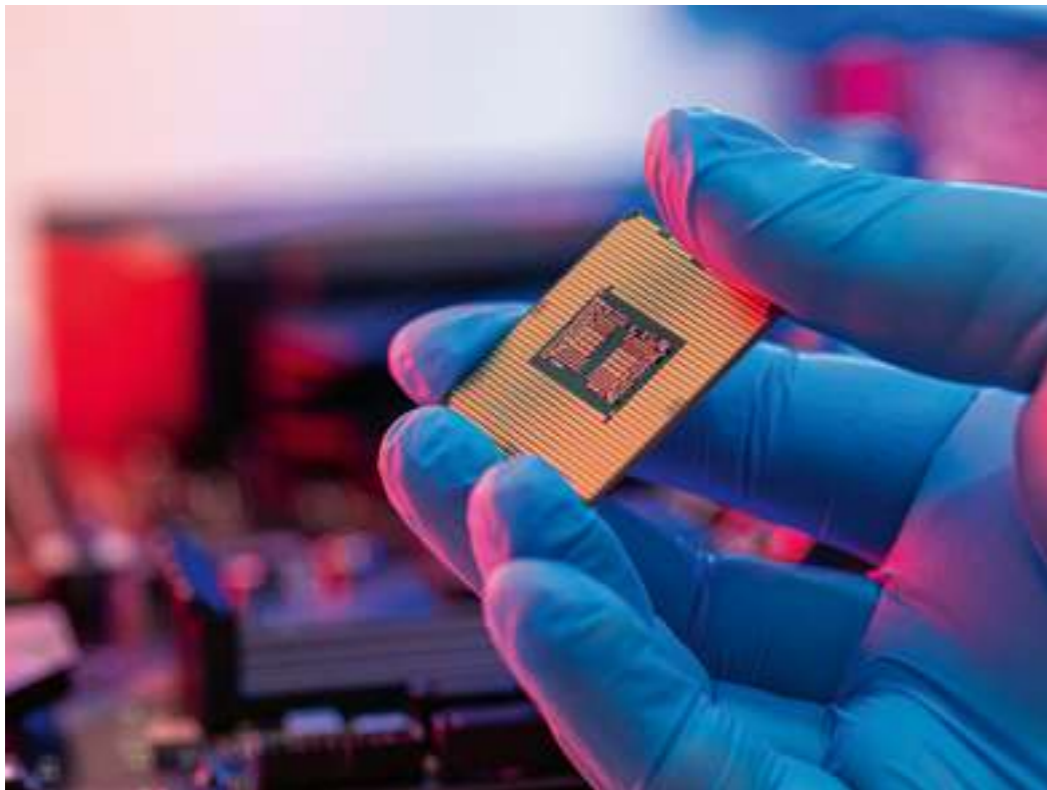

Chips of the future

The most powerful pulsed industrial laser in the world ever shoots at 50,000 tin droplets per second twice. EUV lithography is not only a unique technical feat, but the basis for the most advanced generation of semiconductors. These microchips produced with EUV have ultra-high computing power and enable artificial intelligence, automotive and 5G applications.

Photonics

Vertical cavity surface-emitting lasers (VCSELs) and photodiodes help meet the ever-increasing demand for data transmission on the internet and in supercomputers. They keep energy consumption low: with VCSELs, many times more data can be transmitted over optical fibers with only a fraction of the energy required by copper cables.



Photovoltaics

In recent years, TRUMPF's Electronics business division has helped make photovoltaics increasingly powerful and competitive. Generators improve the coatings of solar panels and consequently their efficiency. Battery inverters efficiently store the recovered energy and then release it.



Electromobility

Electric cars cannot be produced economically without lasers. The laser welds the battery cells and joins them together to form modules or packs. It ensures crash-proof battery trays, welds copper connections and is used in the production of electric motors. Laser diodes from TRUMPF also ensure greater sustainability in e-mobility. When used to dry battery foils, they save energy and space in production compared to the ovens that would otherwise be used.

AROUND

10 million

E-CARS WILL BE MANUFACTURED IN 2023 WITH THE HELP OF TRUMPF TECHNOLOGY.

Ingenuity & experience

HOW THE USE OF TRUMPF SOLUTIONS MAKES OUR CUSTOMERS' PRODUCTS MORE SUSTAINABLE

With 100 years of expertise in sheet metal processing, TRUMPF has an intimate understanding of its customers' challenges and requirements. TRUMPF solutions make these customers' end products much more sustainable.



Tailor-welded blanks

Since the 1990s, lasers have enabled the automotive industry to weld or cut body components of various thicknesses. This has resulted in a significant contribution to lightweight construction and lower fuel consumption.

THE USE OF TRUMPF TECHNOLOGIES CAN SAVE UP TO

70 PERCENT

CO₂ PER PART.

Hot forming

In the late 2000s, high-strength steel in the automotive industry ensures maximum stability despite thin and therefore lightweight material. The laser is the only tool capable of cutting the required material quickly, without burrs or wear. This paves the way for the widespread use of high-strength steels in vehicles, for example in B-pillars.



Part design

Since the late 1990s, TRUMPF and its team of design and technology experts have been advising customers on the sustainable design of sheet metal structures. The carbon footprint of a sheet metal assembly can easily be reduced by up to 70 percent compared to conventional milled or welded designs and is still associated with significantly lower manufacturing costs. Recently, TRUMPF subsidiary Optimate also began offering AI-supported software that automatically detects the potential for improvement in a sheet metal structure.



Active Speed Control

The "Active Speed Control" add-on function continuously monitors the laser cutting process, automatically regulates the feed rate and gets the best out of the sheet metal depending on its quality and thickness. This ensures high process reliability and saves material.

Trust & responsibility

HOW TRUMPF IS SHAPING THE WORKING ENVIRONMENT AND MAKING AN IMPACT ON SOCIETY

At TRUMPF, it goes without saying that a company can only be as good as its employees. This is why good working conditions and training have always played a major role.



Training

At TRUMPF, responsibility for the next generation has always been part of the equation: with apprenticeships and dual studies in Germany and similar programs in the US, China, France, Czechia and India. The number of people learning a trade at TRUMPF is increasing every year – most recently to 550 in Germany alone.



Education and research

We see education and research as an unshakable foundation for technological progress and innovation. As a research-intensive company, we also take this responsibility seriously and support various education and research projects. This pillar of our success is also reflected in our day-to-day business. For example, TRUMPF has a very high R&D ratio of 8.9 percent measured against sales revenues.

Art and culture

As a culture-loving company, we want to create an inspiring general working environment by promoting cultural and artistic projects. In doing so, we increase the attractiveness of our locations for our employees as well as for the general public. We have been supporting art and cultural projects for many years – locally, regionally and internationally. For example, our location in the UK sponsors the Hastings Philharmonic Orchestra and TRUMPF Switzerland supports the Kulturhaus Rosengarten in Grüşch. This is our way of bringing art to life, both inside and outside the company.



Alliance for Work

In 2011, TRUMPF introduces a pioneering working time model in Germany: employees can choose their own working hours, making them more compatible with their respective life situations. In this way, TRUMPF is setting a new standard for the entire industry and consolidating its reputation as an outstanding employer.



Engagement in social issues

TRUMPF supports social and charitable organizations worldwide. The company is committed to social values and equal opportunities. It supports a large number of collaborative partnerships and local projects. These include bhz, a Stuttgart-based institution offering support to disabled people, and the Apla Ghar NGO in Pune, India, which supports an orphanage, a vocational training institute for schoolchildren and a hospital, for example. This enables us to help socially disadvantaged people participate in society and to promote a change of perspective in our workforce.



Group Management Report

Group Management Report

for fiscal year 2022/23

Structure and Business Activities

Laser Technology and Machine Tools – our portfolio

Machine tools for flexible sheet metal and tube processing represent our largest area of activity. Our product range includes machines for bending, punching, and combined punch-laser processes as well as for laser cutting and laser welding applications. Diverse automation solutions and a wide range of software for networked manufacturing solutions round off the portfolio.

Our product range in laser technology includes laser systems for cutting, welding, surface treatment of three-dimensional parts, and marking lasers and systems. We offer high-performance CO₂ lasers, disk and fiber lasers, diode lasers, and ultrashort pulse lasers.

The Electronics business field is part of Laser Technology, and includes products with direct-current, high-frequency and medium-frequency generators for inductive material heating, surface coating, and processing using plasma technology, as well as for laser excitation.

3D printing systems for metallic components and medical implants are also included in our portfolio. As part of our additive manufacturing activities in this area, we use the two relevant technologies of laser metal fusion and laser metal deposition.

CO₂ lasers for EUV lithography constitute another business field, which involves using extreme ultraviolet radiation to produce even smaller, more efficient circuits and microchips.

In addition to the existing business with high-performance diode lasers, laser diodes from the Photonic Components business field are used in smartphones, digital data transmission, and sensors for autonomous driving.

Organizational structure

The holding company TRUMPF SE + Co. KG is the organizational umbrella under which the TRUMPF Group operates. Operational responsibility for the business divisions and business fields is divided among various members of the Managing Board.

The TRUMPF Group's operating business is mainly organized in the two business divisions Machine Tools and Laser Technology. Within these business divisions, individual product and market segments are managed as

separate business fields. This is the case, for example, with our Chinese machine tools brand JFY in the Machine Tools division, and with Electronics in the Laser Technology division.

The Machine Tools and Laser Technology business divisions are managed by a divisional management team. The managing directors or CEOs of each business division are supported by a management team whose members are responsible for different functions of the value chain: research and development, production, sales and service, finance and human resources. The two business division heads are also members of the management holding company's Managing Board.

Alongside its two business divisions, TRUMPF manages its activities in the areas of EUV, Photonic Components and Financial Services in separate business fields. These are led by separate management teams, each of which reports directly to a member of the Managing Board.

Global presence – close to our customers

The TRUMPF Group is present in all its major markets worldwide. We have 87 operating subsidiaries in Europe, the Americas, and the Asia-Pacific region. We have industrial production facilities in Europe (Austria, Czech Republic, France, Germany, Italy, Poland, Switzerland, and the United Kingdom), on the American continent (US and Mexico), and in China. In addition, we carry out software development at our locations in Germany, Spain and India.

Our headquarters are located in Ditzingen, Germany.

We support our customers with comprehensive services covering the entire life cycle of our products. We offer a full range of services – from financing, tools and spare parts, technical service, consulting and training through to functional upgrades, process optimization concepts, monitoring and analytical tools, and trade in pre-owned machinery.

Financial Management of the TRUMPF Group

Business divisions and business fields

The TRUMPF Group uses divisional accounting to reflect its division-oriented organizational structure from a business management perspective.

As a result, all sales revenues and costs of the individual legal entities are allocated to the business divisions and business fields bearing global management responsibility for these, regardless of the legal structure.

Functional management responsibility

At TRUMPF, the consolidated profit and loss statement is prepared using the cost-of-sales method. This provides business support to the divisional management teams in exercising their functional management responsibility. The cost of goods sold and the cost of sales, research and development, and administration are presented transparently in the profit and loss statement.

Sustainable value growth

The ultimate business objective of the TRUMPF Group is to continuously increase the value of the company by generating lasting positive value added.

Value added by the TRUMPF Group is defined as the operating result before interest and taxes (EBIT – earnings before interest and tax) minus the cost of capital of the operationally invested capital.

The cost of capital is defined as the minimum rate of return on the average invested capital. The minimum rate of return (WACC – weighted average cost of capital) for fiscal year 2022/23 of 9.5 percent (previous year: 9.5 percent) is before taxes and is derived from a representative peer group of companies from the business divisions and business fields. The WACC is reviewed regularly.

At TRUMPF, the ultimate business objective of continuously increasing the value of the company is broken down into three operational objectives:

- (1) High growth
- (2) Adequate profitability
- (3) Efficient capital employed

in k€	2022/23	2021/22
(1) High growth		
Sales revenues	5,364,513	4,222,768
<i>Growth compared to previous year</i>	27.0 %	20.5 %
(2) Adequate profitability		
Earnings before taxes	608,605	409,502
+ Financial and investment result	8,896	63,831
- Exchange rate gains of the net financial position ¹	-1,898	-5,012
-/+ Other financial income and financial expenses	-248	107
= EBIT	615,355	468,428
<i>as a % of sales revenues</i>	11.5 %	11.1 %
(3) Efficient capital employed		
Intangible assets	81,565	127,826
+ Tangible assets	1,608,750	1,433,528
Operating fixed assets	1,690,315	1,561,354
Trade receivables	1,089,859	844,809
+ Inventories	1,437,218	1,255,346
- Down payments received	-386,086	-457,847
- Trade payables	-447,677	-420,367
+ Working capital	1,693,314	1,221,941
= Invested capital (reporting date June 30)	3,383,629	2,783,295
<i>as a % of sales revenues (of the previous 12 months)</i>	63.1 %	65.9 %
Invested capital (average²)	3,147,081	2,593,285
Value added		
Invested capital (average ²)	3,147,081	2,593,285
x WACC (before taxes)	9.5 %	9.5 %
= Cost of capital	298,973	246,362
EBIT	615,355	468,428
- Cost of capital	-298,973	-246,362
= Value added	316,382	222,066

¹Included in other operating income and other operating expenses

²Average over the 12 months of the fiscal year

Financial independence

The TRUMPF Group is a family-run company. The family's aim is to manage TRUMPF in a way that is autonomous over the long term and independent of external investors.

For this reason, the company plans to achieve its sustainably high growth objective on an organic basis as far as possible. The investments required for this are generally to be financed by TRUMPF's operating cash flow in order to generate a positive free cash flow.

In turn, this positive free cash flow is used to strengthen the company's net financial position. A strong net financial position enables TRUMPF to finance even substantial individual investments, such as corporate acquisitions, from its own resources.

Likewise, maintaining a high equity ratio guarantees the company's economic independence. Economic equity, which includes long-term liabilities to partners, serves as an additional key figure.

in k€	2022/23	2021/22
Cash inflow from operating activities	305,669	430,923
- Cash outflow from investing activities (operating)	-389,340	-218,649
= Free cash flow	-83,671	212,274
Cash and cash equivalents, securities	648,717	803,159
+ Other financial receivables*	-	10,550
+ Medium-term financial investments	105,787	232,101
- Financial liabilities	-410,338	-319,149
= Net financial position	344,166	726,661
Equity	2,700,399	2,387,106
<i>as a % of the balance sheet total</i>	53.8 %	52.1 %
+ Long-term liabilities to partners (> 1 year)	9,511	113,029
= Economic equity	2,709,910	2,500,135
<i>as a % of the balance sheet total</i>	54.0 %	54.5 %

* From FY 2022/23, other financial receivables will no longer be included in the net financial position. Comparability with the previous year is therefore limited.

Economic Report

Economic environment

Change in gross domestic product in percent

Compared to 2021, global growth slowed down in 2022.

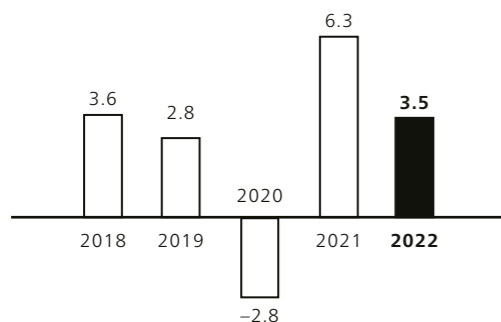

Source: International Monetary Fund

Inflation, rising interest rates and high energy prices dominate global economic development

Fiscal year 2022/23 was characterized by the recovery of supply chains and improved delivery times, while persistently high inflation and key interest rate hikes by central banks impacted economic performance. The hoped-for recovery in global economic development due to the end of the coronavirus pandemic in 2022 was halted by rising interest rates, high energy prices and the Russian war of aggression against Ukraine. These factors continued to impact global growth in the second half of the fiscal year.

According to IMF figures, the global economy grew by 3.5 percent in 2022 overall. The IMF expects an increase of 3.0 percent for 2023 as a whole. Compared with the rest of the world, economic output in the industrialized countries grew by just 2.7 percent in 2022, compared with 5.4 percent in the previous year. The IMF calculated slightly stronger growth of 3.5 percent for the eurozone. At 1.8 percent, Germany was among the countries with lower growth compared with the eurozone average. For 2023, the growth expectation is only 0.9 percent, with a decline of 0.3 percent forecast for Germany.

The US, on the other hand, grew by 2.1 percent in 2022, below the average for the industrialized countries; growth of 1.8 percent is expected for 2023. At 1.0 percent, growth in Japan was at the lower end of the industrialized countries in 2022, similarly to Germany, and is expected to increase slightly to 1.4 percent in 2023.

The emerging economies also saw their growth rate weaken in 2022, averaging 4.0 percent. China's economy expanded by only 3.0 percent in 2022, following strong 8.4 percent growth in the previous year. The economies of Brazil and Mexico also grew less strongly than in the previous year, by 2.9 percent and 3.0 percent respectively. India, on the other hand, continued to record high growth of 7.2 percent. For 2023, the IMF expects the growth rate in the emerging markets to remain constant at an average of 4.0 percent.

While energy and food prices stabilized in most countries, the tightening of monetary policy in the first half of 2023 had a destabilizing effect on the financial markets. Turmoil among banks, as recently seen in the US and Switzerland, added to the uncertainty but remained local in its impact for the time being. Russia's ongoing war in Ukraine and restrained consumer spending in China also remain key factors in the global economic growth trend.

Weaker order intake in machinery and plant engineering

The machinery and plant engineering sector proved its resilience in 2022 thanks to solid order backlogs. As supply bottlenecks eased, the global machinery industry increased its sales revenues by 12 percent year-on-year to 3,385 billion euros. Of note in this context are exchange rate and price increase effects, which meant that sales revenues grew by only 2 percent on a pure volume basis. Despite the easing of supply chain problems, the German Mechanical Engineering Industry Association (VDMA) believes that 2023 will continue to be fraught with uncertainty – primarily due to the weakening order intake in the first few months of the calendar year. For this reason, the VDMA is forecasting only price-adjusted growth in revenues of one percent for 2023.

Laser technology market stagnates despite growth in electromobility

Based on a study by Optech Consulting, the overall market for industrial laser systems in 2022 was unable to sustain the strong 25.0 percent growth of the previous year and stagnated at a market volume of 22 billion US dollars. Here, too, the industry is suffering from currency exchange effects – while demand grew in local currencies, the market failed to grow in dollar terms. Market development in 2022 was characterized primarily by opposing regional trends, with robust demand in the Americas and a simultaneous decline in demand in China. By application area, electromobility and semiconductor manufacturing continued to deliver impressive growth.

Optech Consulting forecasts that the overall market for industrial laser systems will grow between 5 and 10 percent in 2023. North America in particular is seen as a growth driver.

Business Development

Sales revenues and earnings reached record levels despite difficult conditions

In the past fiscal year, TRUMPF again exceeded the 5 billion mark for its order intake, but fell short of the all-time high from the previous year. For the fiscal year as a whole, the TRUMPF Group's order intake of 5,088 million euros was 8.8 percent below the previous year's figure of 5,577 million euros. As a result, we were not quite able to achieve the forecast, which had envisioned a similarly high order intake level.

Sales revenues, on the other hand, rose sharply in the past year: by 27.0 percent to a new high of 5,365 million euros (previous year: 4,223 million euros). The strong growth was due, among other things, to a significant reduction in supply chain problems and the high order backlog from the previous year, which we were able to work off to a greater extent than expected. The forecast growth in revenues was significantly exceeded. Our book-to-bill ratio, the ratio of order intake to sales revenues, was 0.95, a significant reduction compared with the previous year (1.32).

At 615 million euros, EBIT was significantly higher than the previous year (468 million euros). The earnings increase was driven in particular by strong growth in revenues. We were therefore able to achieve the expected EBIT from the forecast. Last year's solid level of returns was again slightly exceeded, with the EBIT margin rising from 11.1 percent to 11.5 percent. The forecast EBIT margin was consequently also achieved. Particularly in view of the still very uncertain economic environment, we are very satisfied overall with the margin achieved.

We again generated clearly positive value added of 316 million euros in the past fiscal year. EBIT growth was significantly higher than growth in the average cost of capital, so value added increased by 94 million euros compared with the previous year (222 million euros). The forecast increase in value added was therefore achieved.

Overall, we largely met our forecasts for the year under review. While our sales revenue targets were significantly exceeded, order intake was below expectations. EBIT, EBIT margin, and value added were all in line with forecasts.

Order intake in million euros

The order intake was below the record of the previous fiscal year, but still exceeded the 5 billion mark.

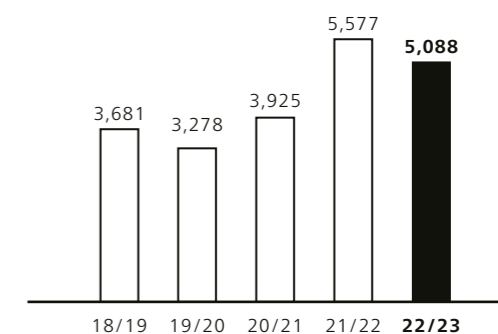

Order intake trend:

–8.8%

Order intake fell short of the previous year's record level

At 5,088 million euros, the order intake fell 8.8 percent short of the previous year's all-time high (5,577 million euros). Performance varied among the business divisions and business fields. Following the strong previous year, the Machine Tool business division had already anticipated a decline in order intake in its forecast. However, at 2,818 million euros, the decline compared to the previous year (–9.0 percent) was less severe than expected. The Laser Technology business division, on the other hand, achieved the forecast growth in order intake and, at 2,080 million euros, was 14.0 percent up on the previous year (1,824 million euros). This was primarily due to continued strong growth in the Electronics business field. The EUV business field recorded a significant decline in orders in the past fiscal year. At 809 million euros, the order intake was 23.5 percent below the record figure of the previous year (1,057 million euros) and also significantly below the forecast.

The order backlog decreased by 276 million euros in the past fiscal year, but at 2,504 million euros is still at a very high level (previous year: 2,780 million euros).

Sales revenues in million euros

Sales reached a new all-time high in the fiscal year 2022/23.

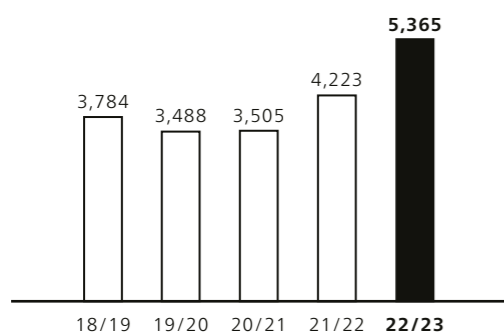

Sales trend:

+27.0%

Sales revenues rose sharply and reached a new all-time high

TRUMPF recorded strong growth in revenues in the past fiscal year. This was largely driven by significantly reduced supply chain bottlenecks and the high order backlog from the previous year, which we were able to work off to a greater extent than expected. Sales revenues increased by 27.0 percent from 4,223 million euros to 5,365 million euros, reaching a new historic high in the year of the company's 100th anniversary.

Sales revenues in our Machine Tools business division increased by a strong 32.8 percent to 3,038 million euros (previous year: 2,289 million euros). In the past fiscal year, the business division was able to derive particularly significant benefit from fewer problems in the supply chain, which in combination with the high order backlog led to the strong growth in revenues. As a result, the business division also clearly exceeded the growth anticipated in the forecast.

At 2,059 million euros (+28.0 percent; previous year: 1,609 million euros), the Laser Technology business division also achieved high growth in revenues compared to the previous year. Forecast sales revenues were also exceeded. Laser Technology benefited from continued strong growth in the electronics business and in the electromobility sector.

The EUV business again recorded strong growth in revenues. Driven by the sharp increase in order intake in the previous year, sales revenues in the current fiscal year rose by 22.2 percent to 971 million euros (previous year: 795 million euros). As a result, the ambitious sales revenues forecast was achieved.

Significant supply relationships exist between the business divisions and business fields. These sales revenues are consolidated across the TRUMPF Group.

Significant growth in revenues in all regions

We conduct our EUV business almost exclusively in the Netherlands as this is where our customer ASML has its headquarters. As this distorts the regional view, the following comments on sales development by region do not include sales revenues from the EUV business as a cooperation.

Sales revenues by region and cooperation

in million euros	2022/23	2021/22
Total	5,365	4,223
Germany	779	589
Europe (excluding Germany)	1,280	1,013
Americas	1,161	813
Asia-Pacific	1,159	1,000
Other	15	13
Cooperations (EUV business)	971	795

In our home market of Germany, we significantly grew sales revenues in the past fiscal year, recording an increase of 32.2 percent to 779 million euros (previous year: 589 million euros). Following the rather restrained growth in the previous year, this development is very encouraging. The growth rate was above the Group average; only in the Americas was growth even higher.

The markets in the rest of Europe also recorded double-digit growth on average. The major Western European markets of Italy (+46.9 percent), France (+39.0 percent), Spain (+36.3 percent) and the United Kingdom (+20.5 percent) all posted very significant increases, while sales revenues in Austria stagnated (+0.9 percent). Following a slight decline in the previous year, sales revenues in our major Eastern European market, the Czech Republic, rose again very significantly (+40.6 percent). In Poland (+16.4 percent) and particularly in Hungary (+50.2 percent), we continued to achieve significant growth. Due to the ongoing war, sales revenues in Russia fell to a minimum (-91.2 percent), while sales revenues in Ukraine remained at a very low level. As a result, the cumulative share of Group sales revenues accounted for by both countries has now fallen to just 0.1 percent.

The American markets can look back on a particularly successful fiscal year. In the US, we maintained our strong growth from the previous year with sales revenues increasing by 38.5 percent to 899 million euros. In Mexico, we more than doubled our sales revenues (+160.4 percent); Canada, on the other hand, achieved only a slight increase (+5.4 percent). South America again saw strong growth – in

Brazil, our largest market there, sales revenues increased by 59.9 percent.

The Asian-Pacific markets also achieved double-digit growth overall. In China, our revenues increased to 602 million euros despite the continuing difficult economic conditions. However, at 4.7 percent growth in revenues, we fell short of the previous year's growth rate. In the other Asian-Pacific markets, on the other hand, we achieved significant overall growth. Growth was driven by the two largest markets, South Korea (+43.4 percent) and Japan (+29.7 percent). India again recorded impressive growth (+30.1 percent), while sales revenues in Taiwan declined (-10.1 percent).

Americas' share of sales revenues up, Asia-Pacific down

Germany's share of sales revenues increased slightly year-on-year to 14.5 percent (previous year: 13.9 percent). By contrast, the share of Europe excluding Germany remained virtually constant at 23.9 percent (previous year: 24.0 percent). The portion attributable to the American markets rose to 21.6 percent (previous year: 19.3 percent). Conversely, Asia-Pacific's share of sales revenues, at 21.6 percent, was down on the previous year (23.7 percent). The share of sales revenues accounted for by the EUV business in the past fiscal year was 18.1 percent (previous year: 18.8 percent).

Results of operations, net assets and financial position

EBIT

in million euros

The significant year-on-year increase in earnings was driven in particular by strong sales growth.

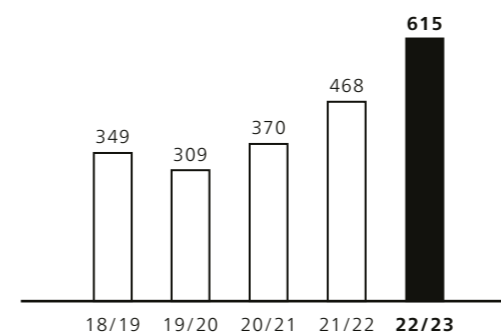

EBIT margin:

11.5%

Strong growth in revenues resulted in substantial increase in earnings

At 615 million euros, EBIT was significantly higher than the previous year (468 million euros). The earnings increase was driven in particular by robust growth in revenues. We thus exceeded the good level of returns achieved in the previous year. The EBIT margin rose from 11.1 percent in the previous year to 11.5 percent in the fiscal year under review.

The cost of goods sold includes all expenses attributable to products or services sold in the fiscal year as well as any remaining costs of the purchasing, production, and service operating areas that are not allocable to products or services. In line with our sales performance, the cost of goods sold was significantly higher than the previous year (2,556 million euros) at 3,353 million euros. The cost of sales ratio rose to 62.5 percent (previous year: 60.5 percent). The substantial increase is due to cost increases on the purchasing side. These mainly include inflation-related price adjustments by our suppliers and higher energy costs, which we did not pass on in full through price increases. Gross profit was 2,012 million euros (previous year: 1,667 million euros).

Sales costs include all personnel expenses allocated to the sales division, other operating costs (mainly travel and marketing costs), depreciation and amortization, and material costs for our showrooms. Freight and packaging costs are also included under this item to the extent that they can be allocated to transport from the production plant to the customer. The rise of 25.3 percent to 687 million euros is partly attributable to higher commission and freight costs due to higher sales. Personnel expenses also rose as a result of the expansion of the workforce and collectively agreed pay rises. Non-personnel costs also increased, in particular due to higher marketing, trade show and travel costs. The increase in non-personnel costs was due not only to volume but also to inflation. The sales costs to sales ratio remained virtually constant in fiscal year 2022/23 at 12.8 percent (previous year: 13.0 percent).

Research and development costs comprise all amounts spent on fundamental research and new developments and not related to current production. These include in particular personnel, non-personnel, and material costs, as well as depreciation and amortization. Research and development costs increased from 448 million euros to 476 million euros in fiscal year 2022/23. The main cost drivers were the expansion of the workforce and collectively agreed pay rises. At 8.9 percent, the research and development ratio was lower than in the previous year (10.6 percent). Historically, it remains at a high level.

General administrative costs include in particular personnel expenses, depreciation and amortization and other non-personnel costs relating to management,

IT, human resources, legal, corporate communications, infrastructure, and finance. Costs in the administrative area also increased significantly compared to the previous year, amounting to 281 million euros (previous year: 237 million euros). The increase was also due to the expansion of the workforce, collective pay increases and a significant rise in IT expenses. Preparations for the introduction of SAP S/4HANA were one reason for the higher IT expenses, along with an overall increase in the number of projects and inflation-related price adjustments by our suppliers. The administrative cost ratio remained virtually constant at 5.2 percent (previous year: 5.6 percent).

Other operating income (327 million euros, previous year: 267 million euros) and other operating expenses (277 million euros, previous year: 228 million euros) mainly comprised items that could not be allocated to specific functions as well as offsetting exchange rate gains and losses resulting from operating and financing transactions and the hedging of these transactions. The sharp increase in other operating income was mainly due to significantly higher exchange rate gains and the release of accruals. Furthermore, we also realized income of 28.5 million euros in the past fiscal year from insurance compensation for last year's plane crash at the Farmington site (US). Higher exchange rate losses and increased write-downs of receivables were the main drivers behind the significant increase in other operating expenses. Expenses from the plane crash in the previous year were still included in the amount of 6.2 million euros.

At -9 million euros, the financial and investment result was 55 million euros better than in the previous year (-64 million euros). Significantly lower interest expenses from accruals for pensions were the main reason for the significantly improved financial result. The valuation of the Contractual Trust Agreement investment resulted in a slight gain in the past fiscal year, compared with an exchange rate loss of 14 million euros in the previous year.

Taxes on income in fiscal year 2022/23 amounted to 147 million euros, 48 million euros higher than the previous year (99 million euros).

Overall, consolidated net income for the year was 462 million euros (previous year: 310 million euros).

Balance sheet structure in percent and in million euros

The balance sheet total increased by 9.4 percent in the year.

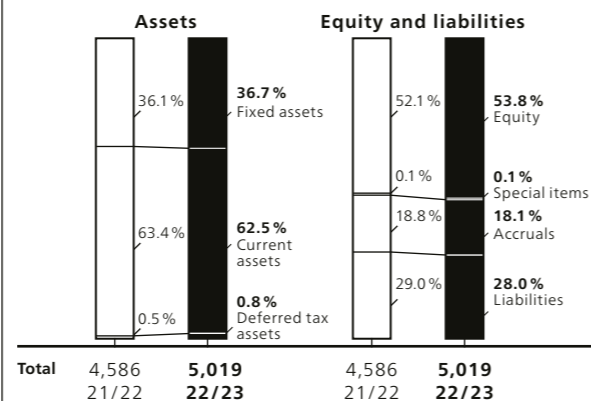

Net assets and financial position:

Sharp rise in trade receivables in particular

The balance sheet total in the fiscal year under review rose by 9.4 percent to 5,019 million euros (previous year: 4,586 million euros).

Fixed assets increased to 1,840 million euros (previous year: 1,656 million euros) – a rise of 11.1 percent. The increase was largely due to a significant rise in new investments in tangible assets (see the comments in the section on investments).

Current assets including prepaid expenses and deferred tax assets rose by 8.5 percent to 3,179 million euros (previous year: 2,930 million euros). Inventories (before down payments received) increased by 14.5 percent to 1,437 million euros (previous year: 1,255 million euros) due to the significantly higher production output. In addition, our efforts to keep delivery times to our customers as short as possible also led to an increase in inventories. However, inventories increased at a below-average rate compared to sales revenues, resulting in a reduction in days inventories outstanding (DIO) from 107 to 96 days. Down payments received decreased slightly to 386 million euros (previous year: 458 million euros). Due to the significant increase in sales revenues, days payments received (DPR) decreased more significantly, falling by 13 days to 26 days (previous year: 39 days).

Trade receivables increased by 29.0 percent to 1,090 million euros (previous year: 845 million euros) as a result of the sharp rise in sales revenues. Consequently, receivables rose almost in proportion to sales revenues, with days sales outstanding (DSO) increasing by only one day to 73 days (previous year: 72 days).

Trade payables rose by 6.5 percent to 448 million euros (previous year: 420 million euros). Days payables outstanding (DPO) decreased by 6 days to 30 days (previous year: 36 days) as a result of sales revenues.

Working capital – the sum of inventories and trade receivables less down payments received and trade payables – increased by 38.6 percent to 1,693 million euros (previous year: 1,222 million euros). Due to the disproportionate increase in working capital compared with sales revenues, the working capital ratio as a percentage of sales revenues rose from 28.9 percent to 31.6 percent.

Cash and cash equivalents fell by 19.2 percent to 649 million euros (previous year: 803 million euros). At 306 million euros, cash inflows from operating activities were substantially lower than in the previous year (431 million euros), with the significant increase in working capital having a particularly negative effect here. Due to the sharp increase in the investment budget, cash outflows from operations-related investing activities were higher than in the previous year at 389 million euros (cash outflows: 219 million euros). Free cash flow in the past fiscal year was therefore negative at -84 million euros (previous year: 212 million euros).

Cash inflows from other investing activities came to 84 million euros (previous year: cash outflows of 143 million euros). The cash inflows resulted primarily from the significant reduction in medium-term financial assets (assets with a remaining term of more than three months). Added to this were declining net investments in financial assets and only very minor additions to the scope of consolidation.

Cash outflows from financing activities fell to 129 million euros (previous year: 280 million euros). In fiscal year 2022/23, new liabilities of 102 million euros were incurred and existing liabilities to external lenders of 13 million euros were repaid.

The sum of all cash-relevant changes in cash in hand therefore amounted to -129 million euros (previous year: -210 million euros).

The net financial position – the sum total of cash and cash equivalents, securities in current assets, and medium-term financial assets included under other assets less financial liabilities – fell by 52.6 percent to 344 million euros (previous year: 727 million euros), mainly as a result of the higher level of investing activities and the increase in working capital.

Equity increased by 13.1 percent to 2,700 million euros in the fiscal year under review (previous year: 2,387 million euros). The sharp increase was mainly due to the very good earnings performance. As in the previous year, decisions on the appropriation of earnings are not made until the following fiscal year in some cases, with the result that consolidated net income attributable to the parent company is recognized in equity. Due to the lower increase in the balance sheet total, the equity ratio increased to 53.8 percent (previous year: 52.1 percent). Economic equity, which includes long-term liabilities to partners, rose by 8.4 percent to 2,710 million euros (previous year: 2,500 million euros), and the economic equity ratio decreased from 54.5 percent to 54.0 percent.

Accruals increased by 5.2 percent to 909 million euros (previous year: 864 million euros). This was mainly due to the increase in personnel accruals and customer-related accruals, and was countered by increased investments in plan assets for the accruals for pensions.

Liabilities increased in total by 4.4 percent to 1,282 million euros (previous year: 1,227 million euros). The development of financial liabilities and trade payables has already been explained above.

Liabilities to partners decreased by 24.8 percent from 372 million euros to 280 million euros. As in the previous year, the appropriation of earnings will in some cases not be decided until after the annual financial statements.

Investments and acquisitions

Investments

in million euros

Investment soared to a new record high in 2022/23. 59.1 percent of our expenditure was in Germany.

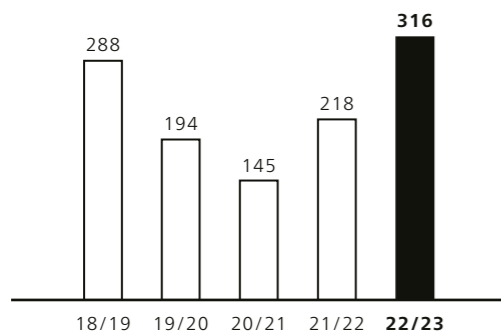

Investment trend:

+44.7%

Level of investment rose to new record high in fiscal year 2022/23

TRUMPF invested more in the past fiscal year than ever before, with investments increasing by 44.7 percent over the previous year's level (218 million euros) to a record high of 316 million euros. Tangible assets accounted for 311 million euros (excluding internally used self-produced machinery in the amount of 105 million euros) and intangible assets for 5 million euros.

Land and structural extensions accounted for 39.7 percent of the total investment amount mentioned above. 23.9 percent was invested in technical equipment and machinery and 34.9 percent in office equipment. 59.1 percent of our investments were in Germany. Construction investments, most of which were made at our headquarters in Ditzingen, accounted for around 44.6 percent of this amount and represented the continuation of construction projects already started in previous years.

28.2 percent of our investments were made in the rest of Europe. The Americas accounted for 6.1 percent of investments and Asia-Pacific for 6.7 percent.

The investment ratio of fixed assets to sales revenues was 5.9 percent (previous year: 5.2 percent). Investments in tangible and intangible assets of 316 million euros in this fiscal year were above the level of depreciation and amortization, which totaled 242 million euros (previous year: 207 million euros).

Acquisitions and divestments

In February 2023, we agreed on a strategic partnership for smart factory solutions with STOPA, one of the leading manufacturers of automated storage systems. In this context, TRUMPF acquired a 25.1 percent stake in STOPA Anlagenbau GmbH. Among other things, STOPA supplies automated storage systems for TRUMPF's Smart Factory solutions. Customers can use them to automate the loading and unloading of their machines and to network them logistically.

In March 2023, we increased our stake in Auroma Technologies Co. DbA Access Laser Company (USA) from 85.0 percent to 100.0 percent.

Employees

Employees worldwide

In Germany, TRUMPF employed 9,124 people. Outside Germany, the number of employees rose to 9,228.

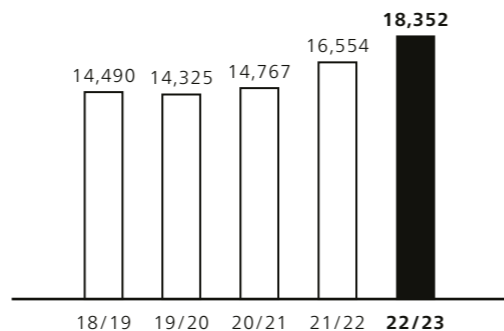

Number of employees:

+10.9%

New employees worldwide

The number of employees working for TRUMPF worldwide increased significantly in the past fiscal year. New positions were created in the growth areas of EUV and Electronics in particular. As of June 30, 2023, we employed 18,352 people (previous year: 16,554).

In Germany, TRUMPF had 9,124 employees as of the balance sheet date (previous year: 8,417) – a rise of 8.4 percent year-on-year.

Outside Germany, the number of employees increased by 13.4 percent to 9,228 (previous year: 8,137).

The training of young skilled workers, engineers, business administrators and IT specialists is very important to us. In the year under review, 550 young people completed a training course or co-op work-study program, resulting in a training ratio of 3.5 percent for the company (previous year: 3.3 percent).

Research and Development

Development costs remain high

Research and development

in million euros

Our research and development ratio as a percentage of sales revenues remains at a very high level of 8.9 percent.

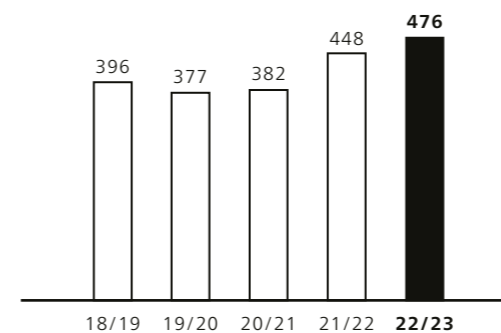

Research and development costs trend:

+6.3%

At 476 million euros, research and development costs were significantly higher than the previous year's figure of 448 million euros. The research and development ratio decreased to 8.9 percent (previous year: 10.6 percent), but remains at a historically high level.

Employees in research and development

As of the reporting date, 2,853 employees in the TRUMPF Group were working on the products and ideas of tomorrow.

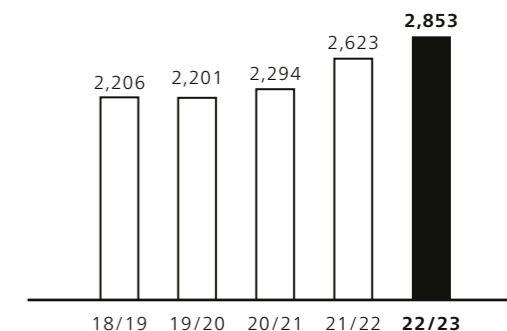

Number of employees in R+D:

+8.8%

The number of employees working on new products for TRUMPF rose by 8.8 percent to 2,853 (previous year: 2,623). By conducting intensive technology scouting, TRUMPF wishes to evaluate trends in the technology areas relevant to the Group at an early stage and then initiate appropriate measures. These measures include building up new skills, launching partnerships with start-ups, and assessing non-organic growth options using a strategically oriented pre-M&A process. The aim is to develop new business opportunities and/or expand existing business fields.

In addition to cooperations with start-ups, these can also be acquired as suppliers for TRUMPF or venture capital projects can emerge. In the area of minority investments, we continue to supplement internal developments. For example, in July 2022, TRUMPF Venture II GmbH invested in the "digital nose", a Norwegian start-up that develops compact gas sensors based on MEMS technology. This allows another element of human-machine interaction to be digitalized. This was followed in October 2022 by an investment in a Spanish start-up developing chips for extremely powerful random number generators for highly secure encryption, which are used in particular for quantum computing encryption processes using TRUMPF lasers. Also in October 2022, a minority stake was acquired in a German start-up that makes spare parts easily identifiable via photos and artificial intelligence in the TRUMPF Service app. An investment in a spin-off from the Technical University of Munich, which has developed a medical application that uses optoacoustic imaging to achieve unprecedented resolution, followed in December 2022. Finally, TRUMPF completed its investment in a German

start-up for simulation-based development of quantum systems in May 2023.

In the past fiscal year, TRUMPF spun off its sus.raw GmbH start-up, which recycles sustainable secondary raw materials directly from TRUMPF customers into metal production.

TRUMPF has been running its own start-up program "Internehmertum" since 2017. As part of this program, innovative ideas are developed into scalable business models and independent companies established. In the past fiscal year, preparations were made for the spin-off of a start-up on appreciation culture in companies as an HR tech tool.

Opportunities and Risks

Risk management

As a globally active high-tech company, TRUMPF is exposed to a variety of risks, which are handled by an integrated risk management system. The central risk management function regularly identifies and evaluates risks to the TRUMPF Group as part of the risk analysis and defines strategies for dealing with these risks. Cooperation between divisions with specific risk analyses, business continuity management (BCM) and central risk management is intended to ensure the integrated process that creates risk transparency at all levels. The results are discussed and processed with the responsible management teams in the various countries. In addition, the Managing Board is informed about the risk situation on an annual basis and separately as required.

New technologies and other innovations guarantee sustainable growth. Conversely, they are associated with market launch risks and product development risks. We take concrete measures to counteract these potential technology and quality risks. One of the strengths of the TRUMPF Group is the safeguarding of elementary technology even within its own supply chain (production network). At the same time, interruptions in internal production can result in a high risk for the value stream. The connections and dependencies within the internal production network must therefore be protected. The risks of interruption should be further reduced through consistent implementation of BCM for critical internal supplies. The risk perception with regard to IT risks and information security risks remains high. Even with a view to the supply situation, which is easing overall, there are still isolated high risks relating to the availability of materials. By contrast, geopolitical uncertainties in the global economy in particular are leading to a high risk perception with regard to trade wars, sanctions, and

permits. Conflicts between countries may lead to supply chain disruptions or the loss of capital or markets. For relevant product lines, this risk is taken into account to secure the value stream.

The risk management and business continuity management teams continuously monitor the situation. Scenarios relating to business interruptions to infrastructure (particularly in production), personnel, IT and supplies are considered by BCM as standard.

The Managing Board and the heads of the Group's business divisions and central corporate departments are given monthly updates on the results of operations, net assets, and financial position.

The order intake, an important key figure, is reported on a daily basis. The key financial figures and analyses of these figures by the controlling department provide the basis on which the Managing Board can identify and evaluate potential risks and decide on appropriate countermeasures.

Our corporate planning process includes an analysis of alternative scenarios for possible trends within the TRUMPF Group and their potential risks. An interest and currency committee, which meets monthly, manages and controls cash flow, currency and interest rate risks at Group level. In addition, market and competition analyses enhance risk transparency.

To manage the effects of the coronavirus pandemic, the parent company's central crisis team and the local crisis teams at the subsidiaries worked closely together until March 2023. With the official end of the pandemic and the sharply reduced risk as a result, the coronavirus crisis team ceased its work in March.

Market opportunities and risks

The negative economic effects of the Russian war of aggression against Ukraine, alongside high inflation rates and correspondingly tighter monetary policies on the part of central banks are likely to continue to have an impact in 2024. The IMF therefore expects growth of 3.0 percent in 2024, a similarly moderate rate as in 2023.

Thanks to our global presence, we nevertheless see good opportunities to benefit from the growth of individual markets in the global economy. At the same time, the global uncertainties mentioned above will lead to risks for our business. We are prepared for this through targeted measures, particularly in purchasing and production, and through prepared measures to compensate for global economic risks. Overall, even in uncertain times the opportunities clearly outweigh the risks for us.

Opportunities and risks from the end-to-end digitalization of customer processes

TRUMPF offers its customers a comprehensive product portfolio for digitally connected production. Its modular solutions enable both vertical and horizontal networking of production processes right through to Smart Factory solutions, i.e. end-to-end digital connectivity in production. When introducing digitally networked processes, we provide our customers with comprehensive advice and offer tailored software solutions.

In the context of digitalization, potential risks arise in particular due to increasing dependencies on IT systems and the associated losses in the event of failures. The risks are considered and taken into account during risk management.

Opportunities and risks from the end-to-end digitalization of business processes

In light of the upcoming migration to the new SAP release (SAP S/4HANA), business processes are being harmonized and standardized and a business process management organization (BPMO) is being rolled out. The efforts are intended to enable a successful migration to SAP S/4HANA and will be subsequently used for process innovations.

TRUMPF is applying a multifunctional perspective and pursuing an integrated end-to-end (E2E) approach to process observation and optimization. The focus is on documenting and training process standards and variants as well as standardizing master and transaction data.

Isolated risks relating to a lack of systematic process digitalization are also recorded through risk management and measures are implemented.

Opportunities from continued growth in demand for EUV lithography

The opportunities created by the growing demand for EUV lithography were confirmed in the past fiscal year and continue to exist.

Microchip manufacturers are significantly expanding their production with EUV lithography equipment in order to meet the growing global demand for semiconductor microchips. In addition to expanding absolute capacities, they are also extending their global footprint beyond the focus countries of Taiwan, the US, and Korea.

High-performance laser amplifiers from TRUMPF are used in the production of microchips with EUV lithography. They are used to generate a luminous plasma that delivers extreme ultraviolet (EUV) radiation to expose the wafers.

We assume that there will be a sustained increase in demand for these systems over the next few years.

Opportunities in the additive manufacturing market

The market for additive manufacturing processes is growing steadily. Our fundamental conviction that additive manufacturing is a pioneering process that TRUMPF can use to occupy a growth field with potential is becoming more firmly established.

Many industries such as medical and dental technology, the automotive industry, aerospace and tool and mold making use TruPrint machines. TRUMPF itself also uses TruPrint machines to produce series parts for its own machines and components. TRUMPF offers both of the relevant processes for industrial metal 3D printing: laser metal fusion and laser metal deposition.

Opportunities from our sales financing solutions

TRUMPF has been offering its customers investment financing since 2001, and since 2014 has also been doing so with TRUMPF Financial Services GmbH as a full-service bank. This gives customers in around 30 countries access to suitable lending and leasing offers. In addition to financing TRUMPF products, we can also finance raw materials for processing on TRUMPF machines as part of a purchase financing arrangement. TRUMPF Bank also offers covered financial loans for export financing in many markets.

Financial opportunities and risks

The TRUMPF Group regularly safeguards its liquidity through medium to long-term measures. Our liquidity reserves are still at a high level. Cash and cash equivalents are mainly invested in the money market on a short-term basis. When investing our liquidity reserves, we ensure that the risk is diversified by spreading the investments across several financial institutions and instruments. We only consider banks with a good credit rating.

The syndicated credit line of 500 million euros successfully concluded in 2020 is due to expire in 2027. In the case of the sustainability component (ESG component) agreed last year, consisting of the core components of employee satisfaction, occupational safety, and climate protection, two out of three sustainability target values have been achieved. Accordingly, the margin has remained unchanged.

In total, there were unutilized credit lines of 479 million euros as of the balance sheet date.

Our liquidity reporting system enables us to check the liquidity of all our subsidiaries on a daily basis.

Exchange rate and interest rate risks represent additional financial risks for us.

As the eurozone represents our main sales market with a 46.3 percent share of sales revenues, and as we are partly able to offset foreign currency payments thanks to our international production network and global purchasing, we consider our exchange rate risk to be limited.

At TRUMPF, derivative financial instruments are not used for speculative purposes, but solely to hedge underlying transactions. The risk of fluctuations in the market prices of forward exchange transactions is offset by the opposite trend in the market value of the underlying transactions. Hedging takes place within the Group, i.e. with the companies of the TRUMPF Group, to cover foreign currency risks from posted, pending, and anticipated underlying transactions. TRUMPF also enters into external hedging transactions with banks in line with the forward exchange transactions concluded internally, and taking into account net exposures.

We systematically hedge net exposures in US dollars, British pounds, Japanese yen, Chinese renminbi, Korean won, Polish złoty, and Czech koruna using standardized currency hedging instruments such as forward exchange transactions. Other currencies are hedged on a project-related basis.

In the eurozone, we concentrate our liquidity on a daily basis with the aid of a cash pool system that ensures transnational liquidity balancing. We have a similar system in use at our subsidiaries in China. Multilateral netting of receivables and liabilities increases transparency and facilitates the handling of the Group's internal cash flows.

Internal audits are intended to create additional transparency regarding the financial situation of our subsidiaries.

Strategic and operational opportunities and risks

Innovations

In the past fiscal year, we successfully invested in innovative technologies, which opened up new growth opportunities. The introduction of innovative new products enabled us to strengthen our market position.

Our innovation strategy is based on internal and external innovation approaches, and we see research and development as a key driver of our business success. Targeted investment in research and development and a strong culture of innovation form the basis for our innovative products. Our innovation management unit continuously searches for future technologies and takes steps to integrate them into our technology landscape. Identifying technology trends helps us to deploy open innovation approaches in a targeted manner. This enables us to strengthen our competitive position by integrating external expertise and partnerships. Close collaboration with universities, non-university research institutions and start-ups is another important pillar for successfully driving innovation.

A rapidly changing technology environment poses risks to business continuity and the protection of intellectual property. For this reason, we actively address the opportunities and risks associated with innovation. Concrete measures ensure that we can continue to operate successfully in the market in the future.

Intellectual property

We safeguard our investments in research and development by ensuring that our development, product management, and patent departments work hand in hand. The aim of our patent work is to build and manage a patent portfolio that is aligned with our business strategy and gives TRUMPF advantages in terms of freedom of action, exclusivity, and the exploitation of patents. To achieve this, our IP experts provide support as we move into new technologies and secure our intellectual property by proactively generating, defending, and enforcing patents and design protection rights. Our focus here is on our core markets.

Acquisitions

To achieve our strategic goals, we also carry out targeted corporate acquisitions to complement our organic growth. The focus here is on the acquisition of technological know-how and new, sustainable business models. To obtain the greatest possible certainty about the future development potential of an acquisition project, a large number of experts and decision-makers from the Group's business divisions and central departments is involved in the individual projects.

Procurement

We regularly review the purchasing volume for optimization potential and organize cross-location calls for tenders centrally. We keep risks low through comprehensive monitoring, which has again been significantly refined in the light of recent years. The careful selection and continuous evaluation of our strategic suppliers, also with a view to the likelihood of failure as well as a stringent supplier approval process give us the necessary transparency at all times with regard to possible risks. The close exchange of information between our technical experts provides increasing transparency on the risks of failure and availability of individual components. Continuous monitoring of delivery quality and reliability enables us to derive suitable quality assurance and supplier development measures.

The provision of our basic supplies by third parties was severely challenged in the past fiscal year by supply bottlenecks, partly due to Russia's war of aggression against Ukraine, which resulted in longer delivery times for individual product families. Active demand and escalation management limited the supply bottlenecks. The availability of natural gas was also ensured at all times.

Based on the measures taken, we do not expect any significant supply bottlenecks to occur in the following fiscal year and expect the overall situation to normalize further.

Production

We are continuously developing our production processes as the digitalization of the entire order-to-cash process also affects large parts of production. To achieve this, we are continuing to drive forward the consistent standardization of processes, systems and data. Our lean production philosophy, known as SYNCHRO, is a key prerequisite for this.

The combination of risk management and BCM means that risks, particularly in production, are systematically identified, assessed and measures derived. In addition, emergency concepts are developed for critical areas and scenarios. This is designed to safeguard business operations even in the event of scenarios that could lead to a business interruption.

The TRUMPF production network secures a fundamental part of value creation in the TRUMPF Group. The failure of internal production locations therefore represents a risk for the TRUMPF Group. This risk is specifically hedged by the BCM activities. There are also challenges with regard to the general labor market situation, including filling vacant positions in production.

In addition, potential property and fire damage, business interruption, and public and product liability risks are insured through an international insurance program and local coverage. We regularly evaluate and audit our production sites with our insurance broker.

Cyber security

IT risks are one of the key areas on which we focus. We permanently monitor our central IT systems and adapt our cyber security roadmap annually and as needed to the threat situation and legal framework conditions.

A consequence of increasing digitalization is that the focus is also shifting to the security of the software used in TRUMPF products. Central governance for secure software development, central security specifications, security response and a secure development infrastructure is implemented through expert support for the development teams and specialized training to ensure that security requirements are taken into account early in the development process.

Thanks to the newly introduced worldwide regular phishing simulation and the switch to mandatory e-learning on cyber security for the entire TRUMPF Group, all employees are trained to act in a security-conscious manner.

To externally validate the above measures to protect our data and our customers' data, we are aiming for ISO 27001 certification in the next fiscal year.

Cyber security risks that could lead to a severe business interruption are picked up by BCM and contingency plans are reviewed with the divisions and with IT.

Employees

The employee turnover rate in the Group remained unchanged at 6.0 percent in the past fiscal year. However, in Germany, the turnover rate increased significantly to 4.3 percent (previous year: 3.4 percent). The increased turnover rate since the pandemic is an economy-wide phenomenon. There has been a huge increase in people's willingness to quit and change jobs, and the labor market has now developed into an employee market.

Due to the shortage of skilled workers and an attractive labor market, filling certain positions, especially in technical professions, remains challenging. At the same time, retaining employees for the long term is becoming increasingly important for companies. For this reason, we are increasingly focusing on employee retention activities and keeping measures for securing the next generation of employees at a high level.

The opportunities for TRUMPF in what has been dubbed the "Great Resignation" continue to lie in taking advantage of the upbeat mood of employees from other companies who are willing to change jobs, and in using our strong employer brand to win them over and retain them in the long term.

With a Group-wide occupational safety target, we have set ourselves the goal of continuously reducing the number of accidents worldwide. Our goal is to reduce the frequency rate to best-in-class level. To achieve this, we are implementing our occupational health and safety policy and local TRUMPF safety standards. We aim to continuously improve the level of occupational health and safety through standardized processes and instruments and by monitoring the results through Group-wide audits.

Compliance and data protection

The Managing Board expects all employees to comply with the law in their business dealings. To ensure this, TRUMPF is continuously developing its compliance management system. Individual needs for improvement have been identified and concrete measures derived and implemented. Compliance training for managers has been rolled out at additional locations and internationalized. The clear focus in further developing the compliance management system this fiscal year was on implementing the requirements of the Supply Chain Due Diligence Act (LkSG). The project team incorporated the requirements of the Act into processes, thereby ensuring that the stipulations are implemented appropriately.

The protection of personal data is also important to the Managing Board. To ensure compliance with the legal requirements of the EU General Data Protection Regulation, TRUMPF has established a data protection management system that corresponds to the compliance management system in terms of its systematics and structure and is also being continuously developed. In the last fiscal year, the introduction of a digital tool for mapping the main data protection processes was a focal point. The procedure directory and the documentation of data subject inquiries and data breaches were integrated into the tool. Additional processes will follow. The audit program was also further developed.

The overriding aim of both management systems is to promote a corporate culture in which people talk openly about compliance and data protection, know the rules, and adhere to them as a matter of course.

Assessment of the company's risk situation

No risks that could substantially endanger the Group's status as a going concern have been identified. Risk management at TRUMPF is designed to enable risks to be identified promptly in order to initiate adequate measures and ensure the continuity of business operations. The focus is on TRUMPF-specific risk categories such as production and development as well as financial risks and risks influenced by the environment. Business interruption risks continue to be specifically considered by the BCM system implemented in the scenario analysis. This results in a far-reaching approach that creates transparency about the risk situation.

Outlook

Machinery and plant engineering sector anticipates decline in orders and production

Following the positive signals from global economic development in early 2023, the German Mechanical Engineering Industry Association (VDMA) is forecasting a fragile upturn. Incoming orders in the mechanical engineering sector have been falling for the majority of member companies since the second quarter of 2023. The Association is therefore assuming a 2 percent drop in production for 2023 as a whole. The VDMA is also assuming a real decline in sales revenues of one percent for the euro countries, while forecasting modest growth of one percent in global sales revenues for all of 2023.

Most of the laser industry expects sales revenues to grow

86 percent of members of the VDMA Laser Working Group expect sales revenues to increase in 2023 compared to 2022, with the amount of this increase varying widely, according to member companies. 19 percent stated that sales revenues would increase by up to 5 percent. 53 percent expect a 6 to 15 percent growth in revenues. 14 percent of member companies anticipate a decline in revenues of 15 to 20 percent. Those companies expecting sales revenues to grow see the US in particular as a growth driver. China, on the other hand, is currently viewed rather critically.

Outlook for the company

TRUMPF expects sales revenues to continue to grow in fiscal year 2023/24

Due to the continuing uncertainty of the current economic situation, we expect the order intake to flatline at its current level in the first half of the coming fiscal year. In the second half we expect orders to pick up again. Overall, we expect low single-digit percentage growth in our order intake compared with the past fiscal year.

In terms of sales revenues, we will continue to benefit from our high order backlog. We therefore forecast continued growth, albeit at a lower rate than in the robust past fiscal year. On balance, we expect sales revenues to grow in the high single-digit percentage range in the coming fiscal year.

EBIT will also show a clear positive development in the lower double-digit percentage range in the coming fiscal year due to the anticipated continuation of revenue growth. All in all, we are expecting a slightly higher EBIT margin than this year. However, we anticipate a slight decline in value added, mainly due to the expected increase in the cost of capital.

With regard to our two business divisions, Machine Tools and Laser Technology, we expect a similar development in order intake in the coming fiscal year. Following the sharp decline in orders for machine tools in the past fiscal year, the business division is expected to grow again slightly in the coming fiscal year. However, we do not expect orders to pick up until the second half of the fiscal year. From the coming fiscal year 2023/24 we will report the Laser Technology business division without Electronics, which will be managed as a separate business field in the future. For Laser Technology, excluding the separate Electronics business field, we expect slight growth in the order intake. For both business divisions, we expect a single-digit percentage increase in sales revenues, which is likely to be slightly higher for Laser Technology, excluding the Electronics business field, than for Machine Tools.

In the EUV business field, our forecasts for the coming fiscal year are optimistic. In EUV lithography for the imaging of microprocessors, we anticipate a further substantial increase in the order intake and a slight rise in sales revenues in the coming fiscal year. In this highly innovative manufacturing process, TRUMPF, together with ZEISS, continues to be the key supplier to our customer ASML.

This report contains forward-looking statements that are based on current assessments of future developments. As such, they are subject to risks and uncertainties that are beyond our control or precise assessment. This may result in the actual results differing from the statements made in this report.

Ditzingen, September 4, 2023

TRUMPF SE + Co. KG represented by general partner Leibinger SE, the latter represented by the Managing Board

Dr. phil. Nicola Leibinger-Kammüller,
President and Chairwoman
Dr. rer. pol. Lars Grünert
Dr.-Ing. Mathias Kammüller
Dipl.-Betriebsw. Oliver Maassen
Dr.-Ing. Stephan Mayer
Dr. rer. nat. Berthold Schmidt
Dr. rer. nat. Hagen Zimer



Consolidated Financial Statements

Consolidated Balance Sheet

as of June 30, 2023

ASSETS in k€	Notes	06/30/2023	06/30/2022
FIXED ASSETS	1		
Intangible assets		81,565	127,826
Tangible assets		1,608,750	1,433,528
Financial assets		150,081	95,001
		1,840,396	1,656,355
CURRENT ASSETS			
Inventories (after offsetting against down payments received)	2		
Inventories		1,437,218	1,255,346
Down payments received		-386,086	-457,847
		1,051,132	797,499
Receivables	3		
Trade receivables		1,089,859	844,809
Other receivables		19,612	10,712
		1,109,471	855,521
Other assets	4	285,733	414,659
Cash and cash equivalents, securities	5	648,717	803,159
		3,095,053	2,870,838
PREPAID EXPENSES	6	44,658	33,938
DEFERRED TAX ASSETS	7	38,963	24,972
		5,019,070	4,586,103

EQUITY AND LIABILITIES in k€	Notes	06/30/2023	06/30/2022
EQUITY	8	2,700,399	2,387,106
SPECIAL ITEMS	9	5,780	6,382
ACCRUALS			
Accruals for pensions and similar obligations	10	243,154	281,013
Other accruals	11	665,411	582,830
		908,565	863,843
LIABILITIES	12		
Trade payables		447,677	420,367
Financial liabilities		410,338	319,149
Liabilities to partners		279,932	372,049
Other liabilities		143,695	115,884
		1,281,642	1,227,449
DEFERRED INCOME	13	122,684	101,323
		5,019,070	4,586,103

Consolidated Profit and Loss Statement

for fiscal year 2022/23

in k€	Notes	2022/23	2021/22
Sales revenues	14	5,364,513	4,222,768
Cost of goods sold	15	-3,352,520	-2,555,577
Gross profit on sales		2,011,993	1,667,191
Sales costs	16	-686,556	-547,822
Research and development costs	17	-476,315	-448,007
General administrative costs	18	-281,396	-236,772
Other operating income	19	326,925	266,593
Other operating costs	20	-277,150	-227,850
Financial and investment result	21	-8,896	-63,831
Earnings before taxes		608,605	409,502
Taxes on income	22	-146,805	-99,358
Earnings after taxes/Consolidated net income		461,800	310,144
Allocation to reserves according to partnership agreement		-58,392	-46,335
Allocation to partners' accounts within liabilities		-47,048	-1,420
Allocation to other revenue reserves		-114,289	-36,943
Gains/losses attributable to minority interests	8	-6,793	-7,007
Consolidated net income attributable to parent company		235,278	218,439
For informational purposes:			
Taxes of partners	22	-121,294	-118,324

Consolidated Statement of Changes in Equity

for fiscal year 2022/23

in k€	Equity of the parent company				Equity of the parent company			Minority interests			Group equity	
	Fixed capital	Revenue reserves			Consolidated net income attributable to parent company	Equity difference from foreign currency translation	Total	Minority interests before equity difference from foreign currency translation and annual result	Equity difference from foreign currency translation attributable to minority interests	Gains/losses attributable to minority interests	Total	Total
		Capital shares	Reserves according to partnership agreement	Other revenue reserves								
06/30/2021	100,000	162,684	1,667,221	1,829,905	-	60,705	1,990,610	19,614	-876	6,516	25,254	2,015,864
Transfer	-	-	-	-	-	-	-	6,516	-	-6,516	-	-
Allocation to partners' accounts within liabilities	-	-	-1,420	-1,420	-	-	-1,420	-	-	-1,311	-1,311	-2,731
Foreign currency translation	-	-	-	-	-	76,611	76,611	-	440	-	440	77,051
Other changes	-	-	195	195	-	-	195	-13,417	-	-	-13,417	-13,222
Consolidated net income	-	46,335	38,363	84,698	218,439	-	303,137	-	-	7,007	7,007	310,144
06/30/2022	100,000	209,019	1,704,359	1,913,378	218,439	137,316	2,369,133	12,713	-436	5,696	17,973	2,387,106
Transfer	-	-	-	-	-	-	-	5,696	-	-5,696	-	-
Allocation to partners' accounts within liabilities	-	-	-47,048	-47,048	-53,439	-	-100,487	-	-	-2,213	-2,213	-102,700
Allocation to/withdrawal from reserves	-	165,000	-	165,000	-165,000	-	-	-	-	-	-	-
Foreign currency translation	-	-	-	-	-	-43,846	-43,846	-	410	-	410	-43,436
Other changes	-	-	419	419	-	-	419	-2,790	-	-	-2,790	-2,371
Consolidated net income	-	58,392	161,337	219,729	235,278	-	455,007	-	-	6,793	6,793	461,800
06/30/2023	100,000	432,411	1,819,067	2,251,478	235,278	93,470	2,680,226	15,619	-26	4,580	20,173	2,700,399

Consolidated Cash Flow Statement

for fiscal year 2022/23

in k€	2022/23	2021/22
CONSOLIDATED NET INCOME	461,800	310,144
+/- Elimination of financial and investment result	17,753	63,831
+/- Elimination of income tax expenses	146,804	99,358
= Consolidated net income before financial and investment result and income taxes	626,357	473,333
-/+ Income taxes paid/received	-160,625	-89,461
+/- Elimination of depreciation and amortization/write-ups of fixed assets	241,491	217,037
-/+ Elimination of gain/loss from the disposal of fixed assets	-9,526	-29
-/+ Increase/decrease in inventories and trade receivables	-537,852	-311,737
+/- Increase/decrease in trade payables	37,710	71,078
+/- Increase/decrease in accruals	115,119	70,898
+/- Change in other assets and liabilities	34,210	34,006
+/- Elimination of other non-cash expenses/income	-41,215	-34,202
= Cash inflow from operating activities	305,669	430,923
- Cash paid for investments in tangible assets	-426,448	-269,334
+ Cash received from the disposal of tangible assets	41,631	54,646
- Cash paid for investments in intangible assets	-4,892	-4,179
+ Cash received from the disposal of intangible assets	369	218
= Subtotal cash outflow from investing activities (operating)	-389,340	-218,649
- Cash paid for investments in financial assets	-110,062	-70,185
+ Cash received from the disposal of financial assets	58,280	16,292
+/- Cash received/paid from the acquisition of consolidated companies	-2,931	-27,320
+ Cash received from financial investments as part of short-term cash management	127,000	-
- Cash paid for financial investments as part of short-term cash management	-	-70,282
+ Dividends received	1,570	1,074
+ Interest received	10,524	7,620
= Subtotal cash inflow/cash outflow from investing activities (others)	84,381	-142,801
= Cash outflow from investing activities	-304,959	-361,450
- Cash paid to partners	-208,982	-251,441
- Dividends paid to other partners	-236	-191
+ Cash received from the issuance of loans and other financial liabilities	101,605	30,561
- Cash repayments of loans and other financial liabilities	-12,505	-51,538
- Interest paid	-9,201	-7,257
= Cash outflow from financing activities	-129,319	-279,866
CHANGE IN CASH IN HAND	-128,609	-210,393
+/- Change in cash in hand due to exchange rate differences	-30,330	35,986
+/- Change in cash in hand due to consolidation activities	4,143	3,326
+ Cash in hand at the start of the fiscal year	802,691	973,772
= Cash in hand at the end of the fiscal year	647,895	802,691
COMPOSITION OF CASH IN HAND		
+ Cash and cash equivalents	648,628	803,084
- Liabilities to banks payable on demand	-733	-393
= Cash in hand at the end of the fiscal year	647,895	802,691

Notes to the Consolidated Financial Statements

Notes to the Consolidated Financial Statements

for fiscal year 2022/23

Principles and methods

TRUMPF SE + Co. KG is listed in the commercial register of Stuttgart District Court under company registration number HRA 201460. The company has its head office at Johann-Maus-Strasse 2, 71254 Ditzingen, Germany.

The consolidated financial statements for the fiscal year 2022/23 have been prepared in accordance with Article 264a of the German Commercial Code (HGB), applying the provisions of Articles 290 et seq. HGB. The consolidated financial statements have been prepared in accordance with the accounting and valuation regulations of the HGB applicable to large corporations, taking into account the separate regulations for partnerships and the supplementary provisions of the parent company partnership agreement, and with partial appropriation of profits. In accordance with Article 298 (1) HGB in conjunction with Article 244 HGB, the consolidated financial statements have been prepared in euros. The consolidated profit and loss statement was prepared according to the cost-of-sales method.

Various items in the consolidated balance sheet and the consolidated profit and loss statement have been combined for greater clarity and are disclosed separately in the notes to the consolidated financial statements.

Accounting and valuation

The financial statements of the companies included in the consolidated financial statements are prepared, as previously, in accordance with uniform accounting and valuation principles. If adjustments to Group-wide accounting and valuation principles are necessary due to national regulations, this is done in a "Handelsbilanz II" (balance sheet for consolidation purposes).

Intangible and tangible assets are generally stated at acquisition or manufacturing cost, net of regular amortization or depreciation. Intangible and tangible assets are amortized and depreciated using the straight-line method. If lower valuations were required, extraordinary depreciations were recognized to the fair value.

For regular amortization and depreciation, the following useful lives are assumed in the main: 3 to 5 years for software, 6 to 8 years for acquired customer bases, 5 to 8 years for technological know-how, 10 years for trademark rights, 25 to 50 years for buildings, 12 years for technical plant and machines, and 3 to 20 years for other equipment and factory and office equipment. Acquired goodwill is amortized over 5 years on the basis of past internal experience, especially with regard to product life cycles.

Internally used machines are used for testing or training purposes or as showroom and demonstration machines. These are reported under fixed assets and depreciated over 5 years. Machines leased to customers are also reported under fixed assets and depreciated over the contract term.

Payments on account are recognized at nominal value.

In the case of **financial assets**, participations and shares in non-consolidated affiliated companies are carried at the lower of acquisition cost or fair value, and loans are carried at nominal value. For the accounting and valuation of shares in associated companies, we refer to the explanations on shareholdings and scope of consolidation. The long-term investments included under financial assets are carried at acquisition cost.

Inventories of raw materials, consumables and supplies, and merchandise are carried at the lower of acquisition cost or market value. Work in progress and finished goods are valued at manufacturing cost. In addition to direct material and production costs, this also includes an appropriate allocation of material and production overheads and the fixed asset depreciation expenses attributable to the manufacturing process. Manufacturing costs do not include interest on borrowed capital, and general administrative costs are not capitalized.

Inventories are written down to fair value if, on the balance sheet date, this value is lower than the acquisition or manufacturing cost due to lower replacement costs or sales market prices, excess inventories, or unsaleability.

Down payments received are recognized at nominal value and openly deducted from inventories.

Receivables and other assets are stated at the lower of their nominal value or fair value on the balance sheet date. Appropriate write-downs are made for receivables whose collectability involves recognizable risks; uncollectable receivables are written off. The general credit risk is covered by an appropriate lump-sum bad debt allowance for net receivables for which no specific bad debt allowance has been created.

Securities in current assets are stated at the lower of acquisition cost or fair value on the balance sheet date.

Cash and cash equivalents (cash, bank balances and checks) are carried at nominal value.

Prepaid expenses comprise payments made before the balance sheet date provided that they represent expenses for a specific period after that date. Debt discounts are capitalized and amortized over the term of the corresponding loans.

To calculate **deferred taxes** due to temporary or quasi-permanent differences between the commercial values of assets, liabilities, prepaid expenses and deferred income and their tax values, or due to tax loss carry forwards, the amounts of the resulting tax burden or relief are valued at the expected company-specific tax rates at the time the differences are reversed and are not discounted. Deferred tax assets and liabilities are disclosed net. In the event of a surplus of deferred tax assets from valuation differences on the balance sheet date, no use is made of the option for recognition under Article 274 (1) sentence 2 HGB.

Fixed capital is recognized at nominal value.

Special items include investment grants and subsidies for fixed assets. These are released in installments over the useful life of the subsidized assets.

Accruals for pensions and similar obligations are measured on the basis of actuarial calculations using the projected unit credit method, taking into account the 2018 G mortality tables of Prof. Dr. Heubeck. In accordance with the regulation in Article 253 (1) HGB, the actuarial calculation of pension accruals takes into account expected future salary and pension increases and expected fluctuation. Accruals for pensions and similar obligations are discounted at a flat rate using the average market interest rate of the past 10 years, as published by Deutsche Bundesbank, and based on an assumed remaining term of 15 years.

In the fiscal year 2022/23, the calculation of pension obligations was based on the following parameters:

- Interest rate: 1.80 percent p.a.
(previous year: 1.76 percent p.a.)
- Wage and salary increases: 3.00 percent p.a.
(previous year: 3.00 percent p.a.)
- Future pension increases: 2.00 percent p.a.
(previous year: 1.75 percent p.a.)

Accruals for pensions and similar obligations are offset against assets that are used exclusively to meet these obligations and that cannot be accessed by any other creditors. The fair value of these offset assets was derived from the market values.

Other accruals take into account all uncertain liabilities and contingent losses on pending transactions. They are stated at the necessary settlement value according to sound business judgement. Accruals with a remaining term of more than one year have been discounted in accordance with Article 253 (2) sentence 1 HGB. Economic hedging relationships between derivative financial instruments and underlying transactions are accounted for by forming valuation units. Accordingly, in the case of effective hedging relationships, a provision for onerous contracts is not formed for financial instruments with negative market values.

The accruals for obligations relating to phased retirement programs existing on the balance sheet date have been calculated according to actuarial principles at an interest rate of 0.76 percent p.a. (previous year: 0.34 percent p.a.). They have been offset against assets that are used exclusively to meet obligations under the phased retirement program and that cannot be accessed by any other creditors. The fair value was derived from the market values.

The accruals for obligations relating to anniversary obligations existing on the balance sheet date have been calculated according to actuarial principles at an interest rate of 1.57 percent p.a. (previous year: 1.34 percent p.a.).

Accruals for obligations relating to the "TRUMPF Familien- und Weiterbildungskonto" have been offset against assets that are used exclusively to meet these obligations and that cannot be accessed by any other creditors. The fair value was derived from the market values.

Liabilities are stated at their settlement value.

Deferred income includes receipts prior to the balance sheet date if they constitute income for a specific period after that date.

Shareholdings and scope of consolidation

The Leibinger family and the Berthold Leibinger Stiftung GmbH directly and indirectly hold all shares in TRUMPF SE + Co. KG, Ditzingen. TRUMPF SE + Co. KG manages all

domestic and foreign subsidiaries of the TRUMPF Group. Consolidation takes place at the level of TRUMPF SE + Co. KG as the parent company. The list of shareholdings can be found in the separate annex after the notes to the consolidated financial statements.

In addition to the parent company, the scope of consolidation includes 29 (previous year: 28) German and 57 (previous year: 56) foreign subsidiaries. In fiscal year 2022/23, two companies have been included in the consolidated financial statements for the first time in accordance with the principles of full consolidation. The initial consolidations did not have a significant influence on the results of operations and net assets of the Group so that comparability with the previous year is not limited.

37 (previous year: 35) subsidiaries and 13 (previous year: 5) associated companies are not included in the consolidated financial statements for reasons of immateriality. Their combined net income and sales revenues only account for less than 1 percent of consolidated net income and sales revenues, respectively. Consequently, they are considered irrelevant for the fair presentation of the results of operations, net assets and financial position of the Group.

Consolidation principles

Capital consolidation is carried out using the revaluation method in accordance with Article 301 (1) HGB. In the course of this, the equity of the subsidiaries is recognized at the amount corresponding to the fair value of the assets and liabilities to be included in the consolidated financial statements.

Any residual debit difference remaining after offsetting is reported as goodwill on the assets side and amortized over its expected useful life. As at the balance sheet date, residual debit differences amounted to k€ 46,047. Amortization is on a straight-line basis over 5 years, based on the historical useful life of the acquired goodwill.

If the consolidation measures pursuant to Articles 300 to 305 HGB result in differences between the commercial values of assets, liabilities, as well as their tax base that are expected to reverse in later fiscal years, the future tax relief or tax charges are recognized as deferred tax assets or liabilities in the consolidated balance sheet. Deferred taxes are calculated on the basis of the individual company tax rates applicable at the time when the differences

are expected to reverse. At Group level, the tax rates of the subsidiaries concerned are used. These tax rates are between 9 percent and 34 percent. Deferred tax assets and liabilities are disclosed net. Deferred taxes from consolidation measures are combined with the deferred tax liabilities resulting from the application of Article 274 HGB to form a single item in the consolidated balance sheet.

Intercompany profits and losses resulting from intercompany deliveries of goods and services are eliminated through the profit and loss statement.

Receivables and liabilities between consolidated companies are offset against each other. Currency-related differences arising from this have been recognized in the consolidated profit and loss statement in accordance with German Accounting Standard (DRS) 25.

Revenues from intercompany sales and intercompany income are offset against the corresponding expenses.

Foreign currency translation

In the individual financial statements, transactions in foreign currencies are generally recorded at the historical exchange rate at the time of initial recognition. As at the balance sheet date, foreign currency receivables and liabilities are translated at the average spot exchange rate. In the case of a remaining term of more than one year, the realization principle (Article 298 (1) in conjunction with Article 252 (1) no. 4 clause 2 HGB) and the historical cost principle (Article 298 (1) in conjunction with Article 253 (1) sentence 1 HGB) are observed. Bank balances in foreign currencies are translated at the average spot exchange rate on the balance sheet date.

In the consolidated financial statements, the balance sheet items of subsidiaries not reporting in euros are translated in accordance with Article 308a HGB using the modified current-rate method. The asset and liability items of annual financial statements prepared in foreign currencies are translated into euros at the average spot exchange rate on the balance sheet date – with the exception of equity, which is translated at the historical rate. Items in the profit and loss statements of subsidiaries not reporting in euros are translated at the average monthly rate. In accordance with Article 308a HGB, the differences resulting from currency conversion are reported within group equity after reserves under the item "Equity difference from foreign currency translation".

Notes to the consolidated balance sheet

The numbers stated refer to the corresponding item in the consolidated balance sheet or the consolidated profit and loss statement.

1. Fixed assets

The development of fixed assets is shown separately in the statement of changes in fixed assets. Differences resulting from currency translation have been taken into account in the acquisition or manufacturing costs and in the accumulated depreciation. Extraordinary depreciation amounted to k€ 19,363 in the fiscal year.

2. Inventories (after offsetting against down payments received)

in k€	06/30/2023	06/30/2022
Raw materials, consumables and supplies	505,040	419,675
Work in progress	353,623	328,917
Finished goods and merchandise	535,202	478,841
Payments on account	43,353	27,913
Inventories	1,437,218	1,255,346
Down payments received	-386,086	-457,847
Inventories (after offsetting against down payments received)	1,051,132	797,499

3. Receivables

in k€	06/30/2023 Total	Remaining term		Remaining term		
		Up to 1 year	More than 1 year	06/30/2022 Total	Up to 1 year	More than 1 year
Trade receivables	1,089,859	1,045,233	44,626	844,809	806,245	38,564
<i>of which from third parties</i>	1,085,719	1,041,093	44,626	841,776	803,212	38,564
<i>of which from affiliated companies that are not fully consolidated</i>	4,140	4,140	–	3,033	3,033	–
Other receivables	19,612	19,612	–	10,712	10,712	–
<i>of which from affiliated companies that are not fully consolidated</i>	19,450	19,450	–	10,550	10,550	–
<i>of which from associated companies</i>	162	162	–	162	162	–
Total receivables	1,109,471	1,064,845	44,626	855,521	816,957	38,564

4. Other assets

in k€	06/30/2023	06/30/2022
Medium-term financial investments	105,787	232,101
Remaining other assets	179,946	182,558
Other assets	285,733	414,659
<i>of which with a remaining term of more than one year</i>	46,245	113,777

Remaining other assets mainly consist of tax receivables resulting from income tax and value added tax. All financial investments with a maturity of more than three months are reported under medium-term financial investments. Medium-term financial investments amount to k€ 105,787 of which k€ 44,000 have a remaining term of more than one year.

5. Cash and cash equivalents, securities

in k€	06/30/2023	06/30/2022
Securities in current assets	89	75
Cash, bank balances and checks (cash and cash equivalents)	648,628	803,084
	648,717	803,159

Cash and cash equivalents include short-term financial investments with a maturity of up to three months.

6. Prepaid expenses

Prepaid expenses include vacation allowances, insurance premiums, rent, dues, maintenance contracts, and other prepayments caused by the divergent fiscal year.

7. Deferred tax assets

Deferred tax assets and liabilities are disclosed net. The deferred tax assets are the result of consolidation measures. The net deferred tax liabilities result from divergent values in the commercial and the tax financial statement and are mainly attributable to intangible assets, tangible assets and accruals.

in k€	06/30/2023	06/30/2022
Deferred tax assets	64,762	56,431
Deferred tax liabilities	–25,799	–31,459
Surplus	38,963	24,972

8. Equity

in k€	06/30/2023	06/30/2022
Fixed capital	100,000	100,000
Revenue reserves	2,251,478	1,913,378
Consolidated net income attributable to parent company	235,278	218,439
Equity difference from foreign currency translation	93,470	137,316
Minority interests	20,173	17,973
	2,700,399	2,387,106

Fixed capital corresponds to the compulsory contributions of the limited partners of TRUMPF SE + Co. KG. The compulsory contributions of the limited partners are identical to the risk capital.

The subscribed capital of the general partner amounts to k€ 4,000. The revenue reserves comprise profits and losses attributable to domestic and foreign subsidiaries as well as amounts from the offsetting of other consolidation measures.

A pro rata appropriation of profits was already made in the past fiscal year 2022/23 in accordance with the provisions of the partnership agreement. A decision on further appropriation of profits will be made in the following fiscal year. For the fiscal year 2022/23, therefore, as in the previous year, consolidated net income attributable to the parent company is shown.

Minority interests mainly relate to the participation in TRUMPF Hüttinger Sp. z o.o. The result allocable to minority interests comprises profit shares of k€ 6,793 (previous year: k€ 7,007) and loss shares of k€ 0 (previous year: k€ 0). The overall development of consolidated equity is shown separately in the consolidated statement of changes in equity.

9. Special items

The special item relates to investment grants and allowances.

10. Accruals for pensions and similar obligations

in k€	06/30/2023	06/30/2022
Accruals for pensions and similar obligations (settlement value prior to offsetting)	488,681	458,973
Contractual Trust Agreement (offset plan assets)	–245,527	–177,960
	243,154	281,013

The fair value of the offset plan assets corresponds to the amortized acquisition cost. The valuation of the Contractual Trust Agreement as of June 30, 2023 resulted in income of k€ 3,751. This has been offset against the interest expense on pension accruals, which are offset according to Article 246 (2) HGB, of k€ 2,739. The historical acquisition costs of the offset plan assets were k€ 243,331. The difference between the measurement of the obligation at the average market interest rate for ten years and the average market interest rate for seven years amounted to k€ 18,408 as of June 30, 2023 (previous year: k€ 34,923).

11. Other accruals

The fair value of the offset plan assets of the accruals relating to phased retirement programs amounts to k€ 12,661 (previous year: k€ 14,267) and corresponds to amortized acquisition cost. The settlement value of the offset accruals relating to phased retirement programs amounts to k€ 13,605 (previous year: k€ 12,971) on the balance sheet date. The historical acquisition costs of the offset plan assets were k€ 13,348.

The fair value of the offset assets of the accruals for obligations relating to the "TRUMPF Familien- und Weiterbildungskonto" amounts to k€ 35,893 (previous year: k€ 30,721) and corresponds to the amortized acquisition cost. The settlement value of the offset debts also amounts to k€ 35,893 (previous year: k€ 30,721). The historical acquisition costs of the offset plan assets were k€ 32,450.

The netting of expenses and income was waived in each case for reasons of materiality.

in k€	06/30/2023	06/30/2022
Tax accruals	57,006	69,589
Other accruals	608,405	513,241
	665,411	582,830

Other accruals mainly relate to obligations in the personnel and social area, warranty obligations, outstanding purchase invoices and other contingent liabilities.

12. Liabilities

in k€	06/30/2023 Total	Remaining term			Remaining term		
		Up to 1 year	More than 1 year	Of which more than 5 years	06/30/2022 Total	Up to 1 year	More than 1 year
Trade payables	447,677	447,505	172	1	420,367	420,362	5
<i>of which to third parties</i>	444,879	444,707	172	1	417,764	417,759	5
<i>of which to affiliated companies that are not fully consolidated</i>	2,798	2,798	–	–	2,603	2,603	–
Financial liabilities	410,338	209,334	201,004	100,871	319,149	79,424	239,725
<i>of which to banks</i>	344,073	162,745	181,328	98,603	251,399	42,165	209,234
<i>of which other financial liabilities</i>	66,265	46,589	19,676	2,268	67,750	37,259	30,491
Liabilities to partners	279,932	270,421	9,511	–	372,049	259,020	113,029
Other liabilities	143,695	140,862	2,833	36	115,884	113,589	2,295
<i>of which in relation to taxes</i>	73,007	73,007	–	–	53,408	53,408	–
<i>of which in relation to social security</i>	8,996	8,996	–	–	7,539	7,539	–
<i>of which to affiliated companies that are not fully consolidated</i>	13,367	13,367	–	–	5,850	5,850	–
<i>of which remaining other liabilities</i>	48,325	45,492	2,833	36	49,087	46,792	2,295
Total liabilities	1,281,642	1,068,122	213,520	100,908	1,227,449	872,395	355,054

Trade payables are subject to customary retention of title.

Financial liabilities include all interest-bearing liabilities to third parties for financing purposes. Financial liabilities to banks include a promissory note amounting to k€ 205,000 (previous year: k€ 205,000). Other financial liabilities consist of loans and savings deposits.

Of the liabilities to banks, k€ 4,062 (previous year: k€ 5,346) were secured by mortgages.

13. Deferred income

This mainly relates to the deferral of income from maintenance services, training, and leasing contracts, which represent income for a certain period after the balance sheet date.

Notes to the consolidated profit and loss statement

14. Sales revenues

Sales revenues by business division

in k€	2022/23	2021/22
Group	5,364,513	4,222,768
Machine Tools business division	3,038,253	2,288,553
Laser Technology business division	2,059,383	1,608,690
EUV business field	971,317	794,601
Others	488,015	461,776
Consolidation effects	-1,192,455	-930,852

Sales revenues by region

in k€	2022/23	2021/22
Total	5,364,513	4,222,768
Germany	778,633	588,841
Europe (excluding Germany)	2,217,775	1,771,470
Americas	1,167,683	820,413
Asia-Pacific	1,178,968	1,020,555
Others	21,454	21,489

15 percent (previous year: 14 percent) of sales revenues were generated in Germany and 85 percent (previous year: 86 percent) outside Germany.

15. Cost of goods sold

Cost of goods sold (k€ 3,352,520; previous year: k€ 2,555,577) includes all expenses attributable to products or services sold in the fiscal year and the remaining costs of the Production and Service operating divisions that were unable to be assigned to particular products or services. Also included in the cost of goods sold is income of k€ 4,000 (previous year: k€ 0) from the relief amount under the Electricity Price Brake Act (StromPBG).

16. Sales costs

Sales costs amounting to k€ 686,556 (previous year: k€ 547,822) include all personnel expenses allocated to the Sales division, other operating costs such as commissions, travel and marketing costs, depreciation, and material costs for our showrooms. Freight and packaging costs are also included under this item to the extent that they can be allocated to transport from the production plant to the customer.

17. Research and development costs

Research and development costs (k€ 476,315; previous year: k€ 448,007) include all amounts spent on basic research or new developments and not related to current production. These include in particular personnel, non-personnel, and material costs as well as depreciation.

18. General administrative costs

General administrative costs in the fiscal year amount to k€ 281,396 (previous year: k€ 236,772) and include in particular personnel expenses, depreciation and amortization, and other non-personnel costs relating to Management, IT, Human Resources, Legal, Corporate Communications, Infrastructure and Finance.

19. Other operating income

Other operating income mainly includes exchange rate gains, income from the reversal of accruals, income from the reduction of bad debt allowances, and income from asset disposals. A positive extraordinary item from the insurance settlement for last year's plane crash at the Farmington site in the US of k€ 28,491 (previous year: k€ 47,033) as well as public grants and subsidies of k€ 6,476 (previous year: k€ 3,252) is included. Income from foreign currency translation amounts to k€ 226,068 (previous year: k€ 156,411). Other operating income includes income relating to other periods amounting to k€ 47,618 (previous year: k€ 25,264) This is mainly income from the reversal of accruals.

20. Other operating costs

Other operating costs mainly include exchange rate losses, amortization of goodwill, bad debt expenses, additions to individual and lump-sum bad debt allowances, and operating costs that cannot be clearly allocated to any other functional area. Expenses from foreign currency translation amount to k€ 204,252 (previous year: k€ 142,588). Expenses for provisions for onerous contracts from financial instruments are included in the amount of k€ 129 (previous year: k€ 2,217). Other operating costs include expenses relating to other periods amounting to k€ 4,370 (previous year: k€ 310). Other operating costs of k€ 6,197 (previous year: k€ 27,339) are attributable to the plane crash at the Farmington site in the US.

21. Financial and investment result

in k€	2022/23	2021/22
Income from securities and loans	686	1,510
<i>of which from affiliated companies that are not fully consolidated</i>	489	131
Income from participations	10,426	1,074
<i>of which from affiliated companies that are not fully consolidated</i>	–	1
Other interest and similar income	12,579	8,107
<i>of which from affiliated companies that are not fully consolidated</i>	461	64
Write-downs on financial assets and securities	–9	–47
Expenses from loss transfers	–13,367	–7,572
<i>of which from affiliated companies that are not fully consolidated</i>	–13,367	–7,572
Interest and similar expenses	–19,211	–66,903
<i>of which from affiliated companies that are not fully consolidated</i>	–76	–1,711
<i>of which from compounding of accruals</i>	–4,511	–32,960
	–8,896	–63,831

22. Taxes on income

TRUMPF SE + Co. KG and its domestic and foreign subsidiaries are subject to effective and deferred trade and corporate income taxes. The effective tax expenses in the year under review amount to k€ 160,547 (previous year: k€ 116,910).

Income from deferred taxes amounts to k€ 13,743 in the fiscal year (previous year: k€ 17,552). These result from differences in the carrying amounts in the commercial and tax balance sheet and from consolidation measures.

In accordance with Article 264c (3) HGB, the partners' taxes on income have been presented for information purposes after the consolidated net income for the year. They are not included in the calculation of deferred taxes.

23. Personnel costs

The expense items in the profit and loss statement include personnel costs in the following amounts:

in k€	2022/23	2021/22
Wages and salaries	1,261,597	1,104,536
Social security and other welfare costs	224,179	196,040
Expenditure on pension schemes	39,140	33,349
	1,524,916	1,333,925

Notes to the cash flow statement

24. Composition of cash in hand

Cash in hand includes cash and cash equivalents (k€ 648,628), and liabilities to banks payable on demand (k€ 733).

Short-term investments can be converted into cash within a maximum of three months. Liabilities to banks payable on demand relate to bank overdrafts.

Other disclosures

25. Contingent liabilities

in k€	06/30/2023
Liabilities from bills of exchange	6,545
Liabilities from warranty agreements	6,740
Liabilities from guarantees	109,709
<i>of which from affiliated companies that are not fully consolidated</i>	4,968
	122,994

With regard to the sound financial position of the companies for which guarantees and warranty agreements have been assumed, the risk of claims arising from contingent liabilities is considered to be low.

26. Derivative financial instruments and valuation units

in k€	Nominal amount	Fair value
Foreign exchange-related transactions	693,385	–10,771

Foreign exchange-related transactions are forward exchange transactions in the currency pairs EUR/JPY, EUR/KRW, EUR/USD, EUR/CZK, EUR/PLN, and EUR/GBP.

Appropriate accruals have been made for hedging transactions that were not included in valuation units and have a negative fair value on the balance sheet date. The valuation is carried out using generally accepted valuation methods such as present value models.

The following valuation units have been formed:

Underlying transaction/hedging transaction	Risk/type of valuation unit	Included amount	Hedged amount	Hedged risk	Hedge scope ¹⁾	Hedging time frame
Third-party receivables/ Forward exchange transactions	Foreign exchange risk/Macro hedge	k€ 100,580	kJPY 12,540,000	–	47 %	06/17/2026
Third-party receivables/ Forward exchange transactions	Foreign exchange risk/Macro hedge	k€ 50,200	kKRW 68,563,580	–	35 %	06/10/2024
Third-party receivables/ Liabilities to suppliers/ Forward exchange transactions	Foreign exchange risk/Macro hedge	k€ 428,936	kUSD 480,300	k€ –10,557	83 %	06/17/2026
Liabilities to suppliers/ Foreign exchange spread options	Foreign exchange risk/Macro hedge	k€ 12,936	kGBP 11,631	–	100 %	06/17/2026
Liabilities to suppliers/ Forward exchange transactions	Foreign exchange risk/Macro hedge	k€ 12,000	kCZK 280,027	k€ –20	24 %	06/19/2024
Liabilities to suppliers/ Forward exchange transactions	Foreign exchange risk/Macro hedge	k€ 88,733	kPLN 456,857	k€ –194	64 %	06/17/2026

¹⁾ Hedge scope for the fiscal year 2023/24

Regarding the valuation units existing on the balance sheet date in accordance with Article 254 HGB, the following applies:

Economic hedging relationships are reflected on the balance sheet through the formation of valuation units. Due to the consistency of the main value-determining components, the opposing changes in value between the underlying and hedging transactions offset each other completely across the entire hedging period. Regular monitoring is carried out as part of the existing risk management system to measure the effectiveness or

ineffectiveness of hedging measures. This is determined using the critical term match method, which involves checking that the main value-determining components such as currency pair, maturity period, and nominal amounts are consistent. Furthermore, the cash flows from the underlying transactions are retrospectively compared with the payments from the currency hedges. No material ineffectiveness was identified in the year under review.

For hedges of underlying transactions recognized on the balance sheet, the gross hedge presentation method is generally applied, i.e. both the underlying transactions and the hedging transactions are measured as of the reporting date. Opposing and offsetting changes in the value of underlying and hedging transactions are recorded in the profit and loss statement on a gross basis. For hedges of underlying transactions not recognized on the balance sheet, derivatives are not recognized as pending transactions (net hedge presentation method).

Any necessary adjustments to the hedging strategy are made promptly. An effective hedging relationship can therefore be assumed both prospectively and retrospectively.

In order to hedge currency risks from highly probable transactions, forward exchange transactions that correspond to the expected net cash flow in terms of maturity period, nominal amount, and foreign currency (macro hedges) are concluded. The highly probable cash inflows and outflows from planned purchasing and sales transactions are derived from the corporate planning process. A review of past planning has shown that the recognized transactions are highly probable. The forward exchange transactions were concluded for the period from fiscal year 2023/24 to fiscal year 2025/26.

Freestanding derivatives without a valuation unit exist for the currency pair EUR/CNY. These are forward exchange transactions with a nominal value of kCNY 419,086. The countervalue amounts to k€ 55,351. A provision for onerous contracts in the amount of the negative market value has been formed and recognized at a carrying amount of k€ -30 under the balance sheet item other accruals. The market value was determined using a recognized valuation method (present value method).

For freestanding derivatives, especially for the currency pair EUR/USD, a provision for onerous contracts in the amount of the negative market value has been formed and recognized at a carrying amount of k€ -92 under the balance sheet item other accruals. The market value was determined using a recognized valuation method (present value method).

27. Off-balance sheet transactions

In the year under review, there were off-balance sheet transactions in the form of operating lease agreements. These mainly relate to motor vehicles and office equipment and were concluded for cost efficiency reasons. Ongoing leasing installments in the fiscal year 2022/23 total k€ 11,980.

28. Other financial obligations

in k€	06/30/2023
Rent, lease and leasing agreements as well as other obligations	105,232
Purchase commitments for capital projects in progress	77,601
Take back obligations	10,408
	193,241

In addition to the financial commitments listed above, obligations from master agreements and regular purchase commitments exist in the course of ongoing business to a customary extent.

29. Auditor's fee

The total fee charged by the Group's auditor PricewaterhouseCoopers GmbH for the fiscal year can be broken down as follows:

in k€	2022/23	2021/22
Audit of financial statements	954	863
Other attestation services	37	11
Tax consulting services	118	162
Other services	2,021	4,143
	3,130	5,179

30. Employees

The average headcount during the year was:

	2022/23	2021/22
Production	6,166	5,205
Service	3,575	3,328
Research and Development	2,788	2,596
Sales	2,889	2,577
Administration	1,855	1,667
Trainees	550	521
	17,823	15,894

31. Managing Board

TRUMPF SE + Co. KG is managed by its general partner, which is represented by the persons stated below:

- Dr. phil. Nicola Leibinger-Kammüller, President and Chairwoman
- Dr.-Ing. E. h. Peter Leibinger, Vice Chairman, until June 30, 2023
- Dr. rer. pol. Lars Grünert
- Dr.-Ing. Mathias Kammüller
- Dipl.-Betriebsw. Oliver Maassen
- Dr.-Ing. Stephan Mayer
- Dr. rer. nat. Berthold Schmidt, from July 1, 2023
- Dr.-Ing. Christian Schmitz, until June 30, 2023
- Dr. rer. nat. Hagen Zimer, from July 1, 2023

The remuneration of the Managing Board of Berthold Leibinger SE for the performance of their duties in the parent company and the subsidiaries amounted to k€ 16,879 (previous year: k€ 15,395).

Pension commitments of k€ 15,613 (previous year: k€ 14,110) were granted and accrued to former members of management. In the fiscal year 2022/23, former managing directors their surviving dependents received emoluments amounting to k€ 974 (previous year: k€ 781).

32. Exemption in accordance with the German Commercial Code

For the following corporations, use has been made of the exemption under Article 264 (3) HGB: TRUMPF Campus 1 GmbH, TRUMPF Werkzeugmaschinen Deutschland Vertrieb + Service Beteiligungs-GmbH, TRUMPF Werkzeugmaschinen Teningen GmbH, TRUMPF International Beteiligungs-GmbH, TRUMPF Laser- und Systemtechnik GmbH, TRUMPF Hüttinger Verwaltung GmbH, TRUMPF Laser GmbH, Celta Verwaltung-GmbH, TRUMPF Lasertechnik GmbH, TRUMPF Finance GmbH, Berthold Leibinger Immobilien GmbH, TRUMPF Kapitalbeteiligungen GmbH, TRUMPF Sachsen GmbH, TRUMPF Scientific Lasers Verwaltungsgesellschaft mbH, INGENERIC GmbH, TRUMPF Lasersystems for Semiconductor Manufacturing GmbH, TRUMPF New Business GmbH, Amphos GmbH, TRUMPF Tracking Technologies GmbH.

For the following commercial partnerships within the meaning of Article 264a (1) HGB, use has been made of the exemption from the requirement to prepare annual financial statements pursuant to Article 264b HGB in accordance with the provisions applicable to corporations: TRUMPF SE + Co. KG, TRUMPF Werkzeugmaschinen SE + Co. KG, TRUMPF Hüttinger GmbH + Co. KG, TRUMPF Immobilien GmbH + Co. KG, TRUMPF Werkzeugmaschinen Deutschland Vertrieb + Service GmbH + Co. KG, TRUMPF Scientific Lasers GmbH + Co. KG.

33. Consolidated financial statements

TRUMPF SE + Co. KG, Ditzingen, prepares consolidated financial statements for the biggest and smallest group of companies. The consolidated statements can be viewed via the German Electronic Federal Gazette (Unternehmensregister).

34. Related party transactions

All transactions with related parties were at arm's length.

35. Appropriation of earnings

A pro rata appropriation of profits was already made in the past fiscal year 2022/23 in accordance with the provisions of the partnership agreement. A decision on further appropriation of profits will be made in the following fiscal year.

36. Supplementary report

No events of particular significance for the consolidated financial statements have occurred since the end of the fiscal year.

Ditzingen, September 4, 2023

TRUMPF SE + Co. KG represented by its general partner, Berthold Leibinger SE, the latter represented by the Managing Board

Dr. phil. Nicola Leibinger-Kammüller, President and Chairwoman
 Dr. rer. pol. Lars Grünert
 Dr.-Ing. Mathias Kammüller
 Dipl.-Betriebsw. Oliver Maassen
 Dr.-Ing. Stephan Mayer
 Dr. rer. nat. Berthold Schmidt
 Dr. rer. nat. Hagen Zimer

Development of Consolidated Fixed Assets

for fiscal year 2022/23

in k€	Acquisition and manufacturing costs							Accumulated depreciation and amortization								Book value	
	07/01/2022	Changes attributable to currency translation effects	Changes in the scope of consolidation	Additions	Disposals	Reclassifications	06/30/2023	07/01/2022	Changes attributable to currency translation effects	Changes in the scope of consolidation	Additions	Disposals	Reclassifications	Write-ups	06/30/2023	06/30/2023	06/30/2022
INTANGIBLE ASSETS																	
Acquired concessions, industrial and similar rights, licenses	245,443	-7,411	-	4,570	-3,913	838	239,527	-195,268	6,808	-	-19,328	3,592	1	-	-204,195	35,332	50,175
Goodwill	255,446	-8,254	-	617	-	-	247,809	-178,551	8,081	-	-31,293	-	-	-	-201,763	46,046	76,895
Payments on account	756	-	-	225	-48	-746	187	-	-	-	-	-	-	-	187	756	
	501,645	-15,665	-	5,412	-3,961	92	487,523	-373,819	14,889	-	-50,621	3,592	1	-	-405,958	81,565	127,826
TANGIBLE ASSETS																	
Land and buildings	1,266,167	-19,935	-	62,136	-7,920	139,804	1,440,252	-475,080	5,241	-	-52,162	1,358	509	-	-520,134	920,118	791,087
Technical equipment and machines	602,672	-12,181	-	131,676	-64,423	13,560	671,304	-343,581	8,643	-	-75,346	43,802	58	-	-366,424	304,880	259,091
Other equipment, factory and office equipment	584,590	-6,265	1,824	97,173	-28,915	9,856	658,263	-405,016	4,275	-278	-58,021	25,477	-568	67	-434,064	224,199	179,574
Payments on account and assets under construction	207,744	-683	-	135,463	-15,655	-163,312	163,557	-3,968	56	-	-5,407	5,315	-	-	-4,004	159,553	203,776
	2,661,173	-39,064	1,824	426,448	-116,913	-92	2,933,376	-1,227,645	18,215	-278	-190,936	75,952	-1	67	-1,324,626	1,608,750	1,433,528
FINANCIAL ASSETS																	
Shares in affiliated companies	43,562	-15	-4,300	1,144	-2,126	-	38,265	-3,465	9	-	-	-	-	-	-3,456	34,809	40,097
Shares in associated companies	12,691	-4	-	10,674	-38	-	23,323	-95	-	-	-	-	-	-	-95	23,228	12,596
Loans to affiliated companies	9,233	-	-1,250	27,100	-16,800	-	18,283	-	-	-	-	-	-	-	-	18,283	9,233
Participations	6,036	-8	-	126	-5,087	-	1,067	-50	8	-	-	-	-	-	-42	1,025	5,986
Long-term investments	1,093	18	-	-	-	-	1,111	-809	-13	-	-9	-	-	-	-831	280	284
Other loans	26,805	7	-	71,017	-25,373	-	72,456	-	-	-	-	-	-	-	-	72,456	26,805
	99,420	-2	-5,550	110,061	-49,424	-	154,505	-4,419	4	-	-9	-	-	-	-4,424	150,081	95,001
TOTAL	3,262,238	-54,731	-3,726	541,921	-170,298	-	3,575,404	-1,605,883	33,108	-278	-241,566	79,544	-	67	-1,735,008	1,840,396	1,656,355

List of Shareholdings

as of June 30, 2023

Company	Share of ownership TRUMPF SE + Co. KG in percent	
	Direct	Indirect
Fully consolidated subsidiaries		
Leibinger SE, Ditzingen	100	
TRUMPF Campus 1 GmbH (previously: TRUMPF Werkzeugmaschinen Beteiligungs-GmbH), Ditzingen	100	
TRUMPF Werkzeugmaschinen SE + Co. KG, Ditzingen	100	
TRUMPF Werkzeugmaschinen Deutschland Vertrieb + Service GmbH + Co. KG, Ditzingen ¹		100
TRUMPF International Beteiligungs-GmbH, Ditzingen	100	
TRUMPF Werkzeugmaschinen Deutschland Vertrieb + Service Beteiligungs-GmbH, Ditzingen		100
TRUMPF Laser- und Systemtechnik GmbH, Ditzingen		100
TRUMPF Hüttinger Verwaltung GmbH, Freiburg i. Br.		90
TRUMPF Hüttinger GmbH + Co. KG, Freiburg i. Br. ¹		90
TRUMPF Lasersystems for Semiconductor Manufacturing GmbH, Ditzingen		100
TRUMPF Sachsen GmbH, Neukirch		100
TRUMPF Laser GmbH, Schramberg		100
Celtia Verwaltungs-GmbH, Reutlingen		100
TRUMPF Financial Services GmbH, Ditzingen	100	
TRUMPF Lasertechnik GmbH, Ditzingen	100	
TRUMPF Finance GmbH, Ditzingen	100	
TRUMPF VSZ Grundstücksverwaltungsgesellschaft mbH + Co. KG, Mainz ²	94	
Berthold Leibinger Immobilien GmbH, Ditzingen	100	
TRUMPF Immobilien GmbH + Co. KG, Ditzingen ¹	100	
Hüttinger Grundstücks-Vermietungsgesellschaft mbH + Co. Objekt Freiburg KG, Pullach i. Isartal ²		90
TRUMPF Kapitalbeteiligungen GmbH, Ditzingen		100
TRUMPF Scientific Lasers Verwaltungs-GmbH, Unterföhring		100
TRUMPF Scientific Lasers GmbH + Co. KG, Unterföhring ¹		100
INGENERIC GmbH, Baesweiler		100
TRUMPF Werkzeugmaschinen Teningen GmbH, Teningen		100
Amphos GmbH, Herzogenrath		100
TRUMPF Photonic Components GmbH, Ulm		100
TRUMPF New Business GmbH, Ditzingen	100	
TRUMPF Tracking Technologies GmbH, Ditzingen		100
TRUMPF Schweiz AG, Grösch, Switzerland		100
TRUMPF Finance (Schweiz) AG, Baar, Switzerland	100	
TRUMPF Inc., Farmington, Connecticut, USA		100
TRUMPF Huettinger Inc., Santa Clara, California, USA		90
TRUMPF Photonics, Inc., Cranbury, New Jersey, USA		100
TRUMPF Limited, Luton, United Kingdom		100
TRUMPF Laser plc, Southampton, United Kingdom		100
TRUMPF Laser UK Ltd., Southampton, United Kingdom		100
TRUMPF Laser & Machinery Ireland Ltd., Dublin, Ireland		100
TRUMPF Corporation, Yokohama, Japan		100
TRUMPF S.A.S., Paris, France		100

Company	Share of ownership TRUMPF SE + Co. KG in percent	
	Direct	Indirect
TRUMPF Machines S.A.R.L., Haguenau, France		100
TRUMPF Máquinas Ind. E. Com. Ltda., São Paulo, Brazil		100
Auroma Technologies Co. DbA Access Laser Company, Everett, Washington, USA		100
Stellar Industries Corp., Wilmington, Delaware, USA		100
TRUMPF maskin ab, Alingsås, Sweden		100
TRUMPF Maquinaria S.A., Madrid, Spain		100
TPT Máquinas-Ferramentas e Laser, Unipessoal, Lda, Porto Salvo, Portugal		100
TRUMPF Maschinen Austria GmbH, Pasching, Austria		100
TRUMPF Maschinen Austria GmbH & Co. KG, Pasching, Austria ¹		100
TRUMPF S.r.l. (previously: TRUMPF Homberger S.r.l.), Buccinasco (Milan), Italy		100
TRUMPF Macchine Italia S.r.l., Lonigo (Vicenza), Italy		100
TRUMPF Additive Manufacturing Italia S.r.l., Piovene Rocchelle (Vicenza), Italy		100
TRUMPF Pte Ltd., Singapore, Singapore		100
TRUMPF Korea Co., Ltd., Seoul, South Korea		100
TRUMPF Malaysia Sdn Bhd, Kuala Lumpur, Malaysia		100
TRUMPF (India) Private Limited, Pune, India		100
TRUMPF Metamation Private Limited, Siruseri, India		100
TRUMPF Praha spol. s.r.o., Prague, Czech Republic		100
TRUMPF Strojírenská výroba CZ s.r.o., Liberec, Czech Republic		100
TRUMPF Liberec, spol. s.r.o., Liberec, Czech Republic		100
TRUMPF Shared Services sp. z o.o., Warsaw, Poland		100
TRUMPF Polska Sp. z o.o. Sp. k., Warsaw, Poland ¹		100
TRUMPF Polska Sp. z o.o., Warsaw, Poland		100
TRUMPF Huettinger Sp. z o.o., Zielonka, Poland		90
TRUMPF Hungary Kft, Gödöllő, Hungary		100
TRUMPF Bulgaria Ltd., Sofia, Bulgaria		100
TRUMPF Laser + Machinery S.R.L., Bucharest, Romania		100
TRUMPF Sheet Metal Products (Taicang) Co., Ltd., Taicang, China		100
TRUMPF (China) Co., Ltd., Taicang, China		100
TRUMPF HUETTINGER Electronics (Taicang) Co. Ltd. (previously: HUETTINGER Electronics (Shanghai) Co., Ltd.), Taicang, China		90
Jiangsu Jinfangyuan CNC Machine Co., Ltd., Yangzhou City Jiangsu Province, China		100
TRUMPF Technology (Shanghai) Co., Ltd., Shanghai, China		100
TRUMPF Mexico S. de R.L. de C.V., Apodaca, Mexico		100
JFY Mexico S. de R.L. de C.V. (previously: TRUMPF Mexico Services S. de R.L. de C.V.), Apodaca, Mexico		100
TRUMPF Slovakia, s.r.o., Košice, Slovakia		100
TRUMPF Canada Inc., Mississauga, Ontario, Canada		100
TRUMPF Nederland B.V., Hengelo, Netherlands		100
TRUMPF Photonic Components B.V., Eindhoven, Netherlands		100
TRUMPF OOO, Moscow, Russia		100
TRUMPF Taiwan Industries Co., Ltd., Gueishan Dist., Taoyuan City, Taiwan		100
PT. TRUMPF Indonesia, Jakarta, Indonesia		100
TRUMPF Philippines Inc., Manila, Philippines		100
TRUMPF Ltd., Bangkok, Thailand		100
TRUMPF VIETNAM COMPANY LIMITED, Ho Chi Minh City, Vietnam		100
TRUMPF Makina Sanayii A.Ş., Istanbul, Turkey		100
Lantek Sheet Metal Solutions, S.L., Miñano Menor/Álava, Spain		100
Companies not included in the consolidated financial statements		
TMT SE, Ditzingen	100	
TRUMPF Smart Factory Consulting GmbH (previously: XETICS GmbH, Ditzingen)		100
JT Optical Engine Verwaltungs-GmbH, Jena ³		50
Findos SC Investor Fund II GmbH & Co. KG, Munich		24.995

Company	Share of ownership TRUMPF SE + Co. KG in percent	
	Direct	Indirect
Quant GmbH, Stuttgart		100
One Click Metal GmbH, Tamm		49.9
ZIGPOS GmbH, Dresden		51.3275
Optimate GmbH, Stuttgart		100
ScaleNC GmbH, Stuttgart		100
FETEX Grundstücks-Vermietungsgesellschaft mbH, Freiburg i.Br.		100
TRUMPF Venture II GmbH, Ditzingen		100
Active Fiber Systems GmbH, Jena		80
TRUMPF Quantum Beteiligungen-SE, Ditzingen	100	
STOPA Anlagenbau GmbH, Achern		25.1
Stopa Storage & Parking Technologies (Changzhou) Co., Ltd., Jintan Changzhou, China		25.1
Stopa America Inc., Burlington, Connecticut, USA		25.1
SICK INTERNATIONAL GMBH i.L., Emmendingen ³		25.1
Sick international Kellereimaschinen GmbH i.L., Emmendingen ³		25.1
Stolzer Parkhaus GmbH u. Co. KG i.L., Achern ³		25.1
Stolzer Parkhaus Verwaltungs-GmbH i.L., Achern ³		25.1
WCF Industriebeteiligungs-GmbH, Ottersweier		12.299
Seeger Schweißtechnik GmbH i.L., Germersheim ³		12.55
sus.raw GmbH, Ditzingen		27.5
Toref Technica Co., Ltd., Aichi, Japan		25
TRUMPF Colombia S.A.S, Bogotá, Colombia		100
CT Crystals, LLC, Wilmington, Delaware, USA		50
TVDO I AG, Vienna, Austria		100
TVDO II AG, Vienna, Austria		100
TVDO III AG, Vienna, Austria		100
TVDO IV AG, Vienna, Austria		100
TVDO V AG, Vienna, Austria		100
TVDO VI AG, Vienna, Austria		100
STARMATIK s.r.l., Spresiano, Italy		25.1
ACCESS LASER (SHENZHEN) CO.,LTD, Shenzhen, China		100
SHENZHEN EVERBRITE CD.,LTD, Shenzhen, China		100
TRUMPF Engineering Services Italy S.r.l., Orbassano/Turin, Italy		87.5
Bruma Machinehandel B.V., Spankeren, Netherlands		100
TRUMPF Laser Israel Limited, Tel Aviv, Israel		100
Lantek Polska Sp. z o.o., Katowice, Poland		100
Lantek Yazılım Ticaret Limited Şirketi, Nilüfer/Bursa, Turkey		100
Lantek Mexico, S.A. de C.V., México D.F., Mexico		100
Lantek (Shanghai) Trading Co., Ltd., Shanghai, China		100
Lantek Systems Limited, Malvern/Worcestershire, United Kingdom		100
Lantek Systemes SARL, Vienne Cedex, France		100
Lantek Systems, Inc., Mason, Ohio, USA		100
LANTEK Systemtechnik GmbH, Darmstadt		100
Lantek System Korea LLC, Sasang-gu/Busan, South Korea		100
LANTEK AUSTRALIA PTY LTD, Melbourne, Australia		100
c2go inprocess solutions GmbH i.L., Berlin ³		100
Amphos Inc, Wilmington, Delaware, USA		100

¹ Entities whose general partner is included in the group of consolidated companies

² Companies are consolidated as, from an economic standpoint, the opportunities and risks accrue to the parent company

³ In liquidation

This audit report is issued on the financial statements prepared in German language.

Independent Auditor's Report

To TRUMPF SE + Co. KG, Ditzingen

Audit Opinions

We have audited the consolidated financial statements of TRUMPF SE + Co. KG, Ditzingen, and its subsidiaries (the Group), which comprise the consolidated balance sheet as at 30 June 2023, and the consolidated income statement, consolidated statement of changes in equity and consolidated cash flow statement for the financial year from 1 July 2022 to 30 June 2023, and notes to the consolidated financial statements, including the presentation of the recognition and measurement policies. In addition, we have audited the group management report of TRUMPF SE + Co. KG for the financial year from 1 July 2022 to 30 June 2023.

In our opinion, on the basis of the knowledge obtained in the audit,

- the accompanying consolidated financial statements comply, in all material respects, with the requirements of German commercial law and the supplementary provisions of the Articles of Association and give a true and fair view of the assets, liabilities and financial position of the Group as at 30 June 2023 and of its financial performance for the financial year from 1 July 2022 to 30 June 2023 in compliance with German Legally Required Accounting Principles, and

- the accompanying group management report as a whole provides an appropriate view of the Group's position. In all material respects, this group management report is consistent with the consolidated financial statements, complies with German legal requirements and appropriately presents the opportunities and risks of future development.

Pursuant to § [Article] 322 Abs. [paragraph] 3 Satz [sentence] 1 HGB [Handelsgesetzbuch: German Commercial Code], we declare that our audit has not led to any reservations relating to the legal compliance of the consolidated financial statements and of the group management report.

Basis for the Audit Opinions

We conducted our audit of the consolidated financial statements and of the group management report in accordance with § 317 HGB in compliance with German Generally Accepted Standards for Financial Statement Audits promulgated by the Institut der Wirtschaftsprüfer [Institute of Public Auditors in Germany] (IDW). Our responsibilities under those requirements and principles are further described in the "Auditor's Responsibilities for the Audit of the Consolidated Financial

Statements and of the Group Management Report” section of our auditor’s report. We are independent of the group entities in accordance with the requirements of German commercial and professional law, and we have fulfilled our other German professional responsibilities in accordance with these requirements. We believe that the audit evidence we have obtained is sufficient and appropriate to provide a basis for our audit opinions on the consolidated financial statements and on the group management report.

Other Information

The executive directors are responsible for the other information.

The other information comprises the annual report – excluding cross-references to external information – with the exception of the audited consolidated financial statements, the audited group management report and our auditor’s report.

Our audit opinions on the consolidated financial statements and on the group management report do not cover the other information, and consequently we do not express an audit opinion or any other form of assurance conclusion thereon.

In connection with our audit, our responsibility is to read the other information mentioned above and, in so doing, to consider whether the other information

- is materially inconsistent with the consolidated financial statements, with the group management report disclosures audited in terms of content or with our knowledge obtained in the audit, or
- otherwise appears to be materially misstated.

Responsibilities of the Executive Directors for the Consolidated Financial Statements and the Group Management Report

The executive directors are responsible for the preparation of the consolidated financial statements that comply, in all material respects, with the requirements of German commercial law, and that the consolidated financial statements give a true and fair view of the assets, liabilities, financial position and financial performance of the Group in compliance with German Legally Required Accounting Principles. In addition, the executive directors are responsible for such internal control as they, in accordance with German Legally Required Accounting Principles, have determined necessary to enable the preparation of consolidated financial statements that are free from material misstatement, whether due to fraud (i.e., fraudulent financial reporting and misappropriation of assets) or error.

In preparing the consolidated financial statements, the executive directors are responsible for assessing the Group’s ability to continue as a going concern. They also have the responsibility for disclosing, as applicable, matters related to going concern. In addition, they are responsible for financial reporting based on the going concern basis of accounting, provided no actual or legal circumstances conflict therewith.

Furthermore, the executive directors are responsible for the preparation of the group management report that, as a whole, provides an appropriate view of the Group’s position and is, in all material respects, consistent with the consolidated financial statements, complies with German legal requirements, and appropriately presents the opportunities and risks of future development. In addition, the executive directors are responsible for such arrangements and measures (systems) as they have considered necessary to enable the preparation of a group management report that is in accordance with the applicable German legal requirements, and to be able to provide sufficient appropriate evidence for the assertions in the group management report.

Auditor’s Responsibilities for the Audit of the Consolidated Financial Statements and of the Group Management Report

Our objectives are to obtain reasonable assurance about whether the consolidated financial statements as a whole are free from material misstatement, whether due to fraud or error, and whether the group management report as a whole provides an appropriate view of the Group’s position and, in all material respects, is consistent with the consolidated financial statements and the knowledge obtained in the audit, complies with the German legal requirements and appropriately presents the opportunities and risks of future development, as well as to issue an auditor’s report that includes our audit opinions on the consolidated financial statements and on the group management report.

Reasonable assurance is a high level of assurance, but is not a guarantee that an audit conducted in accordance with § 317 HGB and in compliance with German Generally Accepted Standards for Financial Statement Audits promulgated by the Institut der Wirtschaftsprüfer (IDW) will always detect a material misstatement. Misstatements can arise from fraud or error and are considered material if, individually or in the aggregate, they could reasonably be expected to influence the economic decisions of users taken on the basis of these consolidated financial statements and this group management report.

We exercise professional judgment and maintain professional skepticism throughout the audit. We also:

- Identify and assess the risks of material misstatement of the consolidated financial statements and of the group management report, whether due to fraud or error, design and perform audit procedures responsive to those risks, and obtain audit evidence that is sufficient and appropriate to provide a basis for our audit opinions. The risk of not detecting a material misstatement resulting from fraud is higher than for one resulting from error, as fraud may involve collusion, forgery, intentional omissions, misrepresentations, or the override of internal controls.
- Obtain an understanding of internal control relevant to the audit of the consolidated financial statements and of arrangements and measures (systems) relevant to the audit of the group management report in order to design audit procedures that are appropriate in the circumstances, but not for the purpose of expressing an audit opinion on the effectiveness of these systems.
- Evaluate the appropriateness of accounting policies used by the executive directors and the reasonableness of estimates made by the executive directors and related disclosures.
- Conclude on the appropriateness of the executive directors’ use of the going concern basis of accounting and, based on the audit evidence obtained, whether a material uncertainty exists related to events or conditions that may cast significant doubt on the Group’s ability to continue as a going concern. If we conclude that a material uncertainty exists, we are required to draw attention in the auditor’s report to the related disclosures in the consolidated financial statements and in the group management report or, if such disclosures are inadequate, to modify our respective audit opinions. Our conclusions are based on the audit evidence obtained up to the date of our auditor’s report. However, future events or conditions may cause the Group to cease to be able to continue as a going concern.
- Evaluate the overall presentation, structure and content of the consolidated financial statements, including the disclosures, and whether the consolidated financial statements present the underlying transactions and events in a manner that the consolidated financial statements give a true and fair view of the assets, liabilities, financial position and financial performance of the Group in compliance with German Legally Required Accounting Principles.

– Obtain sufficient appropriate audit evidence regarding the financial information of the entities or business activities within the Group to express audit opinions on the consolidated financial statements and on the group management report. We are responsible for the direction, supervision and performance of the group audit. We remain solely responsible for our audit opinions.

– Evaluate the consistency of the group management report with the consolidated financial statements, its conformity with German law, and the view of the Group’s position it provides.

– Perform audit procedures on the prospective information presented by the executive directors in the group management report. On the basis of sufficient appropriate audit evidence we evaluate, in particular, the significant assumptions used by the executive directors as a basis for the prospective information, and evaluate the proper derivation of the prospective information from these assumptions. We do not express a separate audit opinion on the prospective information and on the assumptions used as a basis. There is a substantial unavoidable risk that future events will differ materially from the prospective information.

We communicate with those charged with governance regarding, among other matters, the planned scope and timing of the audit and significant audit findings, including any significant deficiencies in internal control that we identify during our audit.

Stuttgart, September 4, 2023

PricewaterhouseCoopers GmbH
Wirtschaftsprüfungsgesellschaft

Marcus Nickel Wirtschaftsprüfer (German Public Auditor)	Kai Mauden Wirtschaftsprüfer (German Public Auditor)
--	---

Imprint

PUBLISHED BY

TRUMPF SE + Co. KG

Corporate Communications,
Public Policy and Brand

IDEA AND EDITORIAL CONTENT

Dr. Andreas Möller (responsible)
Dr. Alexandra Fies (historical
documentation, text image section)
Dr. Manuel Thomä (text image section)
Rainer Berghausen
Magdalena Blisch
Annika Bruckner
Daniela Eberhardt
Dr. Nico Friedrich
Dominik Göring
Marcus Gottuck
Daniela Körber
Angelika Kogel
Andre Kolb
Saskia Knauer
Kathrin Müller
Lena Schuh
Franziska Sigle

CONTACT

TRUMPF SE + Co. KG
Johann-Maus-Strasse 2
71254 Ditzingen
+49 7156 303-0
info@trumpf.com

REALIZATION

Concept and Design:
Strichpunkt GmbH, Stuttgart/Berlin
www.strichpunkt-design.de

Photographs:
Thomas Abe
Volker Arnold
Iwan Baan
Zoey Braun
Corinne Eichbaum
David Franck
Manfred Jarisch
Ralph Lahrmann
Claus Morgenstern
Stefan Müller
Verena Müller
Ansgar Pudenz
Ina Reinecke
Margherita Spiluttini
Martin Stollberg
TRUMPF Group

Repro:
ctrl-s GmbH
www.ctrl-s.de

Printing:
Raff & Cantz Druck GmbH
www.raff-cantz.de

Note

Any reference to the masculine form is made solely for the sake of readability and includes both masculine and feminine.



Business divisions and business fields

OUR ANNUAL REPORTS

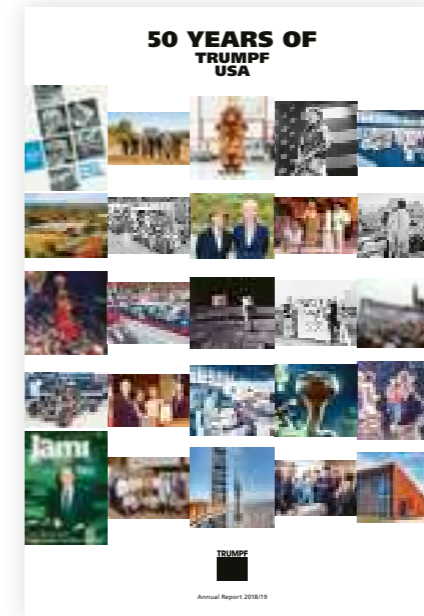

2018/2019



2019/2020



2020/2021



2021/2022

2018 — 2022

Imprint

PUBLISHED BY

TRUMPF SE + Co. KG

Corporate Communications,
Public Policy and Brand

IDEA AND EDITORIAL CONTENT

Dr. Andreas Möller (responsible)
Dr. Alexandra Fies (historical
documentation, text image section)
Dr. Manuel Thomä (text image section)
Rainer Berghausen
Magdalena Blisch
Annika Bruckner
Daniela Eberhardt
Dr. Nico Friedrich
Dominik Göring
Marcus Gottuck
Daniela Körber
Angelika Kogel
Andre Kolb
Saskia Knauer
Kathrin Müller
Lena Schuh
Franziska Sigle

CONTACT

TRUMPF SE + Co. KG
Johann-Maus-Strasse 2
71254 Ditzingen
+49 7156 303-0
info@trumpf.com

Note

Any reference to the masculine form is made solely for the sake of readability and includes both masculine and feminine.



REALIZATION

Concept and Design:
Strichpunkt GmbH, Stuttgart/Berlin
www.strichpunkt-design.de

Photographs:
Thomas Abe
Volker Arnold
Iwan Baan
Zoey Braun
Corinne Eichbaum
David Franck
Manfred Jarisch
Ralph Lahrmann
Claus Morgenstern
Stefan Müller
Verena Müller
Ansgar Pudenz
Ina Reinecke
Margherita Spiluttini
Martin Stollberg
TRUMPF Group

Repro:
ctrl-s GmbH
www.ctrl-s.de

Printing:
Raff & Cantz Druck GmbH
www.raff-cantz.de

Machine Tools

MACHINE TOOLS FOR FLEXIBLE SHEET METAL MANUFACTURING

TRUMPF's largest area of activity is in machine tools for flexible sheet and pipe machining. Our portfolio encompasses systems for bending, punching, combined punch laser processes, and for laser cutting and laser welding tasks. We offer our customers custom-fit machines, automation and networking solutions, consulting, financing and a wide range of services so that they can manufacture their products economically, reliably and to a high quality. With our software solutions, we assist them in all their machining tasks, from design to complete production control.



TruLaser
5030 fiber

Business divisions and business fields

Business divisions



TruMark Station 7000

Laser Technology

LASERS FOR PRODUCTION TECHNOLOGY

Cutting, welding, marking, surface machining: we have exactly the right laser for every industrial application, and the right technology to ensure innovative, yet cost-efficient production. For work at macro, micro, nano or femto level – we take an individual approach to our customers' needs and are at their side offering system solutions, software tools, application expertise, and advice. Our Electronics field offers process power supply units for high-tech applications. Our generators provide electricity for induction heating and plasma and laser excitation, with precisely the right frequency and power our customers require.

Extreme UV Light

HIGH-POWER LASER SYSTEMS FOR EUV LITHOGRAPHY

TRUMPF is developing and producing a unique CO₂ laser system in close cooperation with ASML, the world's largest manufacturer of lithography systems, and ZEISS, the optics manufacturer. High-power lasers from TRUMPF play a key role in the production of the latest generation of microchips: They are used to generate a luminous plasma that delivers extreme ultraviolet (EUV) radiation to expose the wafers.



TRUMPF
EUV system

Additive Manufacturing

ADDITIVE MANUFACTURING FOR INNOVATIVE COMPONENTS

Additive manufacturing enables the simple production of complex parts. TruPrint systems from TRUMPF are used in the aerospace, medical technology, energy and automotive industries. TRUMPF is proficient in the two key metal printing processes: laser metal fusion (LMF) and laser metal deposition (LMD). This means that it can offer customers the solution that best suits their application.



TruPrint
5000

Business fields

Photonic Components

LASER DIODES FOR SENSORS, DATA COMMUNICATION AND HEAT TREATMENT

Laser diodes from the TRUMPF Photonic Components business field are used in smartphones, digital data transmission, and sensors for autonomous driving. Over a billion cell phones worldwide are already equipped with this laser diode technology. In electromobility, the technology is used to dry foils in the production of batteries.



Single and
multi-mode VCSEL

Financial Services

COMPANY-OWNED FULL-SERVICE BANK FOR PURCHASE LOANS

Along with their quote for a machine, TRUMPF customers also receive a lease or hire purchase offer. Our custom-tailored finance solutions are based on financing know-how and expertise in the mechanical engineering industry. The TRUMPF bank is active in nine European countries. For other core markets such as the US and China, TRUMPF collaborates with partners.



Finance concepts for
state-of-the-art
production technology

HOW IT ALL BEGAN



THE FUTURE WITH TRUMPF